

Industrial Pressure and Vacuum Switches

9012G, 9016G, and XMLA, B, C, D

Catalog

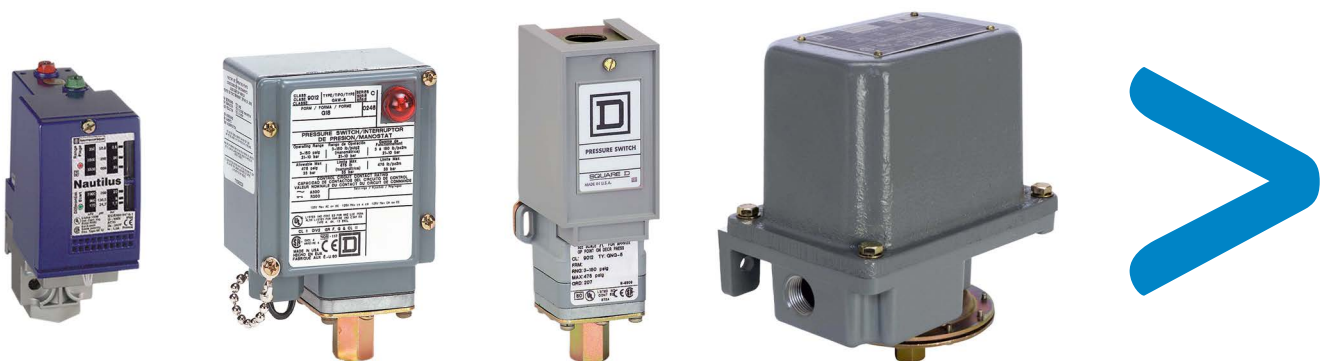

Simply easy!™

Selection Guide	8/2
■ Selecting a pressure switch	6
■ Terminology	8

OsiSense™ XML electromechanical pressure and vacuum switches

■ Introduction	11
■ Selection and specifications	22
■ Accessories	73
■ Dimensions	74
■ Materials in contact with fluid	77

9012G pressure switches

■ Introduction	8/79
■ Technical overview	8/81
■ Selection and specifications	8/85
■ Modifications and accessories	8/91
■ Dimensions	96
■ Renewal parts	98

9016G vacuum switches

■ Selection and specifications	94
■ Dimensions and modifications	99

OsiSense™ XML

Electromechanical pressure and vacuum switches

Applications	Type of installation	Control circuits		
	Media controlled	Air, water, hydraulic oils, corrosive fluids, viscous products		
	Type of operation	Fixed differential: Detection of a single threshold	Adjustable differential: Regulation between two thresholds	Dual-stage switches: Fixed differential, detection at each threshold



Fluid characteristics	Air, fresh water, sea water, corrosive fluids, viscous products, up to 320 °F (160 °C) depending on model			
Size (pressure range)	-1 to 500 bar (-14.5 to 7250 psi)			
Dimensions of case: mm (in.) Width x height x depth	35 x 68 x 75 (1.4 x 2.7 x 3.0)	46 x 68 x 85 (1.8 x 2.7 x 3.3)	35 x 68 x 75 (1.4 x 2.7 x 3.0)	
Type of contacts	1 C/O single-pole, snap action	2 C/O single-pole, simultaneous, snap action	2 C/O single-pole, staggered, snap action	
Degree of protection	IP66 with terminal connections IP65 with plug-in connector	IP66 with terminal connections	IP66 with terminal connections IP65 with plug-in connector	
Agency listings	UL, CSA, CCC, BV, LROS, RINA, GL, DNV, VIT-SEPRO			
Electrical connection	Screw terminals: 1 tapped entry: 1/2 NPT; M20 x 1.5 mm for ISO conduit/cable; or PG 13.5 conduit/cable entry Connector: DIN 43650, M12			
Pressure connection	G 1/4 (BSP female), 1/4" NPTF, PT 1/4 (JIS B0203)			
Catalog number	XMLA	XMLB	XMLC	XMLD
Pages	11			
Other versions	For electromechanical pressure and vacuum switches with alternative tapped cable or fluid entries, consult the Customer Care Center.			

Applications	Type of installation	Control circuits				Power circuits
	Media controlled	Air, water, hydraulic oils (1), gases, steam				
	Type of operation	Fixed differential: Detection of a single threshold	Adjustable differential: Regulation between two thresholds	Differential-pressure: (change in the difference between two pressures)	Dual-stage switches: Fixed differential, detection at each threshold	Vacuum switches for control circuits



Fluid characteristics	up to 248 °F (120 °C)					
Size (pressure range)	Diaphragm: 0.2–675 psi on falling pressure Piston actuated: 20–9,000 psi on falling pressure		0–28.7 inHg	0–25 inHg		
Dimensions of case: mm (in.) Width x height x depth	See page 96 and following pages					
Type of contacts	SPDT or DPDT double break contacts; SPDT single break contacts				DPST (SPDT for Form H)	
Degree of protection	IP66 conforming to IEC 60957					
Agency listings	UL Listed and CSA certified as industrial control equipment					
Electrical connection (enclosed devices)	1/2"-14 NPTF, PG13.5, or ISO M20; 3/4"-14 NPTF available only on NEMA 7 and 9. NEMA 1 is 1/2" conduit entry, unthreaded.		1/2"-14 NPT	3 x 1/2" conduit entry, unthreaded		
Pressure connection	G1/4 (BSP) female, 1/4"-18 NPTF, 1/4-18 NPT internal or external (depending on model), 1/2"-14 NPT					
Catalog number	9012GD, GE, GF, GR, GS, GT	9012GA, GB, GC, GN, GP, GQ	9012GGW, GHW, GJW	9012GKW, GLW, GMW	9016GAW, GAR	9016GVG
Pages	8/85	8/87	8/89	8/90	94	95
Other versions	<i>(1) The hydraulic fluids used for laboratory testing are equivalent to SAE 30 W oils. If oils have less viscosity than this type of oil, leakage can be expected. Schneider Electric does not have test data to support or predict fluid bypass with oils less than SAE 30W.</i>					

Steps for selecting a pressure switch



The deciding factors in the selection of a pressure switch for use on control circuits' depend on the requirements of the application. Consider the following requirements to help determine the appropriate catalog number for your application.

1. Setpoints: Do you want to control/monitor one setpoint or two?

- One setpoint: fixed differential
- Two setpoints: adjustable differential

Fixed differential

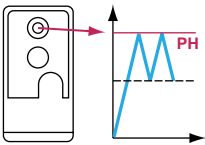

2. Fluids: What fluids do you want to control?

- Hydraulic oil, air, fresh water ≤ 70 °C (158 °F)
- Steam
- Hydraulic oil, air, fresh water ≤ 160 °C (320 °F)
- Corrosive fluid ≤ 160 °C (320 °F)
- Sea water ≤ 70 °C (158 °F)
- Viscous fluid ≤ 160 °C (320 °F)
- Sea water ≤ 160 °C (320 °F)

Adjustable differential

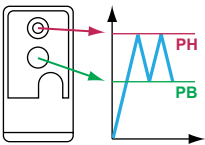

Ensure that the wetted parts of the switch are compatible with the system fluid.

3. Pressure range: What pressure range does the system experience?

Note: Select pressure settings that fall within the middle 80% of the pressure range. The pressure applied during a normal cycle should never exceed the maximum range value listed for the switch. Pressure surges should be less than the maximum allowable pressure listed for the switch.

Rated pressure			
XML		9012G / 9016 G (a)	
psi	bar	psi	bar
-14.5 to -4.06	-1 to -0.28	0 to 28 inHg	
-14.5 to -2.03	-1 to -0.14	0 to 25 inHg	
-2.9 to -0.029	-0.2 to -0.02	5 to 25 inHg (9016GVG only)	
-7.25 to 72.5	-0.5 to 5	0.2 to 10	0.01 to 0.69
0 to 0.725	0 to 0.05	1 to 40	0.07 to 2.76
0 to 5.075	0 to 0.35	1.5 to 75	0.10 to 5.17
0 to 14.5	0 to 1	3 to 150	0.21 to 10.34
0 to 36.25	0 to 2.5	5 to 250	0.34 to 17.24
0 to 58	0 to 4	13 to 425	0.90 to 29.30
0 to 145	0 to 10	20 to 675	1.38 to 46.54
0 to 290	0 to 20	20 to 1000	1.38 to 68.95
0 to 507.5	0 to 35	90 to 2900	6.21 to 199.95
0 to 580	0 to 40	170 to 5600	11.72 to 386.11
0 to 1015	0 to 70	270 to 9000	18.62 to 620.53
0 to 2320	0 to 160	0 to 75 (b)	0 to 5.17 (b)
0 to 4350	0 to 300	0 to 175 (b)	0 to 12.07 (b)
0 to 7250	0 to 500	0 to 500 (b)	0 to 34.47 (b)
		0 to 5000 (b)	0 to 344.74 (b)

(a) For 9016G vacuum switches, the unit of rated pressure is inHg.

(b) Pressure switches for differential-pressure operation.

4. Surges: How frequent are surges in your system, and what is their maximum pressure level? Applications experiencing frequent or high-pressure surges may require a device with a higher pressure range.

5. Differential: The required differential may exclude some pressure range choices.

(1) For switches used on power circuits, see catalog 9013CT9701, *Commercial Pressure Switches, Class 9013 Types F and G.*

6. **Enclosure:** What type of enclosure do you need?
- Open style
 - NEMA Type 1
 - NEMA Type 7, 9
 - NEMA Type 4, 4X, 13 / IP66, IP65
7. **Output:** What output type do you require?
- SPDT contacts, 1 N/O, 1 N/C
 - 2 SPDT contacts, 1 N/O, 1 N/C
 - Dual stage, 1 SPDT contact each stage, 1 N/O, 1 N/C
 - Horsepower rated, 9016GVG vacuum switch only
8. **Electrical connection:** What type of electrical connection do you require?
- ½"- 14 NPTF
 - ISO M20 metric threads
 - Type 13 (PG 13.5) metric threads
 - ¾"-14 NPTF (available only on NEMA 7 & 9)
 - No threaded connection (open style or NEMA 1 only)
9. **Pressure connection:** What type of pressure connection do you require?
- ¼"- 18 NPTF (female)
 - ½" - 14 NPT
 - G 1/4 BSP (female) metric thread
 - PT ¼ (JIS B0203)
 - 7/16"-20 UNF-2B
10. **Special features:** Do you require any special features?

See the modification table on page 8/91 for available modifications for 9012 and 9016G pressure switches. (Form designations are added to the end of the part number of the standard device for these products.) Some examples are:

- Pilot light
- Prewired receptacles
- External range adjustment
- Range scale window
- Special factory pressure settings
- Pressure connections

When switches must be factory set and only one setting is identified, specify whether this setting is on rising or falling pressure. See "Special factory setting specified (If indicating only one special setting, specify whether this setting is on increasing or decreasing pressure.)" in the modification table on page 8/91.

11. **System response time**

- If system response time is critical, select a switch with a volumetric displacement that is compatible with the overall system. See the table below .

Volumetric displacement of 9012G pressure switches		
Class 9012 Type	Volumetric displacement (1) (in ³)	Volumetric displacement (1) (cm ³)
GAR, GAW, GDR, GDW-1& 21	0.20774	3.40422
GAR, GAW, GDR, GDW-2 & 22	0.07040	1.15385
GAR, GAW, GDR, GDW-4 & 24	0.04320	0.70805
GAR, GAW, GDR, GDW-5 & 25	0.02144	0.35140
GAR, GAW, GDR, GDW-6 & 26	0.01376	0.22553
GBR, GBW, GER, GEW-1 & 21	0.00200	0.13112
GBR, GBW, GER, GEW-2 & 22	0.00512	0.08392
GCR, GCW, GFR, GFW-1 & 21	0.00320	0.05245
GCR, GCW, GFR, GFW-2 & 22	0.00117	0.01922
GCR, GCW, GFR, GFW-3 & 23	0.00060	0.00924
GCR, GCW, GFR, GFW-4 & 24	0.00037	0.00612

(1) Figures shown are total displacement. When the switch is operated between settings only, displacement is 1/3 of the values shown.

Terminology

Measuring range

The measuring range (MR) of a pressure sensor corresponds to the difference between the upper and lower values measured by the load cell. It ranges between 0 and the pressure corresponding to the size of the sensor.

Operating range

The operating range of a pressure transmitter corresponds to its measuring range. Within this range, its analog output signal varies between 4 and 20 mA or 0 and 10 V, and is proportional to the measured pressure.

The operating range of a pressure or vacuum switch is the difference between the values of the minimum low setpoint (PB) and the maximum high setpoint (PH).

Precision

This includes linearity, hysteresis, repeat accuracy, and setting tolerances. It is expressed as a percentage of the measuring range of the load cell (%MR).

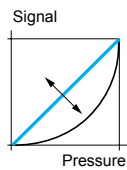

The linearity is the maximum deviation between the real transmitted curve and the ideal curve.

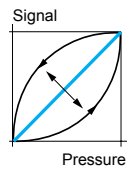

The hysteresis is the maximum deviation between the rising pressure curve and the falling pressure curve.

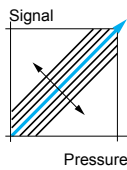

The repeat accuracy is the maximum drift encountered at varying pressures under given conditions.

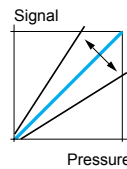
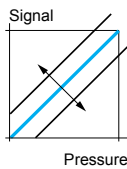

The setting tolerances are the manufacturer's tolerances with regard to the zero point and sensitivity (gradient of output signal curve from pressure transmitter).

Temperature drift

The precision of a pressure sensor is susceptible to variation due to the operating temperature.

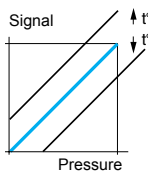

Zero point drift, proportional to the temperature, is expressed as %MR/°C.

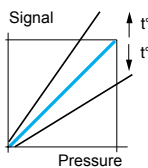

Sensitivity drift, proportional to the temperature, is expressed as %MR/°C.

Terminology (continued)

Switching point on rising pressure (PH)

This is the upper pressure setting at which the output of the electronic pressure or vacuum switch changes state on rising pressure.

Switching point on falling pressure (PB)

This is the lower pressure setting at which the output of the electronic pressure or vacuum switch changes state on falling pressure.

Differential

This is the difference between the switching point on rising pressure (PH) and the switching point on falling pressure (PB). The low point can be set at the values indicated on the operating curves shown on the product pages.

Switches with fixed differential

Depending on the switch, either the high or low operating point is adjustable, and the other operating point follows. The window is fixed.

Switches with adjustable differential

An adjustable differential allows independent setting of both operating points.

Spread

For dual-stage switches, the spread indicates the difference between the two operating points on rising pressure (PH2 and PH1) and, for vacuum switches, the difference between the two operating points on falling pressure (PB2 and PB1).

Differential-pressure sensing

Switches for differential-pressure sensing measure the difference between two pressures.

Size

Pressure transmitters and pressure switches

This is the maximum value of the operating range.

Vacuum transmitters and vacuum switches

This is the minimum value of the operating range.

Accuracy (switches with setting scale)

The tolerance between the point at which the switch actuates its contacts and the value indicated on the setting scale. Where very high setting accuracy is required (initial installation of the product), it is recommended that you use separate measuring equipment (pressure gauge, etc.).

Repeat accuracy

This is the variation in the operating point between several successive operations, or the tolerance between two consecutive switching operations.

Drift (F)

The tolerance of the operating point throughout the entire service life of the switch.

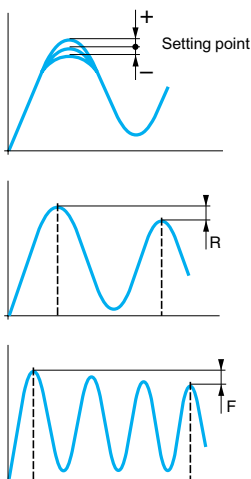

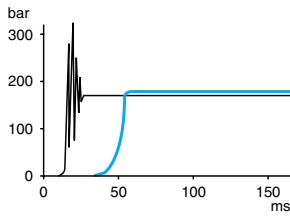

Example 1: With destructive (burst) pressure level

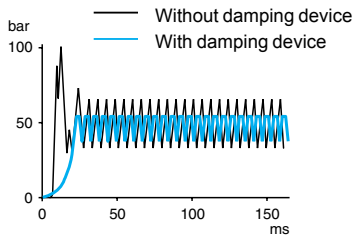

Example 2: With destructive (burst) pressure level and destructive pressure oscillations

Terminology (continued)

Maximum allowable pressure

The maximum value of an accidental pressure surge of very short duration (a few milliseconds).

Maximum permissible accidental pressure

This is the maximum pressure (excluding pressure surges) that the sensor can occasionally withstand without permanent damage.

Maximum allowable pressure per cycle (Ps)

The maximum pressure level per cycle that the switch can withstand for optimum service life.

Surge

A surge is a high rate of rise in pressure, normally of short duration, caused by starting a pump or by opening and closing a valve. Depending on frequency and duration, surge can reduce service life. Extremely high rates of rise in pressure can be damaging even if they are within the limits of the maximum allowable pressure.

Destruction pressure

Also called *burst pressure*, the destruction pressure is the pressure value which, if exceeded, is likely to cause serious damage to the sensor—such as leaking, bursting, or permanent damage.

Load resistance of pressure transmitters

The supply voltage and load resistance of a pressure transmitter must be selected according to the following formula:

$$R_{\text{load}} = \frac{U_{\text{supply}} - U_{\text{supply min.}}}{0.02 \text{ A}} \quad (U_{\text{supply min}} = 11 \text{ V for XMLE and } 17 \text{ V for XMLF})$$

OsiSense XML

Electromechanical pressure and vacuum switches

Introduction

XML pressure and vacuum switches for control circuits are used to control the pressure of hydraulic oils, fresh water, sea water, air, steam, corrosive fluids, or viscous products, up to 7250 psi (500 bar).

- **XMLA** pressure and vacuum switches have a fixed differential and are for detection of a single threshold. They incorporate a 1 C/O single-pole contact.
- **XMLB** pressure and vacuum switches have an adjustable differential and are for regulation between two thresholds. They incorporate a 1 C/O single-pole contact.
- **XMLC** pressure and vacuum switches have an adjustable differential and are for regulation between two thresholds. They incorporate two C/O single-pole contacts.
- **XMLD** pressure and vacuum switches are dual-stage switches, each stage with a fixed differential, and are for detection at each threshold. They incorporate two C/O single-pole contacts (one per stage).

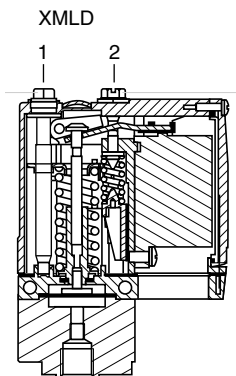
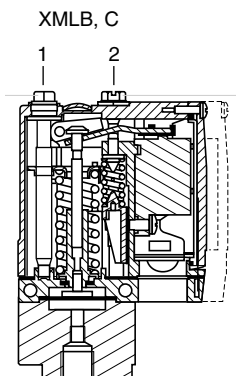
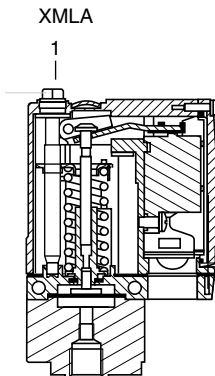

Setting

XMLA: Pressure and vacuum switches with fixed differential

- **Rising pressure**—Operating point PH is set by adjusting the red screw (1).
- **Falling pressure**—Operating point PB is not adjustable.

The difference between the trip and reset points of the contact is the inherent differential of the switch (contact differential, friction, etc.).

XMLB and XMLC: Pressure and vacuum switches with adjustable differential

When setting the pressure and vacuum switches, first adjust the operating point on rising pressure (PH), then the operating point on falling pressure (PB).

- **Rising pressure**—Operating point PH is set by adjusting the red screw (1).
- **Falling pressure**—Operating point PB is set by adjusting the green screw (2).

XMLD: Dual-stage pressure and vacuum switches with fixed differential for each threshold

Operating point on rising pressure of stage 1 and stage 2

- **First stage** operating point on rising pressure (PH1) is set by adjusting the red screw (1).
- **Second stage** operating point on rising pressure (PH2) is set by adjusting the blue screw (2).

Operating point on falling pressure

The operating points on falling pressure (PB1 and PB2) are not adjustable.

The difference between the trip and reset points of each contact is the inherent differential of the switch (such as contact differential or friction).

OsiSense XML

Electromechanical pressure and vacuum switches

Specifications	
Environmental specifications	
Conformity to standards	CE, IEC/EN 60947-5-1, UL 508, CSA C22-2 n° 14
Product certifications	UL, CSA, CCC, BV, LROS, RINA, GL, DNV, VIT-SEPRO
Protective treatment	Standard version TC. Special version TH
Ambient air temperature, °F (°C)	For operation: -13 to +158 (-25 to +70). Storage: -40 to +158 (-40 to +70)
Fluids or products controlled	Hydraulic oils, air, fresh water, sea water, 32–320 °F (0 to 160 °C), depending on model Steam, corrosive fluids, viscous products, 32–320 °F (0 to 160 °C), depending on model
Materials	Case: zinc alloy. Component materials in contact with fluid: see page 77
Operating position	All positions
Vibration resistance	4 gn (30–500 Hz) conforming to IEC 68-2-6 except XML•L35••••, XML•001••••• and XMLBM03•••••: 2 gn
Shock resistance	50 gn conforming to IEC 68-2-27 except XML•L35•••••, XML•001••••• and XMLBM03•••••: 30 gn
Electric shock protection	Class I conforming to IEC 1140, IEC 536 and NF C 20-030
Degree of protection	Screw terminal models: IP66 conforming to IEC/EN 60529 Connector models: IP65 conforming to IEC/EN 60529
Operating rate (operating cycles/minute)	Piston version switches: up to 60 cycles/minute for temperatures greater than 32 °F (0 °C) Diaphragm version switches: up to 120 cycles/minute for temperatures greater than 32 °F (0 °C),
Repeat accuracy	< 2%
Pressure connection ⁽¹⁾	<ul style="list-style-type: none"> G 1/4 (BSP female) conforming to NF E 03-005, ISO 228 1/4"-18 NPTF female PT 1/4 (JIS B0203).
Electrical connection ⁽¹⁾ for screw terminal models	<ul style="list-style-type: none"> 1/2" NPT electrical connections ISO M20 x 1.5 tapped entry DIN Pg 13.5 (n° 13) tapped entry Connector models, either M12 or DIN 43650 A: consult the Customer Care Center.

⁽¹⁾ See page 21, "Interpretation of the Catalog Number for XML Devices," for more information on specifying the electrical and pressure connections.

Contact block specifications																					
Rated operational specifications	~ AC-15; B300 (Ue = 240 V, Ie = 1.5 A - Ue = 120 V, Ie = 3 A) ∴ DC-13; R300 (Ue = 250 V, Ie = 0.1 A) conforming to IEC 947-5-1 Appendix A, EN 60 947-5-1																				
Rated insulation voltage	Ui = 500 V conforming to IEC/EN 60947-1 Ui = 300 V conforming to UL 508, CSA C22-2 n° 14																				
Rated impulse withstand voltage	Uimp = 6 kV conforming to IEC/EN 60947-1																				
Type of contacts Silver tipped contacts	XMLA and XMLB: 1 C/O single-pole contact (4 terminal), snap action XMLC: 2 C/O single-pole contacts (8 terminal), simultaneous, snap action XMLD: 2 C/O single-pole contacts (8 terminal), staggered, snap action																				
Resistance across terminals (mΩ)	< 25 conforming to NF C 93-050 method A or IEC 255-7 category 3																				
Terminal referencing	Conforming to CENELEC EN 50013																				
Short-circuit protection	10 A cartridge fuse type gG (gl)																				
Connection	Screw clamp terminals. Clamping capacity, min: 1 x 0.2 mm ² , max: 2 x 2.5 mm ²																				
Electrical durability Conforming to IEC/EN 60947-5-1 Appendix C Utilization categories AC-15 and DC-13	<table border="0"> <tr> <td>XMLA and XMLB AC supply ~ 50/60 Hz ∴ Inductive circuit, Ithe = 10 A</td> <td>XMLC and XMLD AC supply ~ 50/60 Hz ∴ Inductive circuit, Ithe = 10 A</td> </tr> </table>	XMLA and XMLB AC supply ~ 50/60 Hz ∴ Inductive circuit, Ithe = 10 A	XMLC and XMLD AC supply ~ 50/60 Hz ∴ Inductive circuit, Ithe = 10 A																		
XMLA and XMLB AC supply ~ 50/60 Hz ∴ Inductive circuit, Ithe = 10 A	XMLC and XMLD AC supply ~ 50/60 Hz ∴ Inductive circuit, Ithe = 10 A																				
Operating rate: 3600 operating cycles/hour Load factor: 0.5																					
	DC supply ∴ Power broken in W for 1 million operating cycles	DC supply ∴ Power broken in W for 5 million operating cycles																			
	<table border="1"> <thead> <tr> <th>Voltage</th> <th>V</th> <th>24</th> <th>48</th> <th>120</th> </tr> </thead> <tbody> <tr> <td>∴</td> <td>W</td> <td>31</td> <td>29</td> <td>26</td> </tr> </tbody> </table>	Voltage	V	24	48	120	∴	W	31	29	26	<table border="1"> <thead> <tr> <th>Voltage</th> <th>V</th> <th>24</th> <th>48</th> <th>120</th> </tr> </thead> <tbody> <tr> <td>∴</td> <td>W</td> <td>10</td> <td>7</td> <td>4</td> </tr> </tbody> </table>	Voltage	V	24	48	120	∴	W	10	7
Voltage	V	24	48	120																	
∴	W	31	29	26																	
Voltage	V	24	48	120																	
∴	W	10	7	4																	

OsiSense XML

Electromechanical pressure and vacuum switches

Function

Pressure and vacuum switches control or regulate pressure or vacuum levels in hydraulic or pneumatic systems. They transform the pressure change into a digital electrical signal when the preset operating points are reached.

Switches for control circuits

Switches with control-duty rated electrical contacts, designed for control of contactors, relays, power valves, PLC inputs, etc.

Switches for power circuits

Switches with power electrical contacts (1, 2, or 3 pole) designed for direct switching of single-phase or three-phase motors (pumps, compressors, etc.).

Pressure switch operating principle

Fixed Differential: Detection of a Single Threshold

Fixed differential switches have a single adjustable setting point (either PH or PB). The differential between the high and low points (PH-PB) depends on the construction of the switch. It is not adjustable.

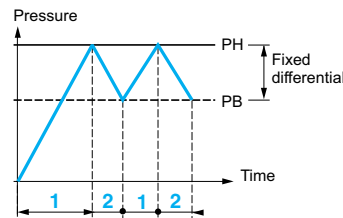

— Adjustable value
 --- Nonadjustable value

PH = High point (on rising pressure)
 PB = Low point (on falling pressure)

Example: Contact schematics of XMLA

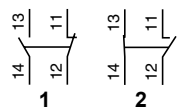

Adjustable Differential: Regulation between Two Thresholds

Adjustable differential switches have setting points for both the high point (PH) and the low point (PB). Both of these points can be independently adjusted.

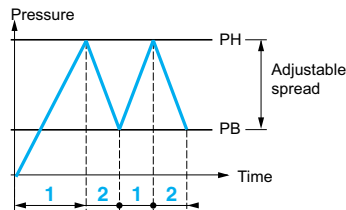

— Adjustable value

PH = High point (on rising pressure)
 PB = Low point (on falling pressure)

Example: Contact schematics of XMLB

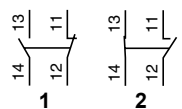

Dual-Stage: Detection of Two Thresholds

Dual-stage switches allow two distinct levels of control to be monitored with one device. Each stage allows detection of a single threshold with a single setting point (fixed differential). Both these points can be independently adjusted. However, for both stages, the differential between the high point and the low point (PH1-PB1 and PH2-PB2) is fixed and depends on the construction of the switch.

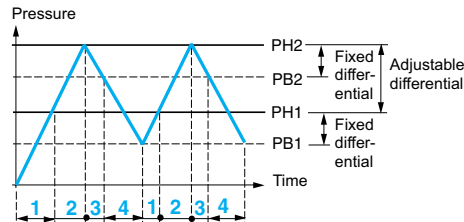

— Adjustable value
 --- Nonadjustable value

PH = High point (on rising pressure)
 PB = Low point (on falling pressure)

Example: Contact schematics of XMLD

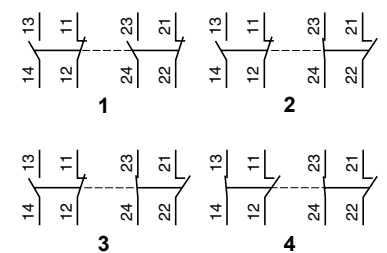

Fixed differential

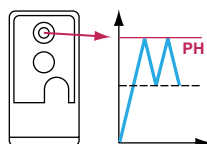

Adjustable differential

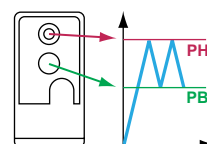

OsiSense XML

Electromechanical pressure and vacuum switches

Vacuum switch operating principle

Detection of a single threshold

The switches for detection of a single threshold (fixed differential) have a single adjustable setting point (PH). The differential between the high and low points (PH–PB) depends on the inherent characteristics of the switch. It is not adjustable.

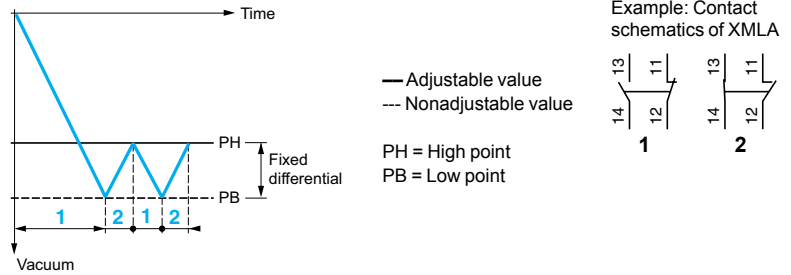

Regulation between two thresholds

The switches for regulation between two thresholds (adjustable differential) have both a high point setting (PH) and a low point setting (PB). Both of these points can be independently adjusted.

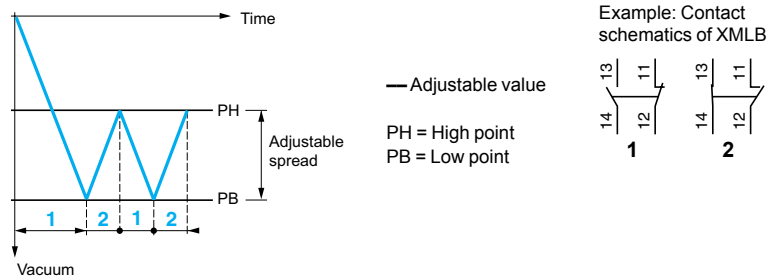

Detection of two thresholds

The dual-stage switches, for detection at each threshold, have an adjustable high point setting for each stage (PH1 and PH2). Both of these points can be independently adjusted.

For both stages, the differential between the high point and the low point (PH1–PB1 and PH2–PB2) depends on the inherent characteristics of the switch. It is not adjustable.

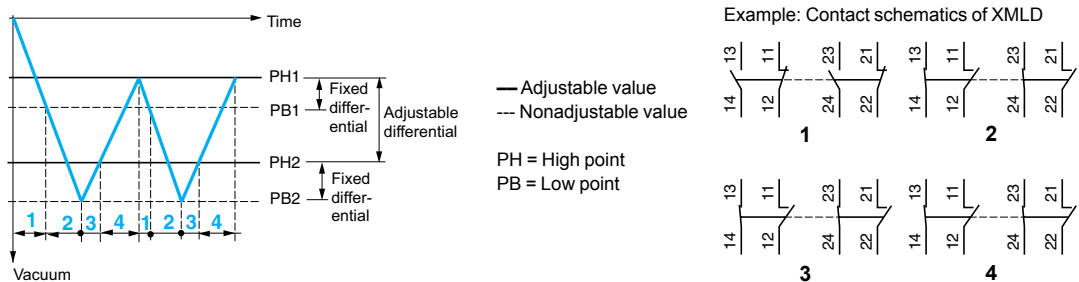

Maximum allowable accidental pressure

The maximum accidental pressure of XML switches is equal to at least 2.25 times the switch size.

If accidental overpressures occur and their duration is less than 50 milliseconds, the pressure damping device incorporated in the XML switches (sizes 10 bar and greater) reduces the effect.

OsiSense XML

Electromechanical pressure and vacuum switches

Application range of pressure and vacuum switches types XML, XMA and XMX, for control circuits

On standard loads: Continuous duty, frequent switching.

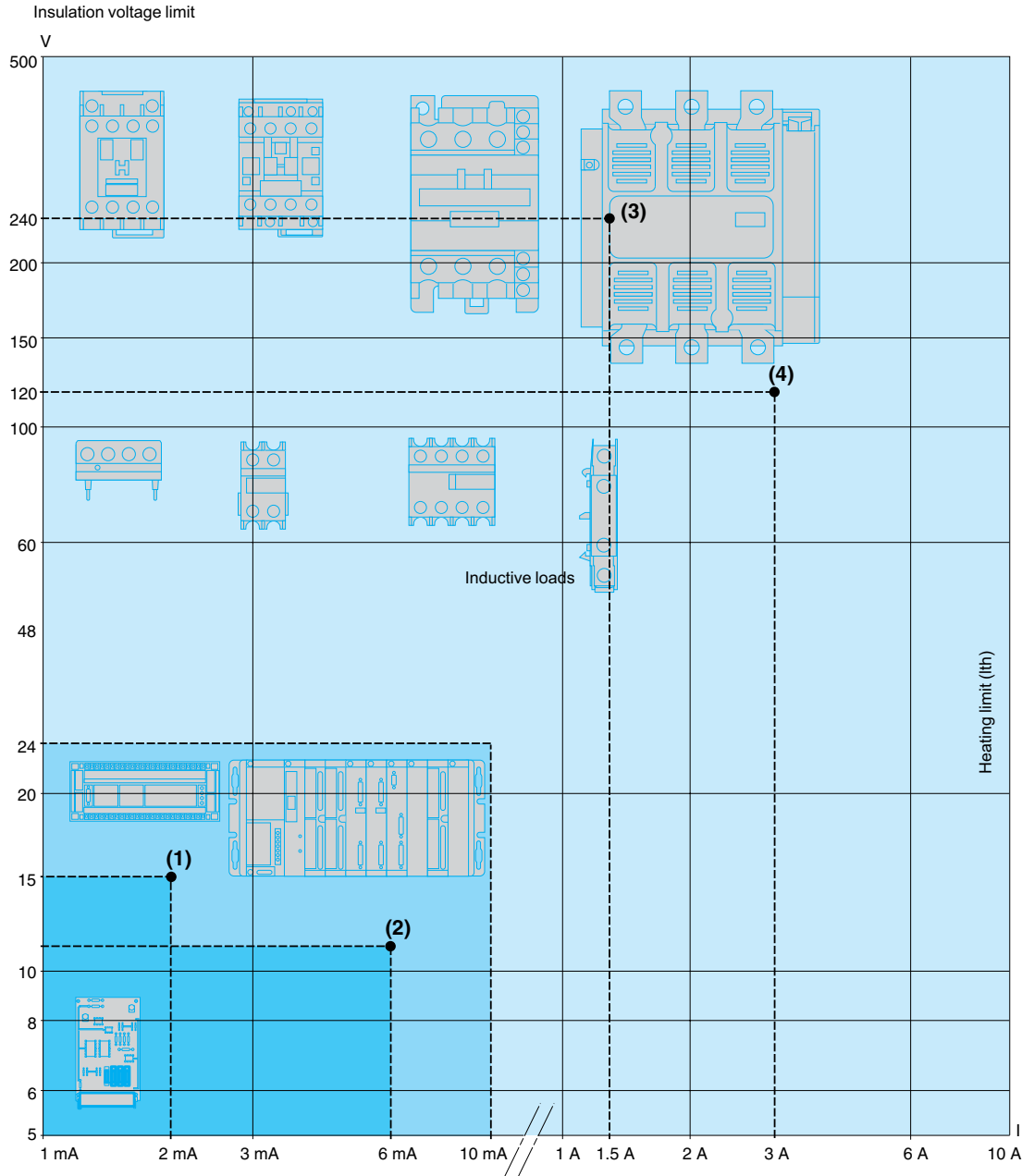

(1) Standard PLC input, type 1

(2) Standard PLC input, type 2

(3) Switching capacity conforming to IEC 947-5-1, utilization category AC-15, DC-13

B300	240 V	1.5 A
R300	250 V	0.1 A

(4) Switching capacity conforming to IEC 947-5-1, utilization category AC-15, DC-13

B300	120 V	3 A
R300	125 V	0.22 A

PLC: programmable logic controller

Pressure switches	Application range	
XMLA, XMLB, XMLC, XMLD		
XMLE, XMLF, XMLG		

On small loads: The use of electromechanical pressure and vacuum switches with programmable logic controllers is becoming more prevalent. On small loads, the switches maintain a failure rate of less than 1 for 100 million operating cycles. Results may vary depending on application.

OsiSense XML

Electromechanical pressure and vacuum switches

Selecting the switch size

After establishing the type of switch required for the application (single threshold detection or regulation between two thresholds), the selection of its size depends on the following criteria:

- the differential: difference between the high point (PH) and the low point (PB),
- the maximum pressure allowable per cycle,
- repeat accuracy, precision and minimum drift.

Selecting a fixed differential pressure switch for detecting a single threshold

Main criterion: minimum differential

Example: for a selected high point (PH) of 7 bar

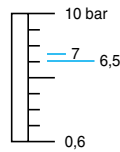

XMLA010.....
Differential = 0.5 bar

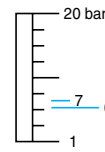

XMLA020.....
Differential = 1 bar

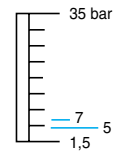

XMLA035.....
Differential = 2 bar

Select an XMLA010..... (the lowest size)

Main criterion: tolerance to overpressures

Example: for a selected high point (PH) of 12 bar

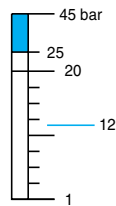

XMLA020.....
Allowable accidental overpressure = 45 bar

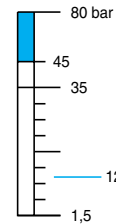

XMLA035.....
Allowable accidental overpressure = 80 bar

Select an XMLA035..... (the highest size)

Main criterion: repeat accuracy, precision and minimum drift

Example: for a selected high point (PH) of 18 bar

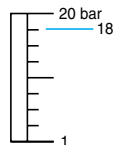

XMLA020.....
Adjustable from 1–20 bar

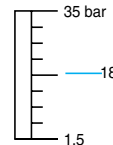

XMLA035.....
Adjustable from 1.5–35 bar

As a general rule, avoid working at the upper or lower limits of the operating range.

Select an XMLA035.....

Converting Units of Pressure

	psi	kg/cm ²	bar	atm	mm Hg (Torr)	mm H ₂ O	Pa
1 psi =	1	0.07031	0.06895	0.06805	51.71	703.7	6895
1 kg/cm ² =	14.22	1	0.98066	0.96784	735.55	10 000	98 066
1 bar =	14.50	1.0197	1	0.98695	750.06	10 197	10 ⁵
1 atm =	14.70	1.0333	1.0132	1	760.0	10 333	101 325
1 mm Hg = (Torr)	0.01934	1.360 x 10 ⁻³	1.333 x 10 ⁻³	1.316 x 10 ⁻³	1	13.59	133.3
1 mm H ₂ O =	1.421 x 10 ⁻³	10 ⁻⁴	~ 10 ⁻⁴	~ 10 ⁻⁴	0.07361	1	~ 9.80
1 Pa =	1.45 x 10 ⁻⁴	1.0197 x 10 ⁻⁵	10 ⁻⁵	9.8695 x 10 ⁻⁶	7.5 x 10 ⁻³	0.10197	1

Example: 1 bar = 14.50 psi = 10⁵ Pa

Operating curves: Fixed Differential, Detecting a Single Threshold

Adjustment range of the high point

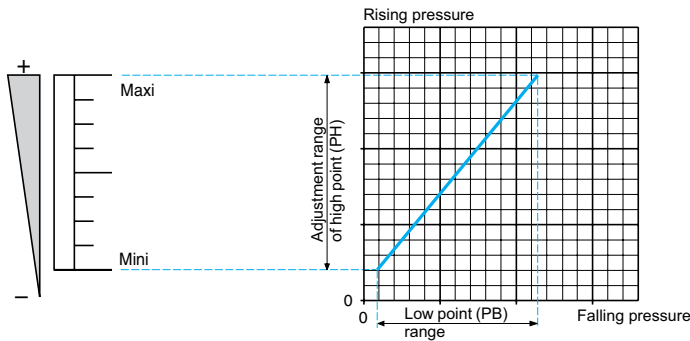

Defined by the difference between the minimum and maximum high point (PH) setting values.

For a high set point (PH), the lower point (PB) is fixed and cannot be adjusted.

For a low set point (PB), the higher point (PH) is fixed and cannot be adjusted.

Operating point on rising pressure (PH)

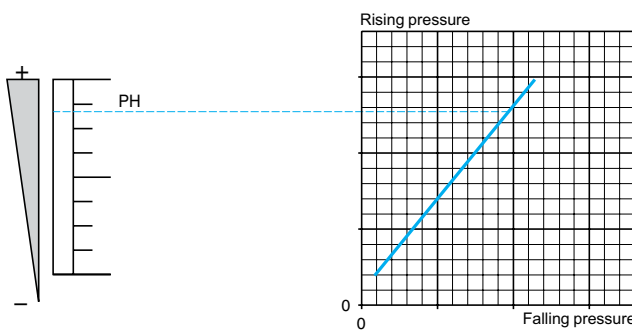

The upper pressure setting at which the pressure or vacuum switch actuates the contacts on rising pressure.

Adjustable throughout the range on rising pressure.

Operating point on falling pressure (PB)

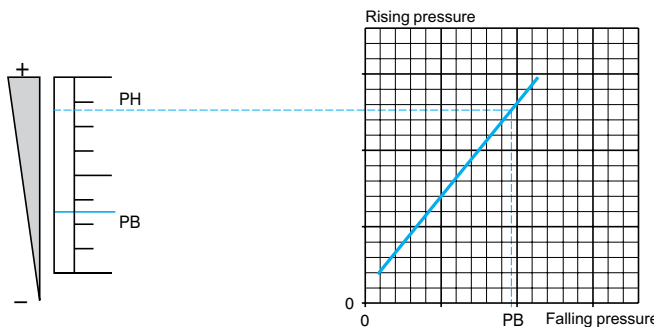

The pressure at which the switch contact changes state on falling pressure.

The lower point (PB) is not adjustable and is entirely dependent on the high point setting (PH) and the inherent differential of the switch.

Differential

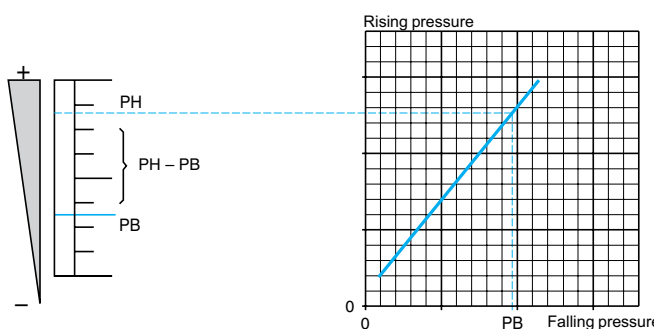

$PH - PB =$ inherent differential

The difference between the operating point on rising pressure (PH) and the operating point on falling pressure (PB).

This point is not adjustable, so the value of the differential is fixed.

It is the inherent differential of the switch (contact differential, friction, etc.).

Example

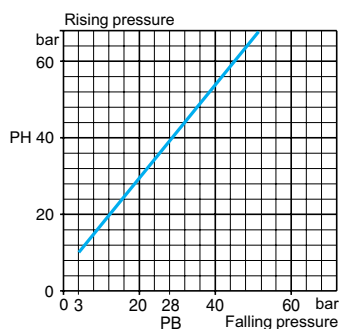

Operating point on rising pressure (PH) is 40 bar (set value at which the contact changes state on rising pressure).

The operating point on falling pressure (PB) is 28 bar (fixed value at which the contact returns to its original state).

Conclusion:
the differential is $40 - 28 = 12$ bar.

Operating curves: Adjustable Differential, Regulating between Two Thresholds

Adjustment range of the high point

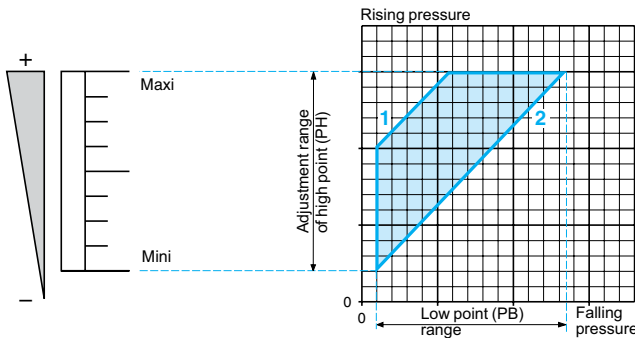

Defined by the difference between the minimum and maximum high point (PH) setting values.

Operating point on rising pressure (PH)

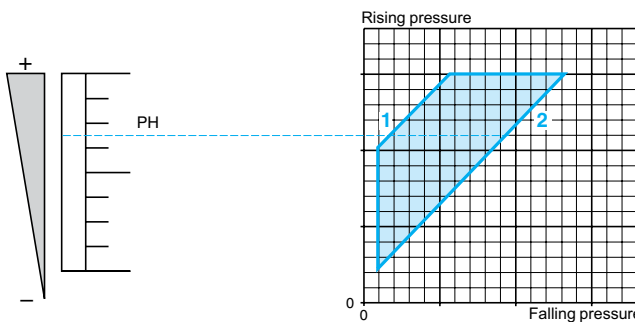

The upper pressure setting at which the pressure or vacuum switch actuates the contacts on rising pressure. Adjustable throughout the range on rising pressure.

Operating point on falling pressure (PB)

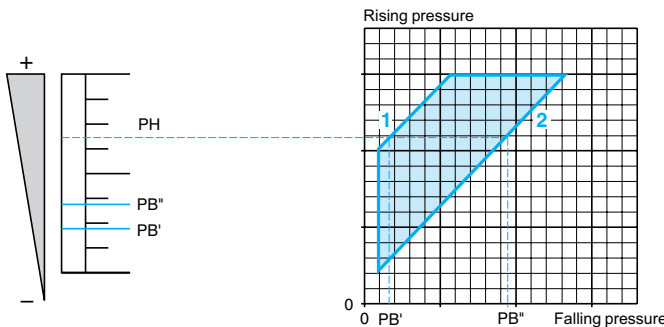

The pressure at which the switch contact changes state on falling pressure. The adjustable differential enables the independent setting of the lower point (PB).

Differential

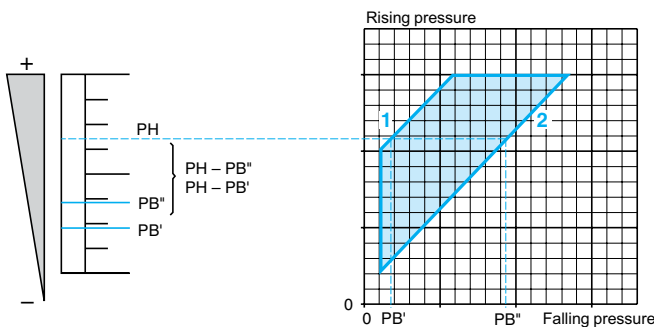

Low point < High point

$PH - PB'$ = inherent differential
 $PH - PB''$ = minimum differential

The difference between the operating point on rising pressure (PH) and the operating point on falling pressure (PB).

Note: the low point can be set at any value between PB' and PB'' .

Example

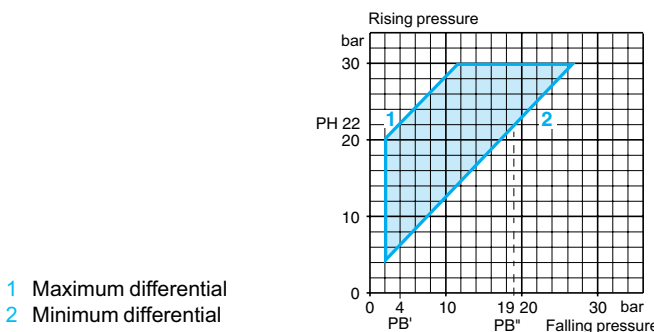

Operating point on rising pressure (PH) is 22 bar (set value at which the contact changes state on rising pressure).

The operating point on falling pressure (PB) ranges from 4 and 19 bar (set value at which the contact returns to its original state).

Conclusion:
 the maximum differential is $22 - 4 = 18$ bar,
 the minimum differential is $22 - 19 = 3$ bar.

Operating curves: Dual-Stage, Fixed Differential, Detection at Each Threshold (switching on rising pressure)

Adjustment ranges of the operating points PH1 and PH2 on rising pressure

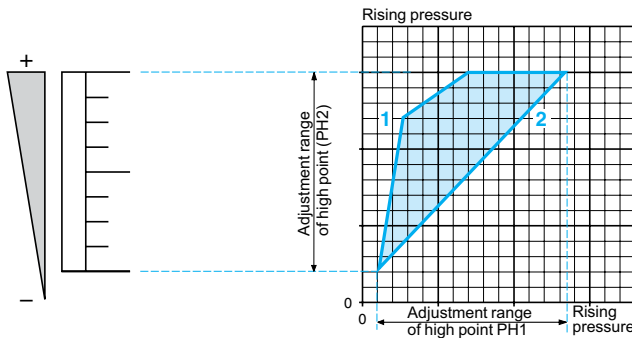

Defined by the difference between the minimum and maximum high point setting values of each stage (PH1 and PH2).

Operating point PH2 on rising pressure

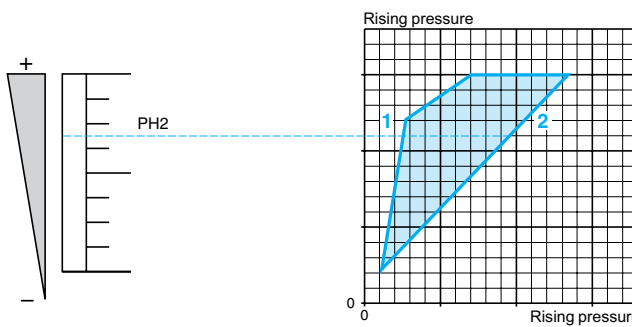

The upper pressure setting at which the pressure or vacuum switch actuates contact 2 on rising pressure. Adjustable throughout the range on rising pressure.

Operating point PH1 on rising pressure

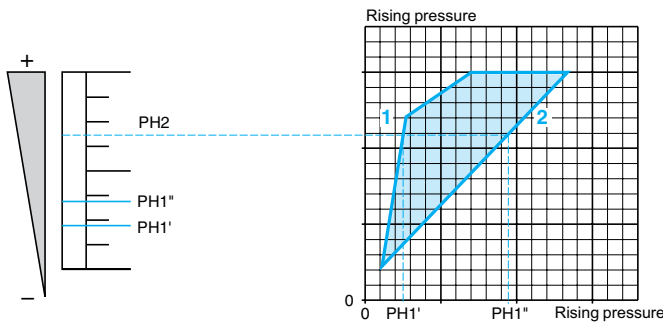

The upper pressure setting at which the pressure or vacuum switch actuates contact 1 on rising pressure.

Spread

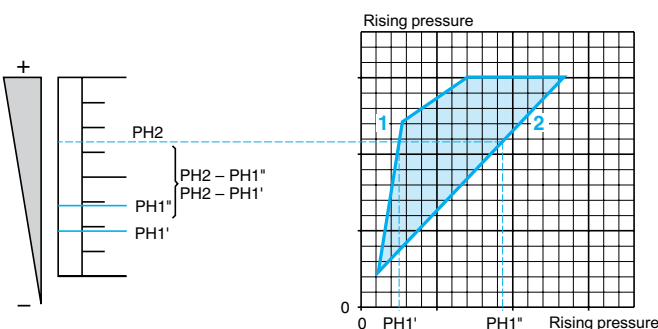

$PH1 < PH2$
 $PH2 - PH1' = \text{maximum spread}$
 $PH2 - PH1'' = \text{minimum spread}$

The difference between operating points PH2 and PH1 on rising pressure.

Note: operating point PH1 can be set at any value between PH1' and PH1''.

Example: Determining operating points on rising pressure for the two stages

- 1 Maximum spread
- 2 Minimum spread

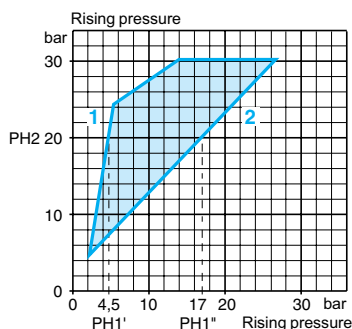

Second stage operating point on rising pressure (PH2) = 20 bar (set value at which contact 2 changes state on rising pressure). First stage operating point (PH1) can be set between 4.5 and 17 bar on rising pressure.

Conclusion:
 the maximum spread is:
 $20 - 4.5 = 15.5 \text{ bar}$,
 the minimum spread is:
 $20 - 17 = 3 \text{ bar}$.

OsiSense XML

Electromechanical pressure and vacuum switches

Operating curves: Dual-Stage, Fixed Differential, Detection at Each Threshold (switching on rising pressure)

Adjustment range of high point (PH1 or PH2)

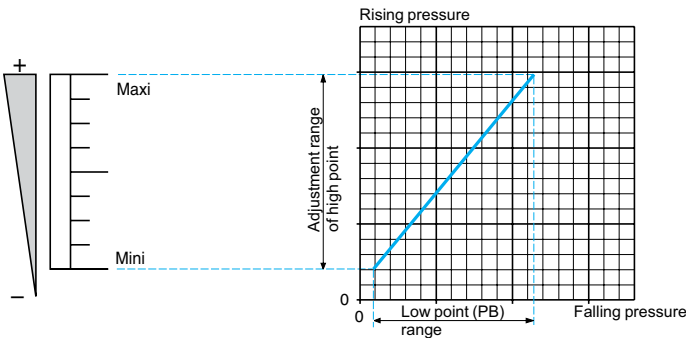

Defined by the difference between the minimum and maximum high point (PH1 or PH2) setting values for each stage.

For a high set point (PH1 or PH2), the lower point (PB1 or PB2) is fixed and cannot be adjusted.

For a low set point (PB1 or PB2), the higher point (PH1 or PH2) is fixed and cannot be adjusted.

Operating point on rising pressure (PH1 or PH2)

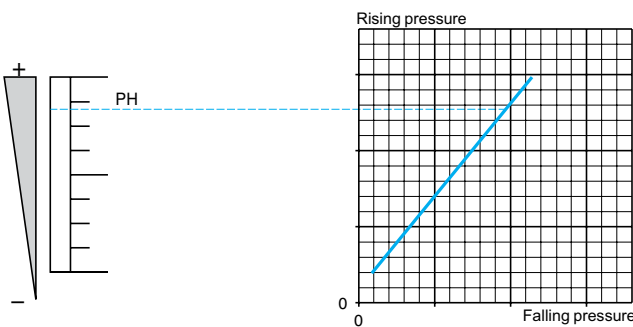

The upper pressure setting at which the pressure or vacuum switch actuates the contact, for each stage, on rising pressure. Adjustable throughout the range on rising pressure.

Operating point on falling pressure (PB1 or PB2)

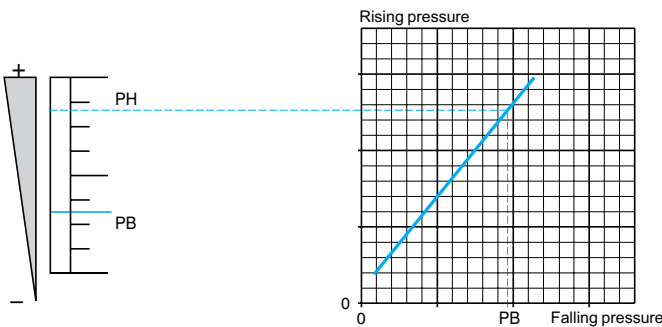

The pressure at which the switch contact changes state, for each stage, on falling pressure.

The lower point (PB) is not adjustable and is entirely dependent on the high point setting (PH) and the inherent differential of the switch.

Differential

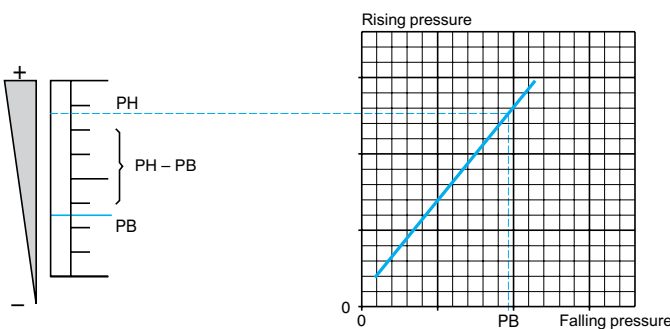

$PH - PB =$ inherent differential

The difference between the operating point on rising pressure (PH) and the operating point on falling pressure (PB), for each stage. This point is not adjustable, so the value of the differential is fixed. It is the inherent differential of the switch (contact differential, friction, etc.) for each of its two stages.

Example:
 stage 1 = segment EF
 stage 2 = segment GH

- 1 Maximum spread
- 2 Minimum spread

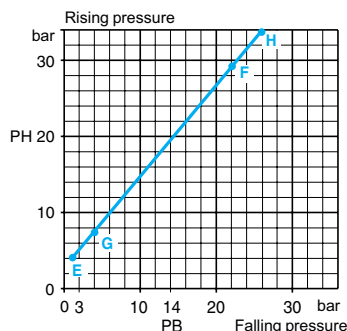

For stage 2 (segment GH):

Operating point on rising pressure (PH2) is 20 bar (set value at which contact 2 changes state on rising pressure). The operating point on falling pressure (PB2) is 14 bar (fixed value at which contact 2 returns to its original state).

Conclusion: for stage 2, the differential is: $20 - 14 = 6$ bar.

Repeat the same procedure for stage 1 (segment EF).

Interpreting the Catalog Number for XML Devices

Example: XMLA004A2S13		XML	A	004	A	2	S	1	3
Designation		Catalog number							
XML Pressure Switch		XML							
Type	Nonadjustable differential, single pole	A							
	Adjustable differential, single pole	B							
	Adjustable differential, double pole	C							
	Nonadjustable differential, double pole	D							
Operating range bar (psi)	0 to 0.05 (0 to 0.725)		L05						
	0 to 0.35 (0 to 5.075)		L35						
	0 to 0.35 (0 to 5.075) Overpressure 0.30 (4.35)		S35						
	-1 to -0.28 (-14.5 to -4.06)		M01						
	-1 to -0.14 (-14.5 to -2.03)		M02						
	-0.2 to -0.02 (-2.9 to -0.029)		M03						
	-0.5 to 5 (-7.25 to 72.5)		M05						
	0 to 1 (0 to 14.5)		001						
	0 to 2.5 (0 to 36.25)		002						
	0 to 2.5 (0 to 36.25) Overpressure 0.30 (4.35)		S02						
	0 to 4 (0 to 58)		004						
	0 to 4 (0 to 58) Overpressure 0.30 (4.35)		S04						
	0 to 10 (0 to 145)		010						
	0 to 10 (0 to 145) Overpressure 0.30 (4.35)		S10						
	0 to 20 (0 to 290)		020						
	0 to 20 (0 to 290) Overpressure 0.30 (4.35)		S20						
	0 to 35 (0 to 507.5)		035						
	0 to 40 (0 to 580)		040						
	0 to 70 (0 to 1015)		070						
	0 to 160 (0 to 2320)		160						
0 to 300 (0 to 4350)		300							
0 to 500 (0 to 7250)		500							
Input fluid	Diaphragm type								
	Hydraulic oils, air, fresh, or sea water, 32–158 °F (0–70 °C)		A						
	Hydraulic oils, air, fresh, or sea water, 32–320 °F (0–160 °C)		B						
	Corrosive fluid		C						
	Viscous products		P						
	Hydraulic oils or air, 32–140 °F (0–60 °C)		R						
	Fresh or sea water, 32–320 °F (0–160 °C)		S						
	Vacuum type with diaphragm								
	Hydraulic oils, air, fresh or sea water, 32–158 °F (0–70 °C)		V						
	Hydraulic oils, air, fresh or sea water, 32–320 °F (0–160 °C)		T						
Piston type	Hydraulic oils or air, 32–320 °F (0–160 °C)		D						
	Fresh or sea water, 32–320 °F (0–160 °C)		E						
	Corrosive fluid, 32–320 °F (0–160 °C)		N						
	Not provided								
Display	Provided					1			
	Threaded hole					2			
Electrical connection	DIN 43650 connector						S		
	M12 threaded connector						C		
	M12 threaded connector (Micro Change type)						D		
Contact type	Dry contact							1	
Entry type	European								
	Pressure	G 1/4 (BSP female) G 1-1/4 for viscous products (input fluid identifier = P)							1
	Electrical	Type 13 (Pg 13.5)							
	Pressure	G 1/4 (BSP female) G 1-1/4 for viscous products (input fluid identifier = P)							2
	Electrical	ISO M20							
	U.S.A.								
	Pressure	1/4"-18 NPTF							3
	Electrical	1/2"-14 NPT							
	Japan								
	Pressure	PT 1/4 (JIS B0203)							4
Electrical	1/2 in. PF (JIS B0202)								
Options	May indicate factory setting								...

Size: -1 bar (-14.5 psi)
Fixed differential, for detection of a single threshold
1 C/O single-pole contact

XMLA vacuum switches **With setting scale**

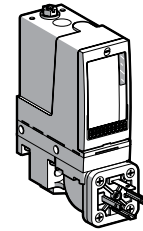
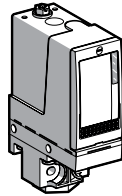

Adjustable range of operating point (PB) (falling pressure)	-0.28 to -1 bar (-4.06 to -14.5 psi)			
Catalog numbers				
Fluids controlled For materials in contact with fluid, see page 77.	Hydraulic oils, fresh water, sea water, air, up to 158 °F (70 °C)	XMLAM01V2S13	XMLAM01V2S11	XMLAM01V2C11
	Hydraulic oils, fresh water, sea water, air, corrosive fluids, up to 320 °F (160 °C)	XMLAM01T2S13	XMLAM01T2S11	XMLAM01T2C11
Pressure connection		1/4"-18 NPTF	G 1/4-19 BSP	G 1/4-19 BSP
	Conduit/cable entry	1/2" NPT	Pg 13.5	DIN 43650A, 4-pin male.
Electrical connection	Terminals	1 x 0.2 to 2 x 2.5 mm ² (1 x 24 to 2 x 14 AWG)		For suitable female connector, see page 73.
	Weight, lb (kg)	1.51 (0.685)		1.58 (0.715)
Supplementary specifications (not shown under general specifications)				
Inherent differential (add to PB to get PH)	At low setting	0.24 bar ±0.05 (3.48 psi ±0.72)		
	At high setting	0.24 bar ±0.05 (3.48 psi ±0.72)		
Maximum allowable pressure	Per cycle	5 bar (72.5 psi)		
	Accidental	9 bar (130.5 psi)		
Destruction pressure	18 bar (261 psi)			
Vacuum switch style	Diaphragm			

Operating curves **Connection**

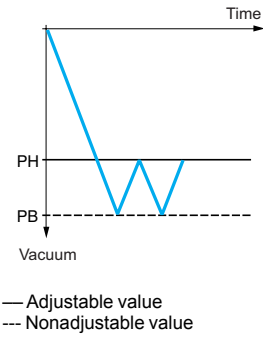
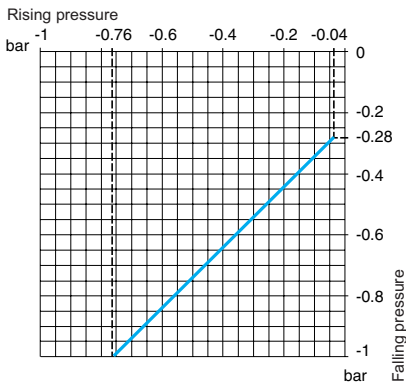

Terminal model



Connector model

Vacuum switch connector pin view

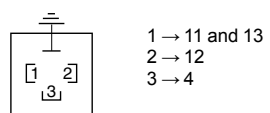

Other versions For switches with alternative tapped cable entries, consult the Customer Care Center.

Size: -1 bar (-14.5 psi)
Adjustable differential, for regulation between two thresholds
1 C/O single-pole contact

XMLB vacuum switches **With setting scale**



Adjustable range of operating point (PB) (falling pressure)	-0.14 to -1 bar (-2.03 to -14.5 psi)			
Catalog numbers				
Fluids controlled For materials in contact with fluid, see page 77.	Hydraulic oils, fresh water, sea water, air, up to 158 °F (70 °C)	XMLBM02V2S13	XMLBM02V2S11	XMLBM02V2C11
	Hydraulic oils, fresh water, sea water, air, corrosive fluids, up to 320 °F (160 °C)	XMLBM02T2S13	XMLBM02T2S11	XMLBM02T2C11
Pressure connection		1/4"-18 NPTF	G 1/4-19 BSP	G 1/4-19 BSP
	Conduit/cable entry	1/2" NPT	Pg 13.5	DIN 43650A, 4-pin male
Electrical connection	Terminals	1 x 0.2 to 2 x 2.5 mm ² (1 x 24 to 2 x 14 AWG)		For suitable female connector, see page 73.
	Weight, lb (kg)	2.24 (1.015)	2.24 (1.015)	2.27 (1.030)
Supplementary specifications (not shown under general specifications)				
Possible differential (add to PB to get PH)	Min. at low setting	0.13 bar ±0.02 (1.88 psi ±0.29)		
	Min. at high setting	0.13 bar ±0.02 (1.88 psi ±0.29)		
	Max. at high setting	0.8 bar (11.6 psi)		
Maximum allowable pressure	Per cycle	5 bar (72.5 psi)		
	Accidental	9 bar (130.5 psi)		
Destruction pressure	18 bar (261 psi)			
Vacuum switch style	Diaphragm			

Operating curves **Connection**

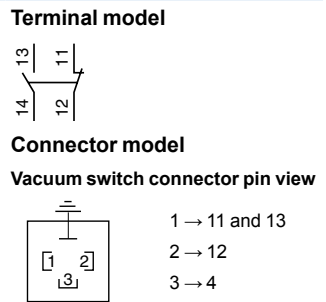
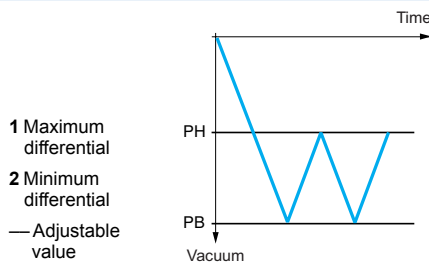
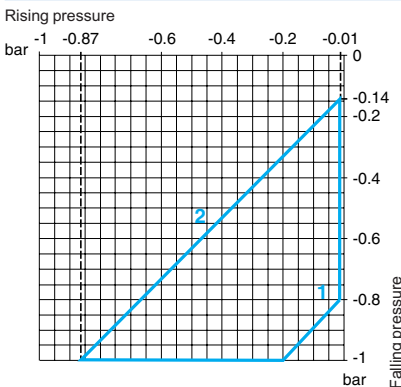

Other versions For switches with alternative tapped cable entries, consult the Customer Care Center.

Size: -1 bar (-14.5 psi)
Adjustable differential, for regulation between two thresholds
2 C/O single-pole contacts

XMLC vacuum switches **With setting scale**

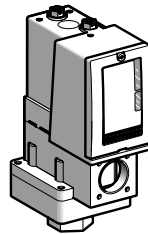

Adjustable range of operating point (PB)
 (falling pressure) -0.14 to -1 bar (-2.03 to -14.5 psi)

Catalog numbers

Fluids controlled For materials in contact with fluid, see page 77.	Hydraulic oils, fresh water, sea water, air, up to 158 °F (70 °C)	XMLCM02V2S13	XMLCM02V2S11
	Hydraulic oils, fresh water, sea water, air, corrosive fluids, up to 320 °F (160 °C)	XMLCM02T2S13	XMLCM02T2S11

Pressure connection 1/4"-18 NPTF G 1/4-19 BSP

Electrical connection
 Conduit/cable entry 1/2" NPT Pg 13.5
 Terminals 1 x 0.2 to 2 x 2.5 mm² (1 x 24 to 2 x 14 AWG)

Weight, lb (kg) 2.24 (1.015)

Supplementary specifications (not shown under general specifications)

Possible differential (add to PB to get PH)	Min. at low setting	0.13 bar ±0.02 (1.89 psi ±0.29)
	Min. at high setting	0.14 bar ±0.02 (2.03 psi ±0.29)
	Max. at high setting	0.8 bar (11.6 psi)
Maximum allowable pressure	Per cycle	5 bar (72.5 psi)
	Accidental	9 bar (130.5 psi)
Destruction pressure		18 bar (261 psi)

Vacuum switch style Diaphragm

Operating curves **Connection**

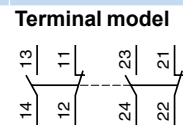
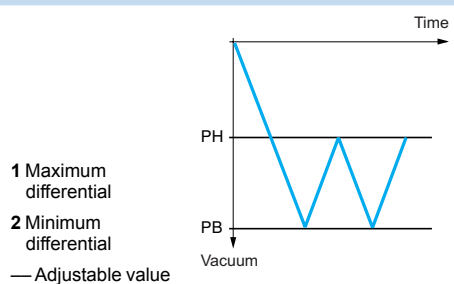
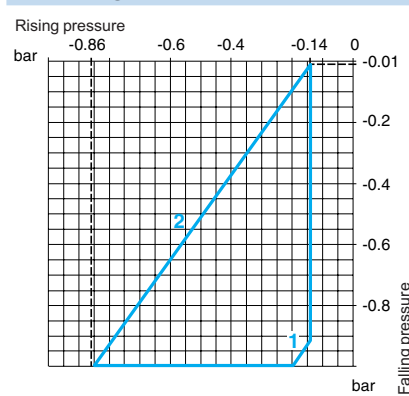

Other versions For switches with alternative tapped cable entries, consult the Customer Care Center.

Size: -1 bar (-14.5 psi)
Dual-stage, fixed differential, for detection at each threshold
2 C/O single-pole contacts (one per stage)

XMLD vacuum switches **Without setting scale**

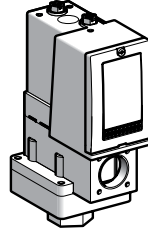

Adjustable range of operating points (falling pressure)	2nd stage operating point (PB2) 1st stage operating point (PB1)	-0.12 to -1 bar (-1.74 to -14.5 psi) -0.10 to -0.98 bar (-1.45 to -14.21 psi)
Spread between the two stages (PB2—PB1)		0.02 to 0.88 bar (0.29 to 12.76 psi)
Catalog numbers		
Fluids controlled For materials in contact with fluid, see page 77.	Hydraulic oils, fresh water, sea water, air, up to 158 °F (70 °C)	XMLDM02V1S13 XMLDM02V1S11
	Hydraulic oils, fresh water, sea water, air, corrosive fluids, up to 320 °F (160 °C)	XMLDM02T1S13 XMLDM02T1S11
Pressure connection		1/4"-18 NPTF G 1/4-19
Electrical connection	Conduit/cable entry	1/2" NPT Pg 13.5
	Terminals	1 x 0.2 to 2 x 2.5 mm ² (1 x 24 to 2 x 14 AWG)
Weight, lb (kg)		2.24 (1.015)
Supplementary specifications (not shown under general specifications)		
Inherent differential (add to PB1/PB2 to get PH1/PH2)	At low setting	0.1 bar ±0.035 (1.45 psi ±0.51)
	At high setting	0.1 bar ±0.02 (1.45 psi ±0.29)
Maximum allowable pressure	Per cycle	5 bar (72.5 psi)
	Accidental	9 bar (130.5 psi)
Destruction pressure		18 bar (261 psi)
Vacuum switch style		Diaphragm

Operating curves

High setting trip points of contacts 1 and 2

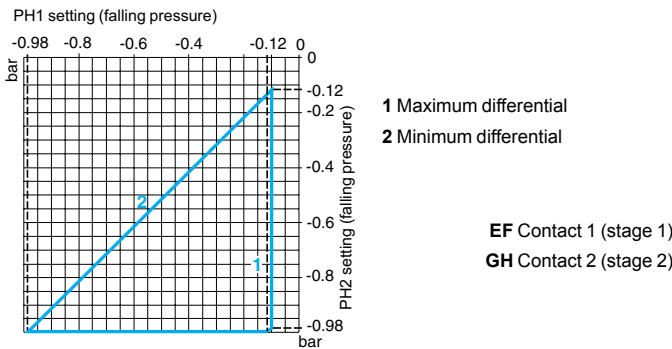

Inherent differential of contacts 1 and 2

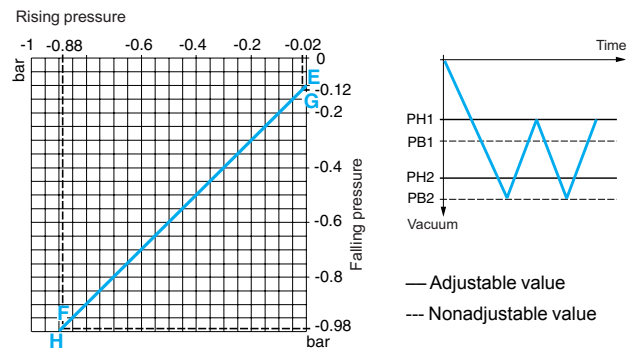

Connection: Terminal model

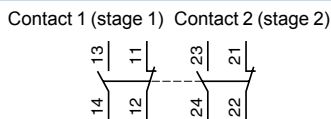

Other versions For switches with alternative tapped cable entries, consult the Customer Care Center.

Size: -200 mbar (-2.9 psi)
Adjustable differential, for regulation between two thresholds
1 C/O single-pole contact

XMLB vacuum switches **With setting scale**

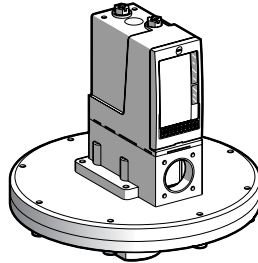

Adjustable range of operating point (PB)
 (falling pressure) -20 to -200 mbar (-0.29 to -2.9 psi)

Catalog numbers

Fluids controlled For materials in contact with fluid, see page 77.	Hydraulic oils, air, up to 320 °F (160 °C)	XMLBM03R2S13	XMLBM03R2S11
	Fresh water, sea water, corrosive fluids, up to 320 °F (160 °C)	XMLBM03S2S13	XMLBM03S2S11
Pressure connection		1/4"-18 NPTF	G 1/4-19
Electrical connection	Conduit/cable entry	1/2" NPT	Pg 13.5
	Terminals	1 x 0.2 to 2 x 2.5 mm ² (1 x 24 to 2 x 14 AWG)	
Weight, lb (kg)	7.30 (3.310)		

Supplementary specifications (not shown under general specifications)

Possible differential (add to PB to get PH)	Min. at low setting	18 mbar ±2 (0.26 psi ±0.29)
	Min. at high setting	18 mbar ±2 (0.26 psi ±0.29)
	Max. at high setting	180 mbar (2.6 psi)
Maximum allowable pressure	Per cycle	1 bar (14.5 psi)
	Accidental	2 bar (29 psi)
Destruction pressure	3.5 bar (50.75 psi)	
Vacuum switch style	Diaphragm	

Operating curves **Connection**

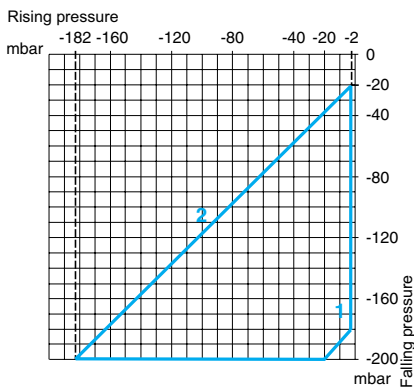

1 Maximum differential
 2 Minimum differential

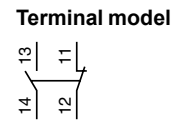
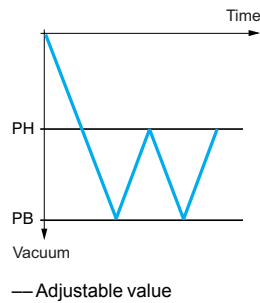

Other versions For switches with alternative tapped cable entries, consult the Customer Care Center.

Size 50 mbar (0.72 psi)
Adjustable differential, for regulation between two thresholds
1 C/O single-pole contact

XMLB pressure switches **With setting scale**

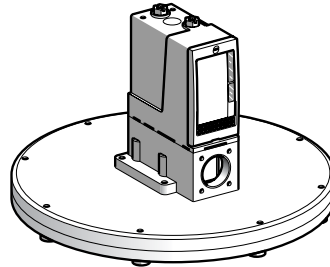

Adjustable range of operating point (PH) (rising pressure)	2.6–50 mbar (0.038–0.72 psi)		
Catalog numbers			
Fluids controlled For materials in contact with fluid, see page 77.	Hydraulic oils, air, up to 320 °F (160 °C)	XMLBL05R2S13	XMLBL05R2S11
	Fresh water, sea water, corrosive fluids, up to 320 °F (160 °C)	XMLBL05S2S13	XMLBL05S2S11
Pressure connection	Conduit/cable entry	1/4"-18 NPTF	G 1/4-19
Electrical connection	Terminals	1/2" NPT	Pg 13.5
		1 x 0.2 to 2 x 2.5 mm ² (1 x 24 to 2 x 14 AWG)	
Weight, lb (kg)	5.34 (2.420)		
Supplementary specifications (not shown under general specifications)			
Possible differential (subtract from PH to get PB)	Min. at low setting	1.4 mbar, -0.8, +1.1 (0.02 psi, -0.01, +0.02)	
	Min. at high setting	4 mbar ±1.4 (0.06 psi ±0.02)	
	Max. at high setting	40 mbar (0.58 psi)	
Maximum allowable pressure	Per cycle	62.5 mbar (0.90 psi)	
	Accidental	112.5 mbar (1.63 psi)	
Destruction pressure	225 mbar (3.26 psi)		
Pressure switch style	Diaphragm		

⁽¹⁾ For, replace **S13** with **S11** (example: XMLBL05R2S13 becomes XMLBL05R2S11).

Operating curves **Connection: Terminal model**

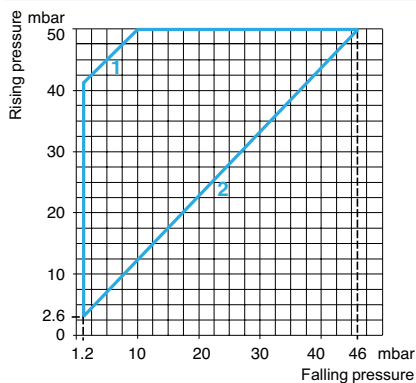

1 Maximum differential
2 Minimum differential

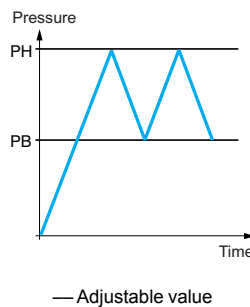

Other versions For switches with DIN 43650A connector or alternative tapped cable entries, consult the Customer Care Center.

Size 5 bar (72.5 psi)
Adjustable differential, for regulation between two thresholds
1 C/O single-pole contact

XMLB vacu-pressure switches **With setting scale**

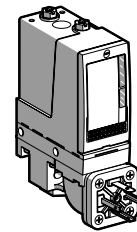
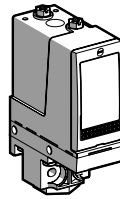

Adjustable range of operating point (PH) (rising pressure)	-0.5 to 5 bar (-7.25 to 72.5 psi)			
Catalog numbers				
Fluids controlled For materials in contact with fluid, see page 77.	Hydraulic oils, fresh water, sea water, air, up to 158 °F (70 °C)	XMLBM05A2S13	XMLBM05A2S11	XMLBM05A2C11
	Hydraulic oils, fresh water, sea water, air, up to 320 °F (160 °C)	XMLBM05B2S13	XMLBM05B2S11	XMLBM05B2C11
	Corrosive fluids, up to 320 °F (160 °C)	XMLBM05C2S13	XMLBM05C2S11	XMLBM05C2C11
	Viscous products, up to 320 °F (160 °C) (G1-1/4" pressure connection)	XMLBM05P2S13	XMLBM05P2S11	XMLBM05P2C11
Pressure connection	1/4"-18 NPTF	G 1/4-19	G 1/4-19	
Electrical connection	Conduit/cable entry	1/2" NPT	Pg 13.5	DIN 43650A, 4-pin male
	Terminals	1 x 0.2 to 2 x 2.5 mm ² (1 x 24 to 2 x 14 AWG)		For suitable female connector, see page 73.
Weight, lb (kg)	1.51 (0.685)		1.58 (0.715)	
Supplementary specifications (not shown under general specifications)				
Possible differential (subtract from PH to get PB)	Min. at low setting	0.5 bar ±0.05 (7.25 psi ±0.72)		
	Min. at high setting	0.5 bar ±0.05 (7.25 psi ±0.72)		
	Max. at high setting	6 bar (87 psi)		
Maximum allowable pressure	Per cycle	6.25 bar (90.62 psi)		
	Accidental	11.25 bar (163.12 psi)		
Destruction pressure	23 bar (333.5 psi)			
Vacu-pressure switch style	Diaphragm			

Operating curves **Connection**

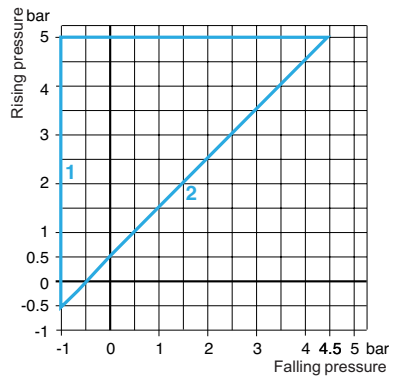

1 Maximum differential
 2 Minimum differential
 — Adjustable value

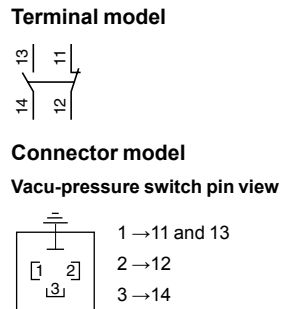
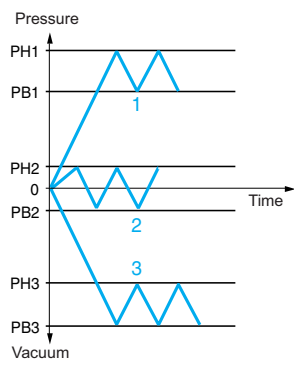

Other versions For switches with alternative tapped cable entries, consult the Customer Care Center.

Size 5 bar (72.5 psi)
Adjustable differential, for regulation between two thresholds
2 C/O single-pole contacts

XMLC vacu-pressure switches **With setting scale**

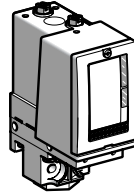

Adjustable range of operating point (PH)
 (rising pressure) -0.55 to 5 bar (-7.97 to 72.5 psi)

Catalog numbers

Fluids controlled For materials in contact with fluid, see page 77.	Hydraulic oils, fresh water, sea water, air, up to 158 °F (70 °C)	XMLCM05A2S13	XMLCM05A2S11
	Hydraulic oils, fresh water, sea water, air, up to 320 °F (160 °C)	XMLCM05B2S13	XMLCM05B2S11
	Corrosive fluids, up to 320 °F (160 °C)	XMLCM05C2S13	XMLCM05C2S11
Pressure connection		1/4"-18 NPTF	G 1/4-19
Electrical connection	Conduit/cable entry	1/2" NPT	Pg 13.5
	Terminals	1 x 0.2 to 2 x 2.5 mm ² (1 x 24 to 2 x 14 AWG)	
Weight, lb (kg)	1.51 (0.685)		

Supplementary specifications (not shown under general specifications)

Possible differential (subtract from PH to get PB)	Min. at low setting	0.45 bar ±0.1 (6.52 psi ±1.45)
	Min. at high setting	0.45 bar ±0.1 (6.52 psi ±1.45)
	Max. at high setting	6 bar (87 psi)
Maximum allowable pressure	Per cycle	6.25 bar (90.62 psi)
	Accidental	11.25 bar (163.12 psi)
Destruction pressure	23 bar (333.5 psi)	
Vacu-pressure switch style	Diaphragm	

Operating curves **Connection**

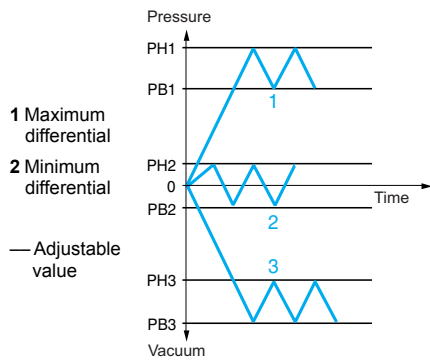
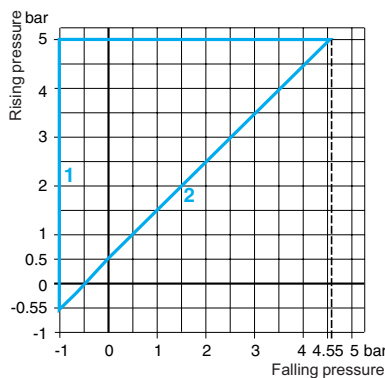

Terminal model

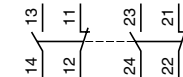

Connector model

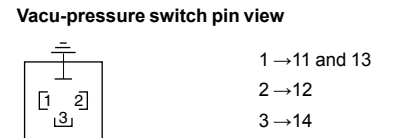

Other versions For switches with alternative tapped cable entries, consult the Customer Care Center.

Size 350 mbar (5.07 psi)
Adjustable differential, for regulation between two thresholds
1 C/O single-pole contact

XMLB pressure switches	With setting scale	With setting scale overpressure 30 bar (435 psi)
------------------------	--------------------	--

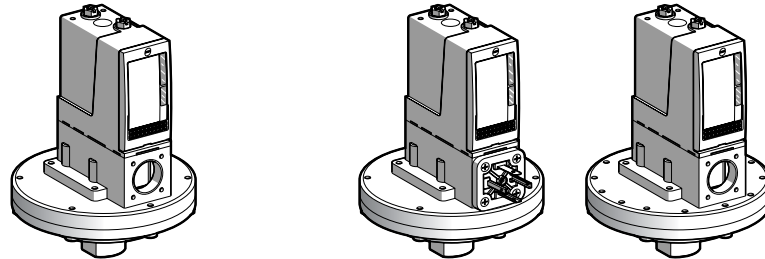

Adjustable range of operating point (PH) (rising pressure)		45–350 mbar (0.65–5.07 psi)			42–330 mbar (0.61–4.78 psi)	
Catalog numbers						
Fluids controlled For materials in contact with fluid, see page 77.	Hydraulic oils, air, up to 320 °F (160 °C)	XMLBL35R2S13	XMLBL35R2S11	XMLBL35R2C11	XMLBS35R2S13	XMLBS35R2S11
	Fresh water, sea water, corrosive fluids, up to 320 °F (160 °C)	XMLBL35S2S13	XMLBL35S2S11	XMLBL35S2C11	—	—
	Viscous products, up to 320 °F (160 °C), G1-1/4" pressure connection	XMLBL35P2S13	XMLBL35P2S11	XMLBL35P2C11	—	—
Pressure connection		1/4"-18 NPTF	G 1/4-19	G 1/4-19	1/4"-18 NPTF	G 1/4-19
Electrical connection	Conduit/cable entry	1/2" NPT	Pg 13.5	DIN 43650A, 4-pin male	1/2" NPT	Pg 13.5
	Terminals	1 x 0.2 to 2 x 2.5 mm ² (1 x 24 to 2 x 14 AWG)		For suitable female connector, see page 73.	1 x 0.2 to 2 x 2.5 mm ² (1 x 24 to 2 x 14 AWG)	
Weight, lb (kg)		5.68 (2.575)		5.71 (2.590)		7.72 (3.500)
Supplementary specifications (not shown under general specifications)						
Possible differential (subtract from PH to get PB)	Min. at low setting	42 mbar -8, +3 (0.60 psi -0.12, +0.04)			33 mbar -8, +3 (0.48 psi -0.12, +0.04)	
	Min. at high setting	50 mbar ±8 (0.72 psi ±0.11)			58 mbar ±8 (0.84 psi ±0.11)	
	Max. at high setting	300 mbar (4.35 psi)			250 mbar (3.62 psi)	
Maximum allowable pressure	Per cycle	1.25 bar (18.12 psi)			30 bar (435 psi)	
	Accidental	2.25 bar (32.62 psi)			37.5 bar (543.75 psi)	
Destruction pressure		4.5 bar (65.25 psi)			67.5 bar (978.75 psi)	
Pressure switch style		Diaphragm				

Operating curves	Connection
	<p>Terminal model</p> <p>Connector model Pressure switch connector pin view</p> <p>1 → 11 and 13 2 → 12 3 → 14</p>
<p>Pressure</p> <p>— Adjustable value</p> <p>1 Maximum differential 2 Minimum differential</p>	

Other versions For switches with alternative tapped cable entries, consult the Customer Care Center.

Size 350 mbar (5.07 psi)
Adjustable differential, for regulation between two thresholds
2 C/O single-pole contacts

XMLC pressure switches	With setting scale	With setting scale overpressure 30 bar (435 psi)
------------------------	--------------------	---

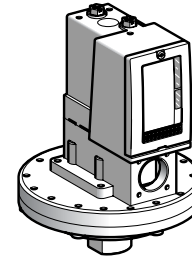
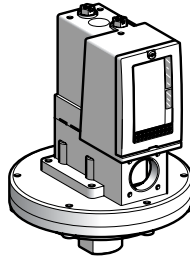

Adjustable range of operating point (PH) (rising pressure)	45–350 mbar (0.65–5.07 psi)	42–330 mbar (0.61–4.78 psi)
--	-----------------------------	-----------------------------

Catalog numbers

Fluids controlled For materials in contact with fluid, see page 77.	Hydraulic oils, air, up to 320 °F (160 °C)	XMLCL35R2S13	XMLCL35R2S11	XMLCS35R2S13	XMLCS35R2S11
	Fresh water, sea water, corrosive fluids, up to 320 °F (160 °C)	XMLCL35S2S13	XMLCL35S2S11	—	—
Pressure connection		1/4"-18 NPTF	G 1/4-19	1/4"-18 NPTF	G 1/4-19
Electrical connection	Conduit/cable entry	1/2" NPT	Pg 13.5	1/2" NPT	Pg 13.5
	Terminals	1 x 0.2 to 2 x 2.5 mm ² (1 x 24 to 2 x 14 AWG)			
Weight, lb (kg)		5.68 (2.575)		7.72 (3.500)	

Supplementary specifications (not shown under general specifications)

Possible differential (subtract from PH to get PB)	Min. at low setting	20 mbar ±20 (0.29 psi ±0.29)	40 mbar ±20 (0.58 psi ±0.29)
	Min. at high setting	35 mbar ±20 (0.51 psi ±0.29)	88 mbar ±20 (1.27 psi ±0.29)
	Max. at high setting	300 mbar (4.35 psi)	230 mbar (3.33 psi)
Maximum allowable pressure	Per cycle	1.25 bar (18.12 psi)	30 bar (435 psi)
	Accidental	2.25 bar (32.62 psi)	37.5 bar (543.75 psi)
Destruction pressure		4.5 bar (65.25 psi)	67.5 bar (978.75 psi)
Pressure switch style		Diaphragm	

Operating curves

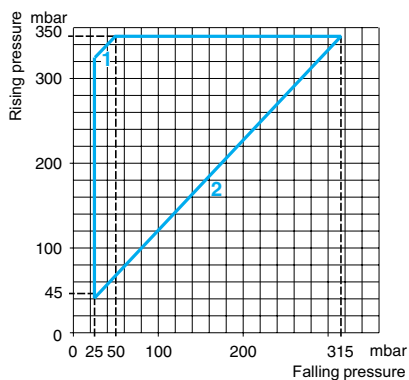

1 Maximum differential
 2 Minimum differential

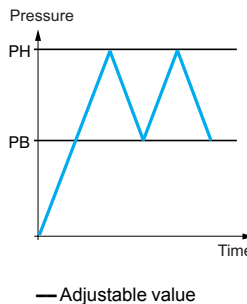

Connection

Terminal model

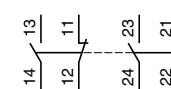

Other versions For switches with alternative tapped cable entries, consult the Customer Care Center.

Size 350 mbar (5.07 psi)
Dual-stage, fixed differential, for detection at each threshold
2 C/O single-pole contacts (one per stage)

XMLD pressure switches Without setting scale

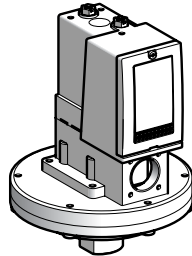

Adjustable range of each operating point (rising pressure)	2nd stage operating point (PH2)	58–350 mbar (0.84–5.07 psi)
	1st stage operating point (PH1)	33–325 mbar (0.48–4.71 psi)
Spread between the two stages (PH2–PH1)		25–310 mbar (0.36–4.50 psi)

Catalog numbers

Fluids controlled For materials in contact with fluid, see page 77.	Hydraulic oils, air, up to 320 °F (160 °C)	XMLDL35R1S13	XMLDL35R1S11
	Fresh water, sea water, corrosive fluids, up to 320 °F (160 °C)	XMLDL35S1S13	XMLDL35S1S11

Pressure connection	1/4"-18 NPTF	G 1/4-19
----------------------------	--------------	----------

Electrical connection	Conduit/cable entry	1/2" NPT	Pg 13.5
	Terminals	1 x 0.2 to 2 x 2.5 mm ² (1 x 24 to 2 x 14 AWG)	

Weight, lb (kg)	5.68 (2.575)
------------------------	--------------

Supplementary specifications (not shown under general specifications)

Inherent differential (subtract from PH1/PH2 to get PB1/PB2)	At low setting	30 mbar ±10 (0.44 psi ±0.15)
	At high setting	30 mbar ±8 (0.44 psi ±0.11)

Maximum allowable Pressure	Per cycle	1.25 bar (18.12 psi)
	Accidental	2.25 bar (32.62 psi)

Destruction pressure	4.5 bar (65.25 psi)
-----------------------------	---------------------

Pressure switch style	Diaphragm
------------------------------	-----------

Operating curves

High setting trip points of contacts 1 and 2

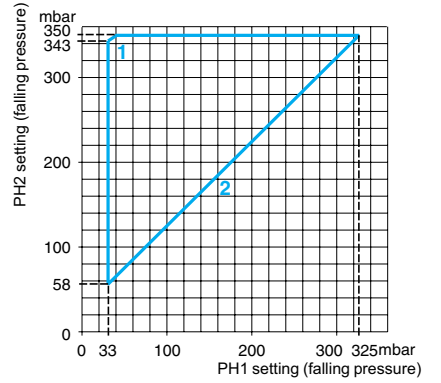

1 Maximum differential
 2 Minimum differential

Inherent differential of contacts 1 and 2

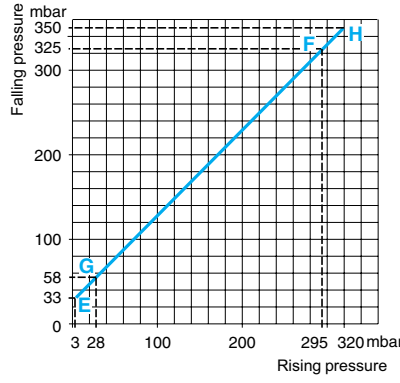

EF Contact 1 (stage 1)
 GH Contact 2 (stage 2)

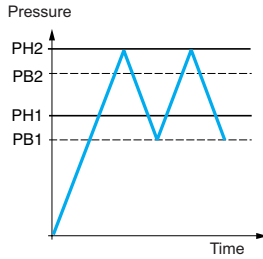

— Adjustable value
 --- Nonadjustable value

Connection

Terminal model

Contact 1 (stage 1) Contact 2 (stage 2)

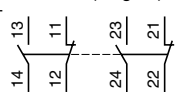

Other versions For switches with alternative tapped cable entries, consult the Customer Care Center.

Size 1 bar (14.5 psi)
Fixed differential, for detection of a single threshold
1 C/O single-pole contact

XMLA pressure switches **With setting scale**

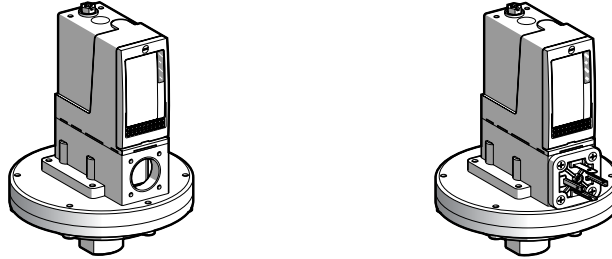

Adjustable range of operating point (PH) (rising pressure) 0.03–1 bar (0.435–14.5 psi)

Catalog numbers

Fluids controlled For materials in contact with fluid, see page 77.	Hydraulic oils, air, up to 320 °F (160 °C)	XMLA001R2S13	XMLA001R2S11	XMLA001R2C11
	Fresh water, sea water, corrosive fluids, up to 320 °F (160 °C)	XMLA001S2S13	XMLA001S2S11	XMLA001S2C11
Pressure connection		1/4"-18 NPTF	G 1/4-19	G 1/4-19
Electrical connection	Conduit/cable entry	Terminals: 1/2" NPT,	Pg 13.5	DIN 43650A, 4-pin male
	Terminals	1 x 0.2 to 2 x 2.5 mm ² (1 x 24 to 2 x 14 AWG)		For suitable female connector, see page 73.
Weight, lb (kg)		5.63 (2.555)		5.67 (2.570)

Supplementary specifications (not shown under general specifications)

Inherent differential (subtract from PH to get PB)	At low setting	0.02 bar ±0.01 (0.29 psi ±0.14)
	At high setting	0.04 bar ±0.01 (0.58 psi ±0.14)
Maximum allowable pressure	Per cycle	1.25 bar (18.12 psi)
	Accidental	2.25 bar (32.62 psi)
Destruction pressure		4.5 bar (65.25 psi)

Pressure switch style Diaphragm

Operating curves **Connection**

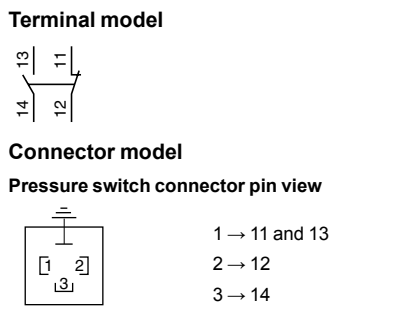
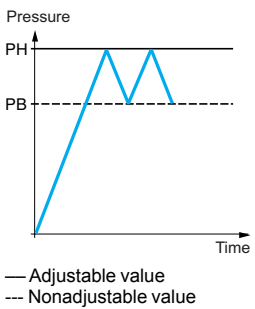
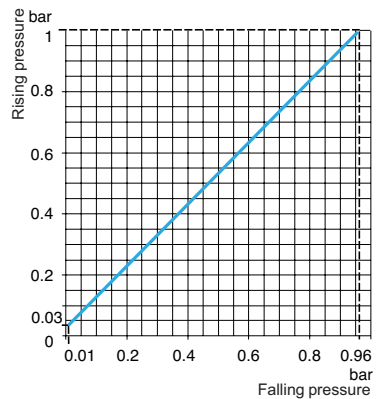

Other versions For switches with alternative tapped cable entries, consult the Customer Care Center.

Size 1 bar (14.5 psi)
Adjustable differential, for regulation between two thresholds
1 C/O single-pole contact

XMLB pressure switches **With setting scale**

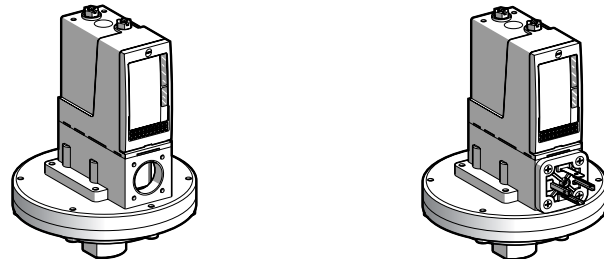

Adjustable range of operating point (PH) (rising pressure)	0.05–1 bar (0.72–14.5 psi)			
Electrical connection	Terminals	DIN connector		
Catalog numbers				
Fluids controlled For materials in contact with fluid, see page 77.	Hydraulic oils, air, up to 320 °F (160 °C)	XMLB001R2S13	XMLB001R2S11	XMLB001R2C11
	Fresh water, sea water, corrosive fluids, up to 320 °F (160 °C)	XMLB001S2S13	XMLB001S2S11	XMLB001S2C11
	Viscous products, up to 320 °F (160 °C) (G1-1/4" pressure connection)	XMLB001P2S13	XMLB001P2S11	XMLB001P2C11
Pressure connection	1/4"-18 NPTF	G 1/4-19	G 1/4-19	
Electrical connection	Conduit/cable entry	1/2" NPT	Pg 13.5	DIN 43650A, 4-pin male
	Terminals	1 x 0.2 to 2 x 2.5 mm ² (1 x 24 to 2 x 14 AWG)		For suitable female connector, see page 73.
Weight, lb (kg)	5.68 (2.575)		5.71 (2.590)	
Supplementary specifications (not shown under general specifications)				
Possible differential (subtract from PH to get PB)	Min. at low setting	0.04 bar ±10 (0.58 psi ±0.14)		
	Min. at high setting	0.06 bar ±20 (0.87 psi ±0.29)		
	Max. at high setting	0.75 bar (10.87 psi)		
Maximum allowable pressure	Per cycle	1.25 bar (18.12 psi)		
	Accidental	2.25 bar (32.62 psi)		
Destruction pressure	4.5 bar (65.25 psi)			
Pressure switch style	Diaphragm			

Operating curves **Connection**

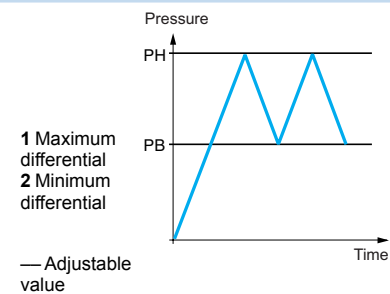
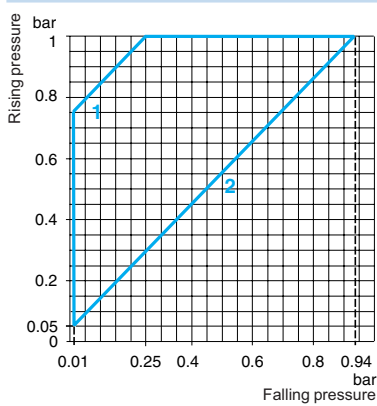

Terminal model



Connector model

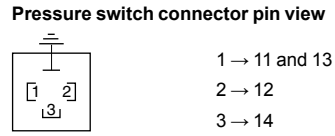

Other versions For switches with alternative tapped cable entries, consult the Customer Care Center.

Size 1 bar (14.5 psi)
Adjustable differential, for regulation between two thresholds
2 C/O single-pole contacts

XMLC pressure switches **With setting scale**

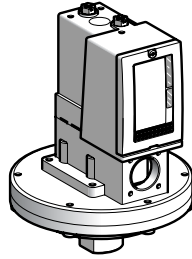

Adjustable range of operating point (PH) (rising pressure)	0.05–1 bar (0.725–14.5 psi)
--	-----------------------------

Electrical connection	Terminals
------------------------------	-----------

Catalog numbers

Fluids controlled For materials in contact with fluid, see page 77.	Hydraulic oils, air, up to 320 °F (160 °C)	XMLC001R2S13	XMLC001R2S11
	Fresh water, sea water, corrosive fluids, up to 320 °F (160 °C)	XMLC001S2S13	XMLC001S2S11

Pressure connection	1/4"-18 NPTF	G 1/4-19
----------------------------	--------------	----------

Electrical connection	Conduit/cable entry	1/2" NPT	Pg 13.5
	Terminals	1 x 0.2 to 2 x 2.5 mm ² (1 x 24 to 2 x 14 AWG)	

Weight, lb (kg)	5.63 (2.555)
------------------------	--------------

Supplementary specifications (not shown under general specifications)

Possible differential (subtract from PH to get PB)	Min. at low setting	0.03 bar ±0.01 (0.43 psi ±0.14)
	Min. at high setting	0.04 bar ±0.03 (0.58 psi ±0.43)
	Max. at high setting	0.8 bar (11.6 psi)

Maximum allowable pressure	Per cycle	1.25 bar (18.12 psi)
	Accidental	2.25 bar (32.62 psi)

Destruction pressure	4.5 bar (65.25 psi)
-----------------------------	---------------------

Pressure switch style	Diaphragm
------------------------------	-----------

Operating curves **Connection**

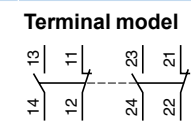
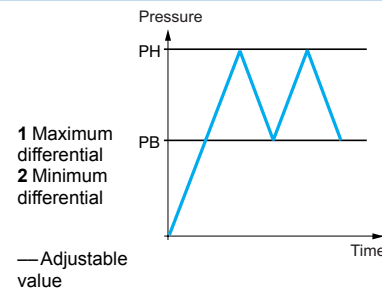
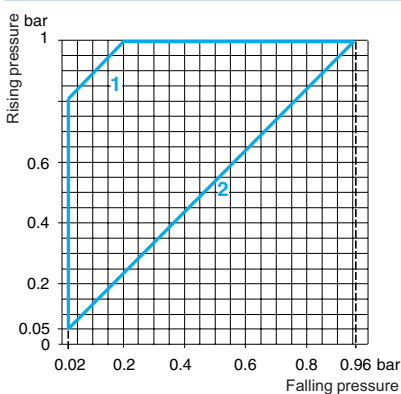

Other versions For switches with alternative tapped cable entries, consult the Customer Care Center.

Size 1 bar (14.5 psi)
Dual-stage, fixed differential, for detection at each threshold
2 C/O single-pole contacts (one per stage)

XMLD pressure switches Without setting scale

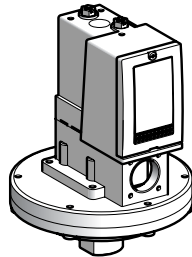

Adjustable range of each operating point (rising pressure)	2nd stage operating point (PH2)	0.12–1 bar (1.74–14.5 psi)
	1st stage operating point (PH1)	0.04–0.92 bar (0.58–13.34 psi)
Spread between the two stages (PH2–PH1)		0.08–0.73 bar (1.16–10.59 psi)

Catalog numbers

Fluids controlled For materials in contact with fluid, see page 77.	Hydraulic oils, air, up to 320 °F (160 °C)	XMLD001R1S13	XMLD001R1S11
	Fresh water, sea water, corrosive fluids, up to 320 °F (160 °C)	XMLD001S1S13	XMLD001S1S11

Pressure connection	1/4"-18 NPTF	G 1/4-19
----------------------------	--------------	----------

Electrical connection	Conduit/cable entry	1/2" NPT	Pg 13.5
	Terminals	1 x 0.2 to 2 x 2.5 mm ² (1 x 24 to 2 x 14 AWG)	

Weight, lb (kg)	5.68 (2.575)
------------------------	--------------

Supplementary specifications (not shown under general specifications)

Inherent differential (subtract from PH1/PH2 to get PB1/PB2)	At low setting	0.03 bar ±0.01 (0.44 psi ±0.14)
	At high setting	0.07 bar ±0.04 (1.02 psi ±0.58)

Maximum allowable pressure	Per cycle	1.25 bar (18.12 psi)
	Accidental	2.25 bar (32.62 psi)

Destruction pressure	4.5 bar (65.25 psi)
-----------------------------	---------------------

Pressure switch style	Diaphragm
------------------------------	-----------

Operating curves

High setting trip points of contacts 1 and 2

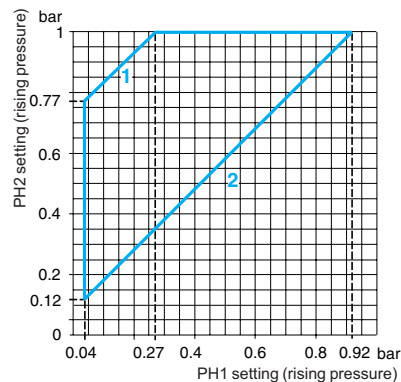

1 Maximum differential
 2 Minimum differential

Inherent differential of contacts 1 and 2

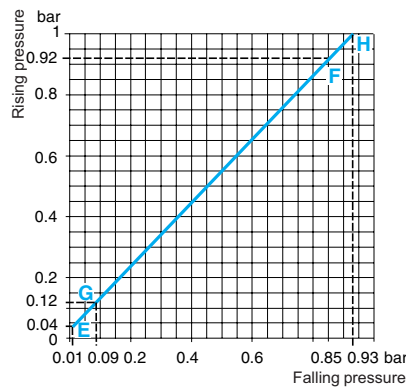

EF Contact 1 (stage 1)
 GH Contact 2 (stage 2)

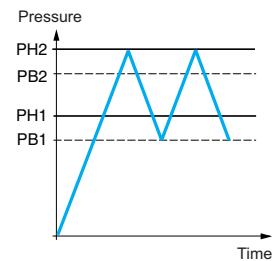

— Adjustable value
 --- Nonadjustable value

Connection: Terminal model

Contact 2 (stage 2) Contact 1 (stage 1)

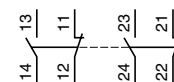

Other versions For switches with alternative tapped cable entries, consult the Customer Care Center.

Size 2.5 bar (36.25 psi)
Fixed differential, for detection of a single threshold
1 C/O single-pole contact

XMLA pressure switches **With setting scale**



Adjustable range of operating point (PH)
 (rising pressure) 0.15–2.5 bar (2.17–36.25 psi)

Catalog numbers

Fluids controlled For materials in contact with fluid, see page 77.	Hydraulic oils, fresh water, sea water, air, up to 158 °F (70 °C)	XMLA002A2S13	XMLA002A2S11	XMLA002A2C11
	Hydraulic oils, fresh water, sea water, air, up to 320 °F (160 °C)	XMLA002B2S13	XMLA002B2S11	XMLA002B2C11
	Corrosive fluids, up to 320 °F (160 °C)	XMLA002C2S13	XMLA002C2S11	XMLA002C2C11
Pressure connection		1/4"-18 NPTF	G 1/4-19	G 1/4-19
Electrical connection	Conduit/cable entry	1/2" NPT	Pg 13.5	DIN 43650A, 4-pin male
	Terminals	1 x 0.2 to 2 x 2.5 mm ² (1 x 24 to 2 x 14 AWG)		For suitable female connector, see page 73.
Weight, lb (kg)		2.19 (0.995)		2.23 (1.010)

Supplementary specifications (not shown under general specifications)

Inherent differential (subtract from PH to get PB)	At low setting	0.13 bar ±0.03 (1.88 psi ±0.43)
	At high setting	0.13 bar ±0.03 (1.88 psi ±0.43)
Maximum allowable Pressure	Per cycle	5 bar (72.5 psi)
	Accidental	9 bar (130.5 psi)
Destruction pressure		18 bar (261 psi)
Pressure switch style		Diaphragm

Operating curves **Connection**

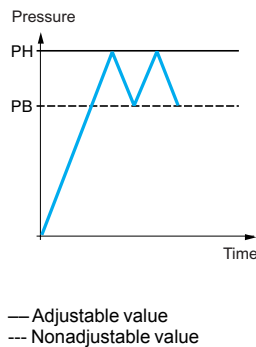
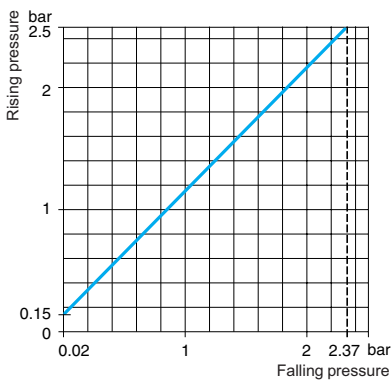

Terminal model



Connector model

Pressure switch connector pin view

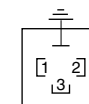

- 1 → 11 and 13
- 2 → 12
- 3 → 14

Other versions For switches with alternative tapped cable entries, consult the Customer Care Center.

Size 2.5 bar (36.25 psi)
Adjustable differential, for regulation between two thresholds
1 C/O single-pole contact

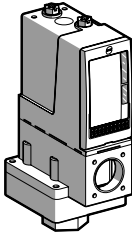
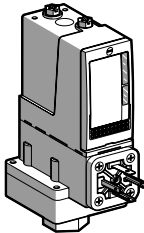
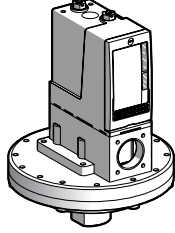
XMLB pressure switches	With setting scale	With setting scale overpressure 30 bar (435 psi)	
			

Adjustable range of operating point (PH) (rising pressure)	0.3–2.5 bar (4.35–36.25 psi)
---	------------------------------

Catalog numbers

Fluids controlled For materials in contact with fluid, see page 77.	Hydraulic oils, fresh water, sea water, air, up to 158 °F (70 °C)	XMLB002A2S13	XMLB002A2S11	XMLB002A2C11	—	—
	Hydraulic oils, fresh water, sea water, air, up to 320 °F (160 °C)	XMLB002B2S13	XMLB002B2S11	XMLB002B2C11	—	—
	Hydraulic oils, fresh water, air, up to 320 °F (160 °C)	—	—	—	XMLBS02B2S13	XMLBS02B2S11
	Corrosive fluids, up to 320 °F (160 °C)	XMLB002C2S13	XMLB002C2S11	XMLB002C2C11	—	—

Pressure connection	1/4"-18 NPTF	G 1/4-19	G 1/4-19	1/4"-18 NPTF	G 1/4-19	
Electrical connection	Conduit/cable entry	1/2" NPT	Pg 13.5	DIN 43650A, 4-pin male	1/2" NPT	Pg 13.5
	Terminals	1 x 0.2 – 2 x 2.5 mm ² (1 x 24 to 2 x 14 AWG)		For suitable female connector, see page 73.	1 x 0.2 – 2 x 2.5 mm ² (1 x 24 to 2 x 14 AWG)	
Weight, lb (kg)		2.24 (1.015)	2.27 (1.030)	7.72 (3.500)		

Supplementary specifications (not shown under general specifications)

Possible differential (subtract from PH to get PB)	Min. at low setting	0.16 bar, -0.8 mbar, +1.1 mbar (2.32 psi, -0.01, +0.02)	0.1 bar -0.8 mbar, +1.1 mbar (1.45 psi -0.01, +0.02)
	Min. at high setting	0.21 bar ±1.4 mbar (3.04 psi ±0.02)	0.22 bar ±1.4 mbar (3.19 psi ±0.02)
	Max. at high setting	1.75 bar (25.37 psi)	1.45 bar (21 psi)
Maximum allowable pressure	Per cycle	5 bar (72.5 psi)	30 bar (435 psi)
	Accidental	9 bar (130.5 psi)	37.5 bar (543.75 psi)
Destruction pressure		18 bar (261 psi)	67.5 bar (978.75 psi)
Pressure switch style		Diaphragm	

Operating curves

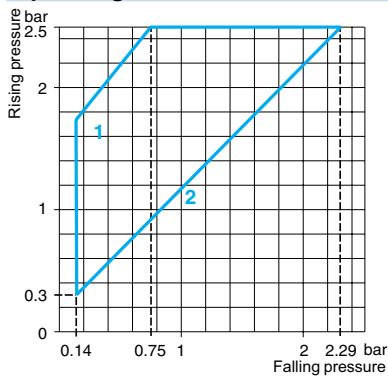

1 Maximum differential
 2 Minimum differential

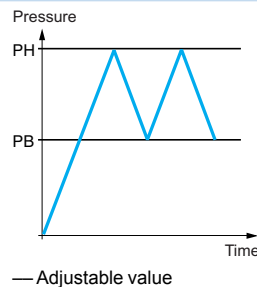

Connection

Terminal model



Connector model
Pressure switch connector pin view

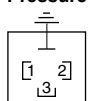

1 → 11 and 13
 2 → 12
 3 → 14

Other versions For switches with alternative tapped cable entries, consult the Customer Care Center.

Size 2.5 bar (36.25 psi)
Adjustable differential, for regulation between two thresholds
2 C/O single-pole contacts

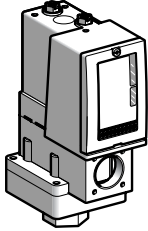
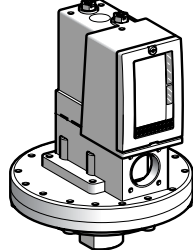
XMLC pressure switches	With setting scale	With setting scale overpressure 30 bar (435 psi)
		

Adjustable range of operating point (PH) (rising pressure)	0.3–2.5 bar (4.35–36.25 psi)
--	------------------------------

Catalog numbers					
Fluids controlled For materials in contact with fluid, see page 77.	Hydraulic oils, fresh water, air, up to 320 °F (160 °C)	—	—	XMLCS02B2S13	XMLCS02B2S11
	Hydraulic oils, fresh water, sea water, air, up to 320 °F (160 °C)	XMLC002B2S13	XMLC002B2S11	—	—
	Corrosive fluids, up to 320 °F (160 °C)	XMLC002C2S13	XMLC002C2S11	—	—
Pressure connection		1/4"-18 NPTF	G 1/4-19	1/4"-18 NPTF	G 1/4-19
Electrical connection	Conduit/cable entry	1/2" NPT	Pg 13.5	1/2" NPT	Pg 13.5
	Terminals	1 x 0.2 to 2 x 2.5 mm ² (1 x 24 to 2 x 14 AWG)			
Weight, lb (kg)	2.19 (0.995)		7.72 (3.500)		

Supplementary specifications (not shown under general specifications)				
Possible differential (subtract from PH to get PB)	Min. at low setting	0.13 bar ±0.02 (1.89 psi ±0.29)		0.1 bar ±0.02 (1.45 psi ±0.29)
	Min. at high setting	0.17 bar ±0.03 (2.47 psi ±0.43)		0.18 bar ±0.03 (2.61 psi ±0.43)
	Max. at high setting	2 bar (29 psi)		1.25 bar (18.12 psi)
Maximum allowable pressure	Per cycle	5 bar (72.5 psi)		30 bar (435 psi)
	Accidental	9 bar (130.5 psi)		37.5 bar (543.75 psi)
Destruction pressure	18 bar (261 psi)		67.5 bar (978.75 psi)	
Pressure switch style	Diaphragm			

Operating curves	Connection
<p>1 Maximum differential 2 Minimum differential</p> <p>— Adjustable value</p>	

Other versions For switches with alternative tapped cable entries, consult the Customer Care Center.

Size 2.5 bar (36.25 psi)
Dual-stage, fixed differential, for detection at each threshold
2 C/O single-pole contacts (one per stage)

XMLD pressure switches Without setting scale

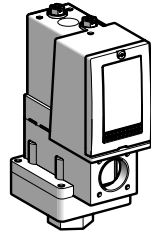

Adjustable range of each operating point (rising pressure)	2nd stage operating point (PH2)	0.34–2.5 bar (4.93–36.25 psi)
	1st stage operating point (PH1)	0.2–2.36 bar (2.9–34.22 psi)
Spread between the two stages (PH2–PH1)		0.14–1.5 bar (2.03–21.75 psi)

Catalog numbers

Fluids controlled For materials in contact with fluid, see page 77.	Hydraulic oils, fresh water, sea water, air, up to 320 °F (160 °C)	XMLD002B1S13	XMLD002B1S11
	Corrosive fluids, up to 320 °F (160 °C)	XMLD002C1S13	XMLD002C1S11
Pressure connection		1/4"-18 NPTF	G 1/4-19
Electrical connection	Conduit/cable entry	1/2" NPT	Pg 13.5
	Terminals	1 x 0.2 to 2 x 2.5 mm ² (1 x 24 to 2 x 14 AWG)	
Weight, lb (kg)		2.24 (1.015)	

Supplementary specifications (not shown under general specifications)

Inherent differential (subtract from PH1/PH2 to get PB1/PB2)	At low setting	0.14 bar ±0.04 (2.03 psi ±0.58)
	At high setting	0.19 bar ±0.07 (2.76 psi ±1.02)
Maximum allowable pressure	Per cycle	5 bar (72.5 psi)
	Accidental	9 bar (130.5 psi)
Destruction pressure		18 bar (261 psi)
Pressure switch style		Diaphragm

Operating curves

High setting trip points of contacts 1 and 2

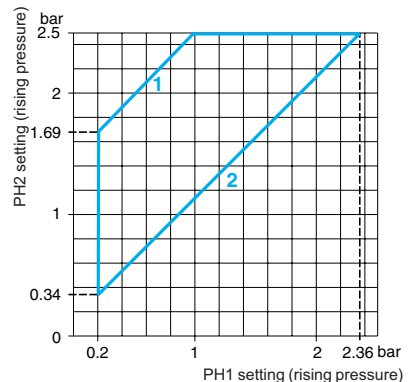

1 Maximum differential
 2 Minimum differential

Inherent differential of contacts 1 and 2

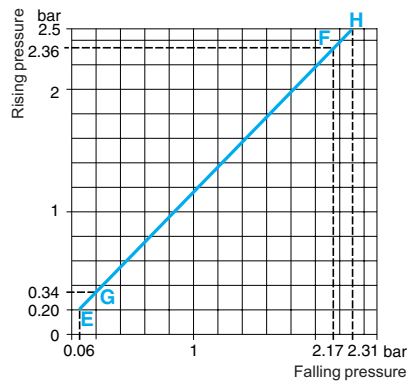

EF Contact 1 (stage 1)
 GH Contact 2 (stage 2)

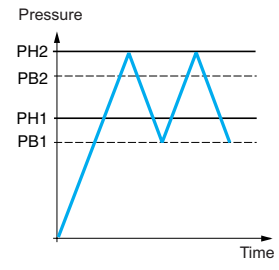

— Adjustable value
 --- Nonadjustable value

Connection: Terminal model

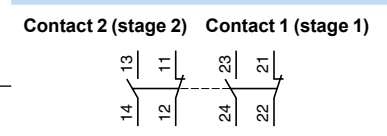

Other versions For switches with alternative tapped cable entries, consult the Customer Care Center.

Size 4 bar (58 psi)
Fixed differential, for detection of a single threshold
1 C/O single-pole contact

XMLA pressure switches **With setting scale**

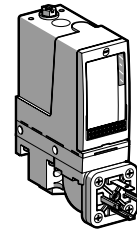
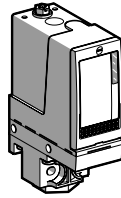

Adjustable range of operating point (PH) (rising pressure)	0.4–4 bar (5.8–58 psi)
--	------------------------

Catalog numbers

Fluids controlled For materials in contact with fluid, see page 77.	Hydraulic oils, fresh water, sea water, air, up to 158 °F (70 °C)	XMLA004A2S13	XMLA004A2S11	XMLA004A2C11
	Hydraulic oils, fresh water, sea water, air, up to 320 °F (160 °C)	XMLA004B2S13	XMLA004B2S11	XMLA004B2C11
	Corrosive fluids, up to 320 °F (160 °C)	XMLA004C2S13	XMLA004C2S11	XMLA004C2C11
	Viscous products, up to 320 °F (160 °C) (G1-1/4" pressure connection)	XMLA004P2S13	XMLA004P2S11	XMLA004P2C11

Pressure connection	1/4"-18 NPTF	G 1/4-19	G 1/4-19
----------------------------	--------------	----------	----------

Electrical connection	Conduit/cable entry	1/2" NPT	Pg 13.5	DIN 43650A, 4-pin male
	Terminals	1 x 0.2 to 2 x 2.5 mm ² (1 x 24 to 2 x 14 AWG)		For suitable female connector, see page 73.

Weight, lb (kg)	1.51 (0.685)	1.58 (0.715)
------------------------	--------------	--------------

Supplementary specifications (not shown under general specifications)

Inherent differential (subtract from PH to get PB)	At low setting	0.35 bar ±0.03 (5.07 psi ±0.43)
	At high setting	0.35 bar ±0.03 (5.07 psi ±0.43)
Maximum allowable pressure	Per cycle	5 bar (72.5 psi)
	Accidental	9 bar (130.5 psi)
Destruction pressure	18 bar (261 psi)	

Pressure switch style	Diaphragm
------------------------------	-----------

Operation curves **Connection**

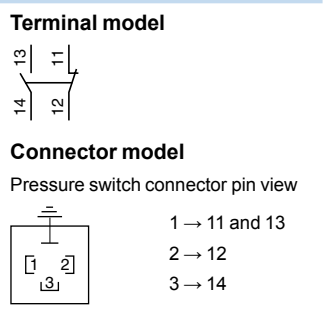
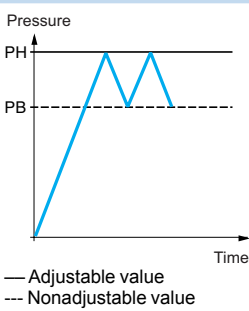
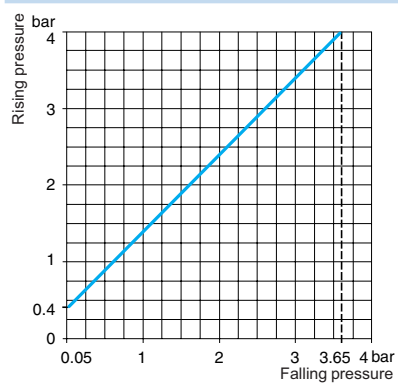

Other versions For switches with alternative tapped cable entries, consult the Customer Care Center.

Size 4 bar (58 psi)
Adjustable differential, for regulation between 2 thresholds
1 C/O single-pole contact

XMLB pressure switches	With setting scale	With setting scale overpressure 30 bar (435 psi)
-------------------------------	---------------------------	---

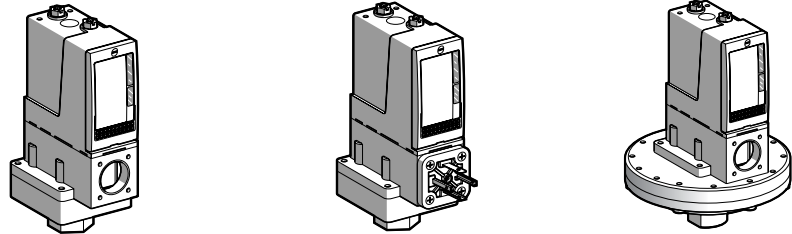

Adjustable range of operating point (PH) (rising pressure)	0.25–4 bar (3.62–58 psi)
--	--------------------------

Catalog numbers

Fluids controlled For materials in contact with fluid, see page 77.	Hydraulic oils, fresh water, sea water, air, up to 158 °F (70 °C)	XMLB004A2S13	XMLB004A2S11	XMLB004A2C11	—	—
	Hydraulic oils, fresh water, sea water, air, up to 320 °F (160 °C)	XMLB004B2S13	XMLB004B2S11	XMLB004B2C11	—	—
	Hydraulic oils, freshwater, air, up to 320 °F (160 °C)	—	—	—	XMLBS04B2S13	XMLBS04B2S11
	Corrosive fluids, up to 320 °F (160 °C)	XMLB004C2S13	XMLB004C2S11	XMLB004C2C11	—	—
Pressure connection	Conduit/cable entry	1/4"-18 NPTF	G 1/4-19	G 1/4-19	1/4"-18 NPTF	G 1/4-19
Electrical connection	Terminals	1/2" NPT	Pg 13.5	DIN 43650A, 4-pin male	1/2" NPT	Pg 13.5
		1 x 0.2 to 2 x 2.5 mm ² (1 x 24 to 2 x 14 AWG)			For suitable female connector, see page 73.	
Weight, lb (kg)		2.24 (1.015)		2.27 (1.030)	7.72 (3.500)	

Supplementary specifications (not shown under general specifications)

Possible differential (subtract from PH to get PB)	Min. at low setting	0.2 bar ±0.01 (2.9 psi ±0.14)	0.15 bar ±0.01 (2.18 psi ±0.14)
	Min. at high setting	0.25 bar, -0.03, +0.05 (3.62 psi, -0.43, +0.72)	0.34 bar, -0.03, +0.05 (4.93 psi, -0.43, +0.72)
	Max. at high setting	2.4 bar (34.8 psi)	2.46 bar (35.67 psi)
Maximum allowable pressure	Per cycle	5 bar (72.5 psi)	30 bar (435 psi)
	Accidental	9 bar (130.5 psi)	37.5 bar (543.75 psi)
Destruction pressure		18 bar (261 psi)	67.5 bar (978.75 psi)
Pressure switch style		Diaphragm	

Operating curves

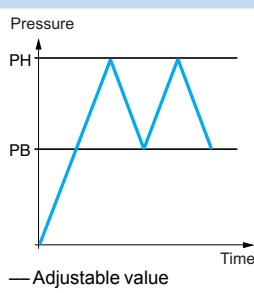
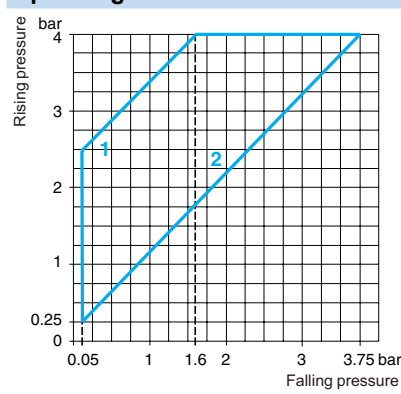

1 Maximum differential
 2 Minimum differential

Connection

Terminal model



Connector model

Pressure switch connector pin view

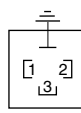

1 → 11 and 13
 2 → 12
 3 → 14

Other versions For switches with alternative tapped cable entries, consult the Customer Care Center.

Size 4 bar (58 psi)
Adjustable differential, for regulation between two thresholds
2 C/O single-pole contacts

XMLC pressure switches	With setting scale	With setting scale overpressure 30 bar (435 psi)
-------------------------------	---------------------------	---

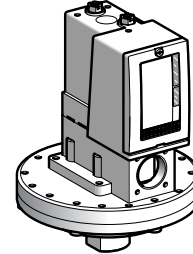
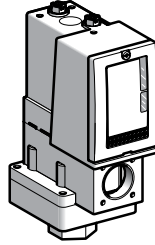

Adjustable range of operating point (PH) (rising pressure)	0.3–4 bar (4.35–58 psi)
--	-------------------------

Catalog numbers

Fluids controlled For materials in contact with fluid, see page 77.	Hydraulic oils, fresh water, air, up to 320 °F (160 °C)	—	—	XMLCS04B2S13	XMLCS04B2S11
	Hydraulic oils, fresh water, sea water, air, up to 320 °F (160 °C)	XMLC004B2S13	XMLC004B2S11	—	—
	Corrosive fluids, up to 320 °F (160 °C)	XMLC004C2S13	XMLC004C2S11	—	—

Pressure connection		1/4"-18 NPTF	G 1/4-19	1/4"-18 NPTF	G 1/4-19
----------------------------	--	--------------	----------	--------------	----------

Electrical connection	Conduit/cable entry	1/2" NPT	Pg 13.5	1/2" NPT	Pg 13.5
	Terminals	1 x 0.2 to 2 x 2.5 mm ² (1 x 24 to 2 x 14 AWG)			

Weight, lb (kg)	1.51 (0.685)	7.72 (3.500)
------------------------	--------------	--------------

Supplementary specifications (not shown under general specifications)

Possible differential (subtract from PH to get PB)	Min. at low setting	0.15 bar ±0.02 (2.18 psi ±0.29)	0.1 bar ±0.02 (1.45 psi ±0.29)
	Min. at high setting	0.17 bar ±0.02 (2.47 psi ±0.29)	0.25 bar ±0.02 (3.62 psi ±0.29)
	Max. at high setting	2.5 bar (36.25 psi)	2.20 bar (31.9 psi)
Maximum allowable pressure	Per cycle	5 bar (72.5 psi)	30 bar (435 psi)
	Accidental	9 bar (130.5 psi)	37.5 bar (543.75 psi)
Destruction pressure		18 bar (261 psi)	67.5 bar (978.75 psi)

Pressure switch style	Diaphragm
------------------------------	-----------

Operating curves

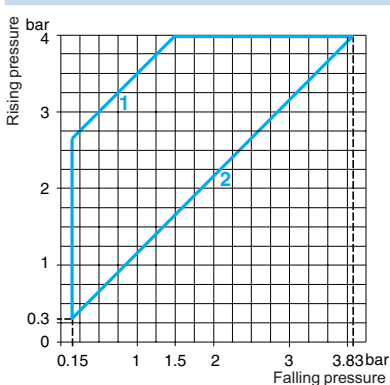

1 Maximum differential
 2 Minimum differential

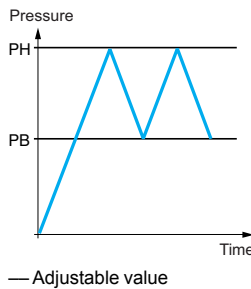

Connection

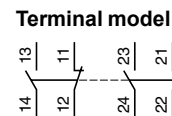

Other versions For switches with alternative tapped cable entries, consult the Customer Care Center.

Size 4 bar (58 psi)
Dual-stage, fixed differential, for detection at each threshold
2 C/O single-pole contacts (one per stage)

XMLD pressure switches Without setting scale

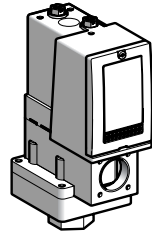

Adjustable range of each operating point rising pressure)	2nd stage operating point (PH2)	0.40–4 bar (5.8–58 psi)	
	1st stage operating point (PH1)	0.19–3.79 bar (2.76–54.96 psi)	
Spread between the two stages (PH2–PH1)		0.21–2.18 bar (3.05–31.61 psi)	
Catalog numbers			
Fluids controlled For materials in contact with fluid, see page 77.	Hydraulic oils, fresh water, sea water, air, up to 320 °F (160 °C)	XMLD004B1S13	XMLD004B1S11
	Corrosive fluids, up to 320 °F (160 °C)	XMLD004C1S13	XMLD004C1S11
Pressure connection		1/4"-18 NPTF	G 1/4-19
Electrical connection	Conduit/cable entry	1/2" NPT	Pg 13.5
	Terminals	1 x 0.2 to 2 x 2.5 mm ² (1 x 24 to 2 x 14 AWG)	
Weight, lb (kg)		2.24 (1.015)	
Supplementary specifications (not shown under general specifications)			
Inherent differential (subtract from PH1/PH2 to get PB1/PB2)	At low setting	0.15 bar ±0.03 (2.18 psi ±0.43)	
	At high setting	0.19 bar, ±0.03 (2.76 psi ±0.43)	
Maximum allowable pressure	Per cycle	5 bar (72.5 psi)	
	Accidental	9 bar (130.5 psi)	
Destruction pressure		18 bar (261 psi)	
Pressure switch style		Diaphragm	

Operating curves

High setting trip points of contacts 1 and 2

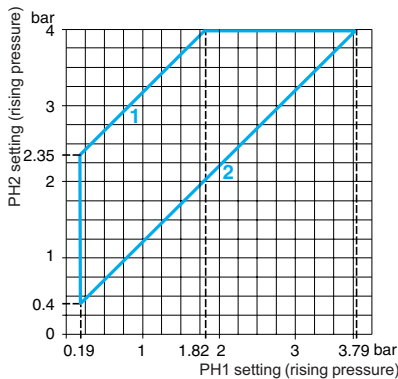

1 Maximum differential
2 Minimum differential
EF Contact 1 (stage 1)
GH Contact 2 (stage 2)

Inherent differential of contacts 1 and 2

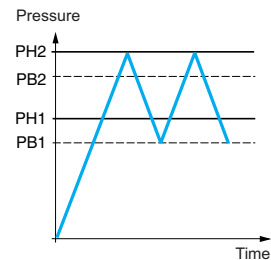
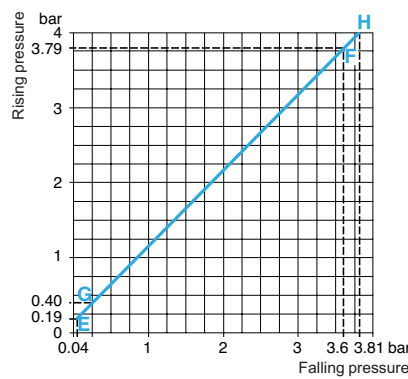

— Adjustable value
 --- Nonadjustable value

Connection: Terminal model

Contact 2 (stage 2) Contact 1 (stage 1)

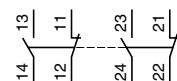

Other versions For switches with alternative tapped cable entries, consult the Customer Care Center.

Size 10 bar (145 psi)
Fixed differential, for detection of a single threshold
1 C/O single-pole contact

XMLA pressure switches **With setting scale**



Adjustable range of operating point (PH) (rising pressure)	0.6–10 bar (8.7–145 psi)
--	--------------------------

Catalog numbers

Fluids controlled For materials in contact with fluid, see page 77.	Hydraulic oils, fresh water, sea water, air, up to 158 °F (70 °C)	XMLA010A2S13	XMLA010A2S11	XMLA010A2C11
	Hydraulic oils, fresh water, sea water, air, up to 320 °F (160 °C)	XMLA010B2S13	XMLA010B2S11	XMLA010B2C11
	Corrosive fluids, up to 320 °F (160 °C)	XMLA010C2S13	XMLA010C2S11	XMLA010C2C11
	Viscous products, up to 320 °F (160 °C) (G1-1/4" pressure connection)	XMLA010P2S13	XMLA010P2S11	XMLA010P2C11

Pressure connection	1/4"-18 NPTF	G 1/4-19	G 1/4-19
----------------------------	--------------	----------	----------

Electrical connection	Conduit/cable entry	1/2" NPT	Pg 13.5	DIN 43650A, 4-pin male
	Terminals	1 x 0.2 to 2 x 2.5 mm ² (1 x 24 to 2 x 14 AWG)		For suitable female connector, see page 73.

Weight, lb (kg)	1.51 (0.685)	1.58 (0.715)
------------------------	--------------	--------------

Supplementary specifications (not shown under general specifications)

Inherent differential (subtract from PH to get PB)	At low setting	0.5 bar ±0.05 (7.25 psi ±0.72)
	At high setting	0.5 bar ±0.05 (7.25 psi ±0.72)

Maximum allowable pressure	Per cycle	12.5 bar (181.25 psi)
	Accidental	22.5 bar (326.25 psi)

Destruction pressure	45 bar (652.5 psi)
-----------------------------	--------------------

Pressure switch style	Diaphragm
------------------------------	-----------

Operating curves **Connection**

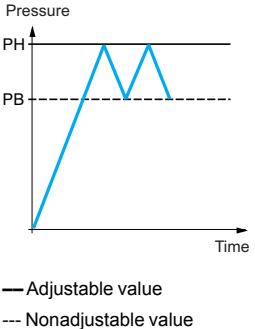
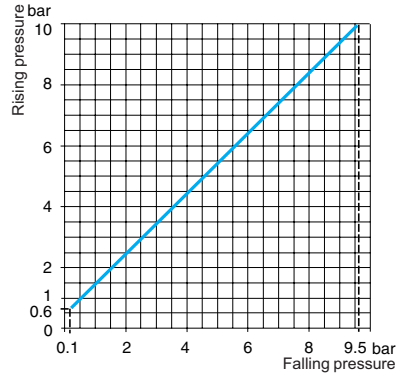

Terminal model



Connector model

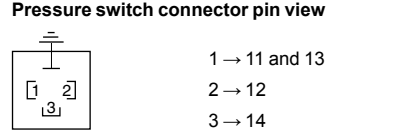

Other versions For switches with alternative tapped cable entries, consult the Customer Care Center.

Size 10 bar (145 psi)
Adjustable differential, for regulation between two thresholds
1 C/O single-pole contact

XMLB pressure switches	With setting scale	With setting scale, overpressure 30 bar (435 psi)
-------------------------------	---------------------------	--

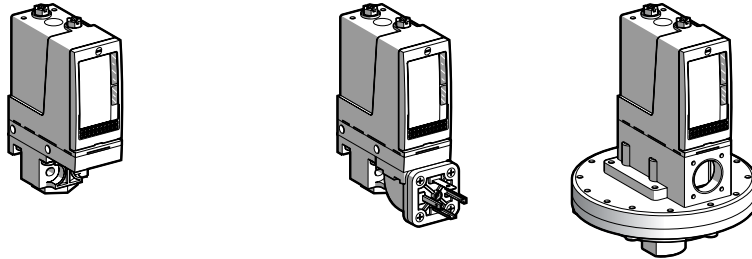

Adjustable range of operating point (PH) (rising pressure)		0.7–10 bar (10.15–145 psi)				
Catalog numbers						
Fluids controlled For materials in contact with fluid, see page 77.	Hydraulic oils, fresh water, sea water, air, up to 158 °F (70 °C)	XMLB010A2S13	XMLB010A2S11	XMLB010A2C11	—	—
	Hydraulic oils, fresh water, air, up to 320 °F (160 °C)	—	—	—	XMLBS10A2S13	XMLBS10A2S11
	Hydraulic oils, fresh water, air, up to 320 °F (160 °C)	XMLB010B2S13	XMLB010B2S11	XMLB010B2C11	—	—
	Corrosive fluids, up to 320 °F (160 °C)	XMLB010C2S13	XMLB010C2S11	XMLB010C2C11	—	—
	Viscous products, up to 320 °F (160 °C) (G1-1/4" pressure connection)	XMLB010P2S13	XMLB010P2S11	XMLB010P2C11	—	—
Pressure connection		1/4"-18 NPTF	G 1/4-19	G 1/4-19	1/4"-18 NPTF	G 1/4-19
Electrical connection	Conduit/cable entry	1/2" NPT	Pg 13.5	DIN 43650A, 4-pin male	1/2" NPT	Pg 13.5
	Terminals	1 x 0.2 to 2 x 2.5 mm ² (1 x 24 to 2 x 14 AWG)		For suitable female connector, see page 73.	1 x 0.2 to 2 x 2.5 mm ² (1 x 24 to 2 x 14 AWG)	
Weight, lb (kg)		1.55 (0.705)		1.62 (0.735)	7.72 (3.500)	
Supplementary specifications (not shown under general specifications)						
Possible differential (subtract from PH to get PB)	Min. at low setting	0.57 bar ±0.05 (8.26 psi ±0.72).			0.45 bar ±0.05 (6.52 psi ±0.72).	
	Min. at high setting	0.85 bar, -0.1, +0.15 (12.32 psi, -1.45, +2.17)			0.85 bar, -0.1, +0.15 (12.32 psi, -1.45, +2.17)	
	Max. at high setting	7.5 bar (108.75 psi)			6.25 bar (90.62 psi)	
Maximum allowable pressure	Per cycle	12.5 bar (181.25 psi)			30 bar (435 psi)	
	Accidental	22.5 bar (326.25 psi)			37.5 bar (543.75 psi)	
Destruction pressure		45 bar (652.5 psi)			67.5 bar (978.75 psi)	
Pressure switch style		Diaphragm				

<p>Operating curves</p>	<p>Connection</p> <p>Terminal model</p> <p>Connector model</p> <p>Pressure switch connector pin view</p> <p>1 → 11 and 13 2 → 12 3 → 14</p>
--------------------------------	---

Other versions For switches with alternative tapped cable entries, consult the Customer Care Center.

Size 10 bar (145 psi)
Adjustable differential, for regulation between two thresholds
2 C/O single-pole contacts

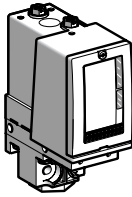
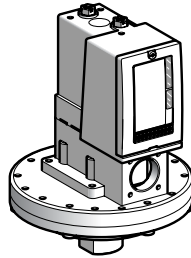
XMLC pressure switches	With setting scale	With setting scale overpressure 30 bar (435 psi)
		

Adjustable range of operating point (PH) (rising pressure)	0.7–10 bar (10.15–145 psi)
--	----------------------------

Catalog numbers

Fluids controlled For materials in contact with fluid, see page 77.	Hydraulic oils, fresh water, air, up to 158 °F (70 °C)	—	—	XMLCS10A2S13	XMLCS10A2S11
	Hydraulic oils, fresh water, sea water, air, up to 320 °F (160 °C)	XMLC010B2S13	XMLC010B2S11	—	—
	Corrosive fluids, up to 320 °F (160 °C)	XMLC010C2S13	XMLC010C2S11	—	—

Pressure connection	1/4"-18 NPTF	G 1/4-19	1/4"-18 NPTF	G 1/4-19
----------------------------	--------------	----------	--------------	----------

Electrical connection	Conduit/cable entry	1/2" NPT	Pg 13.5	1/2" NPT	Pg 13.5
	Terminals	1 x 0.2 to 2 x 2.5 mm ² (1 x 24 to 2 x 14 AWG)			

Weight, lb (kg)	1.51 (0.685)	7.72 (3.500)
------------------------	--------------	--------------

Supplementary specifications (not shown under general specifications)

Possible differential (subtract from PH to get PB)	Min. at low setting	0.45 bar ±0.05 (6.53 psi ±0.72)	0.25 bar ±0.05 (3.62 psi ±0.72)
	Min. at high setting	0.70 bar ±0.01 (10.15 psi ±1.45)	0.65 bar ±0.01 (9.42 psi ±1.45)
	Max. at high setting	8 bar (116 psi)	5.6 bar (81.2 psi)
Maximum allowable pressure	Per cycle	12.5 bar (181.25 psi)	30 bar (435 psi)
	Accidental	22.5 bar (326.25 psi)	37.5 bar (543.75 psi)
Destruction pressure		45 bar (652.5 psi)	67.5 bar (978.75 psi)

Pressure switch style	Diaphragm
------------------------------	-----------

Operating curves

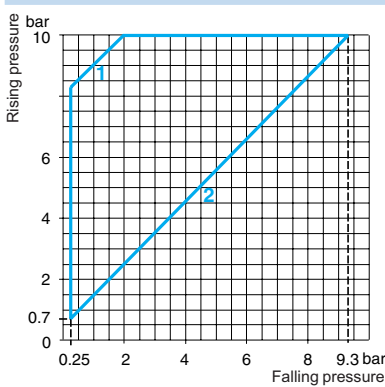

1 Maximum differential
 2 Minimum differential

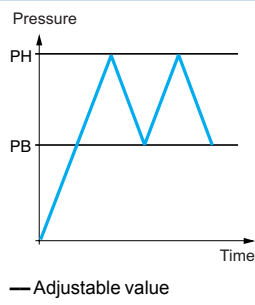

Connection

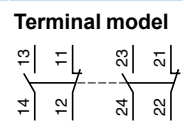

Other versions For switches with alternative tapped cable entries, consult the Customer Care Center.

Size 10 bar (145 psi)
Dual-stage, fixed differential, for detection at each threshold
2 C/O single-pole contacts (one per stage)

XMLD pressure switches Without setting scale

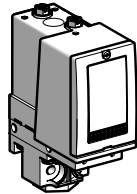

Adjustable range of each operating point (rising pressure)	2nd stage operating point (PH2)	1.2–10 bar (17.4–145 psi)
	1st stage operating point (PH1)	0.52–9.32 bar (7.54–135.14 psi)
Spread between the two stages (PH2–PH1)		0.68–5.8 bar (9.86–84.1 psi)

Catalog numbers

Fluids controlled For materials in contact with fluid, see page 77.	Hydraulic oils, fresh water, sea water, air, up to 320 °F (160 °C)	XMLD010B1S13	XMLD010B1S11
	Corrosive fluids, up to 320 °F (160 °C)	XMLD010C1S13	XMLD010C1S11
Pressure connection		1/4"-18 NPTF	G 1/4-19
Electrical connection	Conduit/cable entry	1/2" NPT	Pg 13.5
	Terminals	1 x 0.2 to 2 x 2.5 mm ² (1 x 24 to 2 x 14 AWG)	
Weight, lb (kg)	1.55 (0.705)		

Supplementary specifications (not shown under general specifications)

Inherent differential (subtract from PH1/PH2 to get PB1/PB2)	At low setting	0.45 bar ±0.05 (6.53 psi ±0.72)
	At high setting	0.6 bar, ±0.1 (8.7 psi ±1.45)
Maximum allowable pressure	Per cycle	12.5 bar (181.25 psi)
	Accidental	22.5 bar (326.25 psi)
Destruction pressure	45 bar (652.5 psi)	
Pressure switch style	Diaphragm	

Operating curves

High setting trip points of contacts 1 and 2

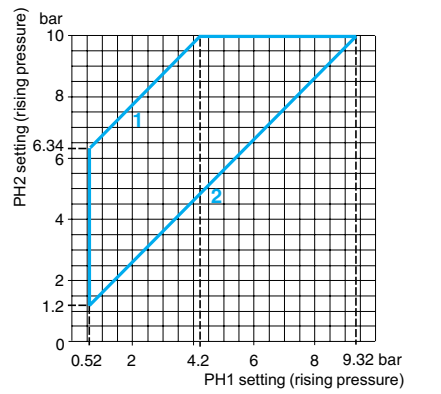

1 Maximum differential
 2 Minimum differential

Inherent differential of contacts 1 and 2

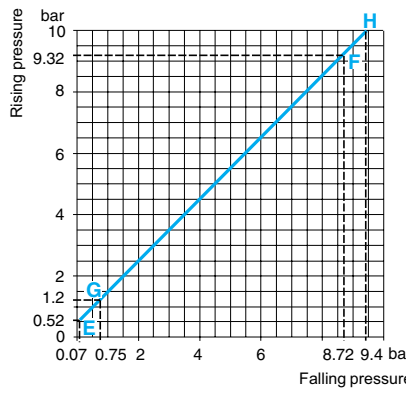

EF Contact 1 (stage 1)
 GH Contact 2 (stage 2)

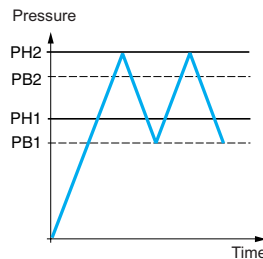

— Adjustable value
 --- Nonadjustable value

Connection

Terminal model

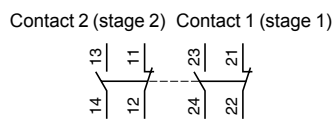

Other versions For switches with alternative tapped cable entries, consult the Customer Care Center.

Size 20 bar (290 psi)
Fixed differential, for detection of a single threshold
1 C/O single-pole contact

XMLA pressure switches **With setting scale**



Adjustable range of operating point (PH) (rising pressure) 1–20 bar (14.5–290 psi)

Catalog numbers

Fluids controlled For materials in contact with fluid, see page 77.	Hydraulic oils, fresh water, sea water, air, up to 158 °F (70 °C)	XMLA020A2S13	XMLA020A2S11	XMLA020A2C11
	Hydraulic oils, fresh water, sea water, air, up to 320 °F (160 °C)	XMLA020B2S13	XMLA020B2S11	XMLA020B2C11
	Corrosive fluids, up to 320 °F (160 °C)	XMLA020C2S13	XMLA020C2S11	XMLA020C2C11
	Viscous products, up to 320 °F (160 °C) (G1-1/4" pressure connection)	XMLA020P2S13	XMLA020P2S11	XMLA020P2C11

Pressure connection 1/4"-18 NPTF G 1/4-19 G 1/4-19

Electrical connection

Conduit/cable entry	1/2" NPT	Pg 13.5	DIN 43650A, 4-pin male
Terminals	1 x 0.2 to 2 x 2.5 mm ² (1 x 24 to 2 x 14 AWG)		For suitable female connector, see page 73.

Weight, lb (kg) 1.51 (0.685) 1.58 (0.715)

Supplementary specifications (not shown under general specifications)

Inherent differential (subtract from PH to get PB)

At low setting	0.4 bar ±0.2 (5.8 psi ±2.9)
At high setting	1 bar ±0.1 (14.5 psi ±1.45)

Maximum allowable pressure

Per cycle	25 bar (362.5 psi)
Accidental	45 bar (652.5 psi)

Destruction pressure 90 bar (1305 psi)

Pressure switch style Diaphragm

Operating curves **Connection**

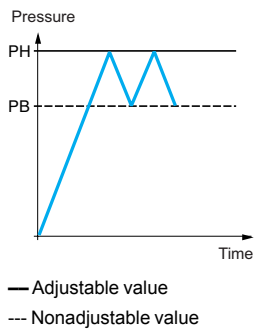
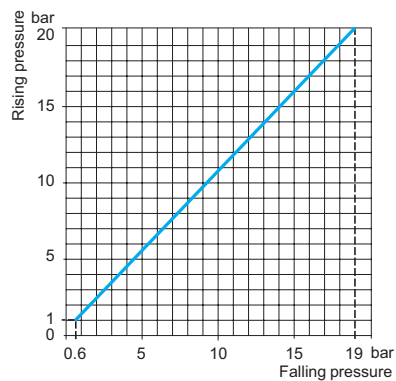

Terminal model

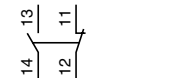

Connector model

Pressure switch connector pin view

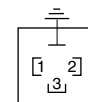

- 1 → 11 and 13
- 2 → 12
- 3 → 14

Other versions For switches with alternative tapped cable entries, consult the Customer Care Center.

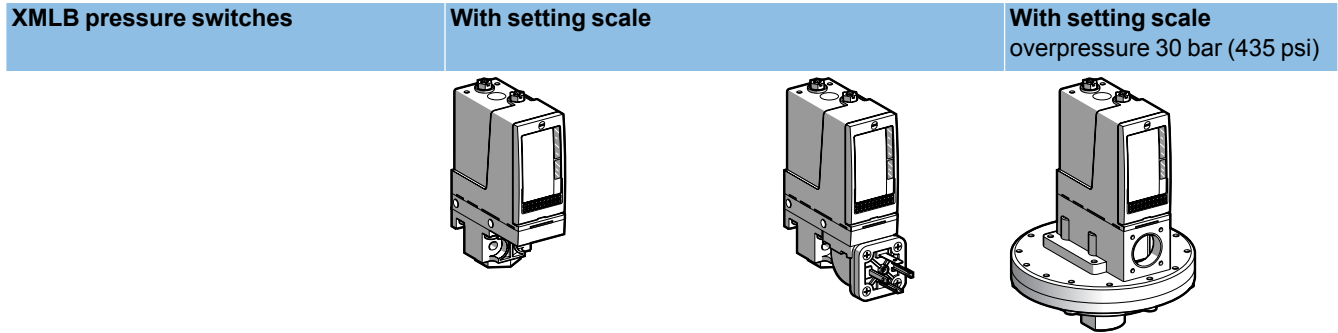

Size 20 bar (290 psi)
Adjustable differential, for regulation between two thresholds
1 C/O single-pole contact



Adjustable range of operating point (PH) (rising pressure) 1.3–20 bar (18.9–290 psi)

Catalog numbers						
Fluids controlled For materials in contact with fluid, see page 77.	Hydraulic oils, fresh water, sea water, air, up to 158 °F (70 °C)	XMLB020A2S13	XMLB020A2S11	XMLB020A2C11	—	—
	Hydraulic oils, fresh water, air, up to 320 °F (160 °C)	—	—	—	XMLBS20A2S13	XMLBS20A2S11
	Hydraulic oils, fresh water, air, up to 320 °F (160 °C)	XMLB020B2S13	XMLB020B2S11	XMLB020B2C11	—	—
	Corrosive fluids, up to 320 °F (160 °C)	XMLB020C2S13	XMLB020C2S11	XMLB020C2C11	—	—
	Viscous products, up to 320 °F (160 °C) (G1-1/4" pressure connection)	XMLB020P2S13	XMLB020P2S11	XMLB020P2C11	—	—
Pressure connection		1/4"-18 NPTF	G 1/4-19	G 1/4-19	1/4"-18 NPTF	G 1/4-19
Electrical connection	Conduit/cable entry	1/2" NPT	Pg 13.5	DIN 43650A, 4-pin male	1/2" NPT	Pg 13.5
	Terminals	1 x 0.2 to 2 x 2.5 mm ² (1 x 24 to 2 x 14 AWG)		For suitable female connector, see page 73.	1 x 0.2 to 2 x 2.5 mm ² (1 x 24 to 2 x 14 AWG)	
Weight, lb (kg)		1.55 (0.705)	1.62 (0.735)	1.62 (0.735)	7.72 (3.500)	7.72 (3.500)

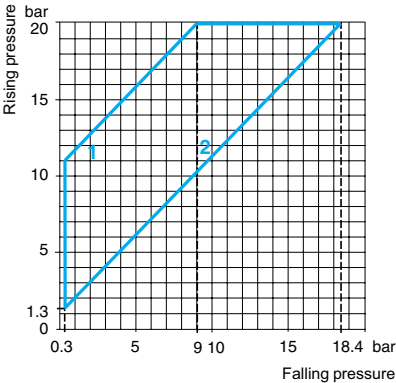
Supplementary specifications (not shown under general specifications)			
Possible differential (subtract from PH to get PB)	Min. at low setting	1 bar ±0.25 (14.5 psi ±3.63)	0.95 bar ±0.25 (13.78 psi ±3.63)
	Min. at high setting	1.6 bar ±0.25 (23.20 psi ±3.63)	1.45 bar ±0.25 (21.03 psi ±3.63)
	Max. at high setting	11 bar (159.5 psi)	12.6 bar (182.7 psi)
Maximum allowable pressure	Per cycle	25 bar (362.5 psi)	30 bar (435 psi)
	Accidental	45 bar (652.5 psi)	37.5 bar (543.75 psi)
Destruction pressure		90 bar (1305 psi)	67.5 bar (978.75 psi)
Pressure switch style		Diaphragm	

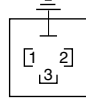
Operating curves	Connection
 <p>1 Maximum differential 2 Minimum differential</p>	<p>Terminal model</p>  <p>Connector model Pressure switch connector pin view</p>  <p>1 → 11 and 13 2 → 12 3 → 14</p>

Other versions For switches with alternative tapped cable entries, consult the Customer Care Center.

Size 20 bar (290 psi)
Adjustable differential, for regulation between two thresholds
2 C/O single-pole contacts

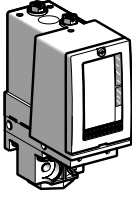
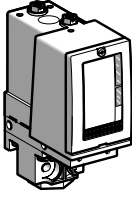
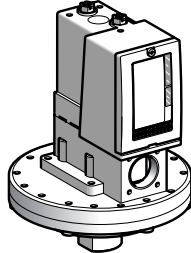
XMLC pressure switches	With setting scale	With setting scale 30 bar (435 psi) overpressure
		

Adjustable range of operating point (PH) (rising pressure)	1.3–20 bar (18.85–290 psi)
--	----------------------------

Catalog numbers

Fluids controlled For materials in contact with fluid, see page 77.	Hydraulic oils, fresh water, air, up to 158 °F (70 °C)	—	—	XMLCS20A2S13	XMLCS20A2S11
	Hydraulic oils, fresh water, sea water, air, up to 320 °F (160 °C)	XMLC020B2S13	XMLC020B2S11	—	—
	Corrosive fluids, up to 320 °F (160 °C)	XMLC020C2S13	XMLC020C2S11	—	—
Pressure connection		1/4"-18 NPTF	G 1/4-19	1/4"-18 NPTF	G 1/4-19
Electrical connection	Conduit/cable entry	1/2" NPT	Pg 13.5	1/2" NPT	Pg 13.5
	Terminals	1 x 0.2 to 2 x 2.5 mm ² (1 x 24 to 2 x 14 AWG)			
Weight, lb (kg)	1.51 (0.685)			7.72 (3.500)	

Supplementary specifications (not shown under general specifications)

Possible differential (subtract from PH to get PB)	Min. at low setting	0.7 bar ±0.2 (10.15 psi ±2.9)	0.7 bar ±0.2 (10.15 psi ±2.9)
	Min. at high setting	1 bar ±0.2 (14.5 psi ±2.9)	1.15 bar ±0.2 (16.67 psi ±2.9)
	Max. at high setting	11 bar (159.5 psi)	11.70 bar (169.6 psi)
Maximum allowable pressure	Per cycle	25 bar (362.5 psi)	30 bar (435 psi)
	Accidental	45 bar (652.5 psi)	37.5 bar (543.75 psi)
Destruction pressure		90 bar (1305 psi)	67.5 bar (978.75 psi)
Pressure switch style		Diaphragm	

Operating curves

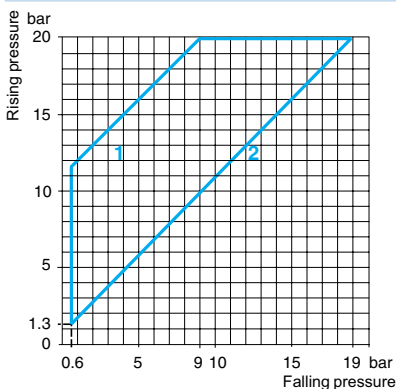

1 Maximum differential
 2 Minimum differential

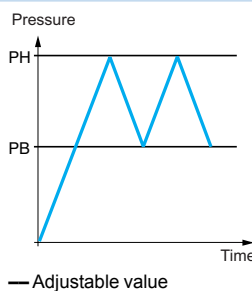

Connection

Terminal model

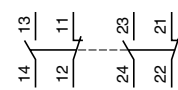

Other versions For switches with alternative tapped cable entries, consult the Customer Care Center.

Size 20 bar (290 psi)
Dual-stage, fixed differential, for detection at each threshold
2 C/O single-pole contacts (one per stage)

XMLD pressure switches Without setting scale

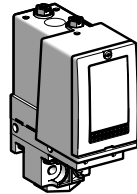

Adjustable range of each operating point (rising pressure)	2nd stage operating point (PH2)	2.14–20 bar (31.03–290 psi)
	1st stage operating point (PH1)	0.9–18.76 bar (13.05–272.02 psi)
Spread between the two stages (PH2–PH1)		1.24–9.55 bar (17.98–138.48 psi)
Catalog numbers		
Fluids controlled For materials in contact with fluid, see page 77.	Hydraulic oils, fresh water, sea water, air, up to 320 °F (160 °C)	XMLD020B1S13
	Corrosive fluids, up to 320 °F (160 °C)	XMLD020C1S13
Pressure connection		1/4"-18 NPTF
Electrical connection	Conduit/cable entry	1/2" NPT
	Terminals	1 x 0.2 to 2 x 2.5 mm ² (1 x 24 to 2 x 14 AWG)
Weight, lb (kg)		1.55 (0.705)
Supplementary specifications (not shown under general specifications)		
Inherent differential (subtract from PH1/PH2 to get PB1/PB2)	At low setting	0.7 bar ±0.15 (10.15 psi ±2.18)
	At high setting	1.3 bar ±0.3 (18.85 psi ±4.35)
Maximum allowable pressure	Per cycle	25 bar (362.5 psi)
	Accidental	45 bar (652.5 psi)
Destruction pressure		90 bar (1305 psi)
Pressure switch style		Diaphragm

Operating curves

High setting trip points of contacts 1 and 2

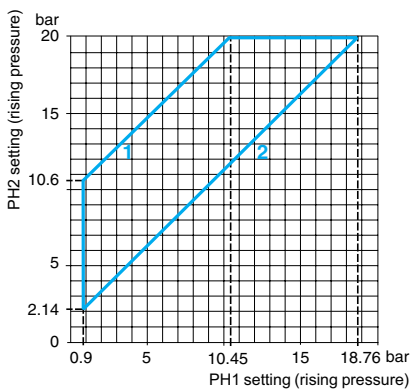

1 Maximum differential
 2 Minimum differential

Inherent differential of contacts 1 and 2

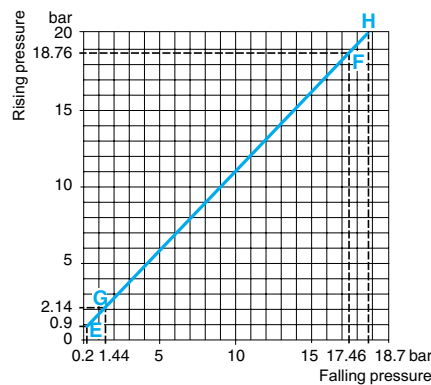

EF Contact 1 (stage 1)
 GH Contact 2 (stage 2)

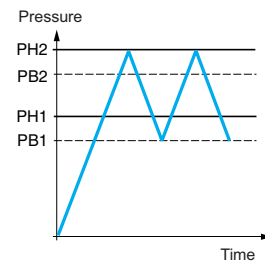

— Adjustable value
 --- Nonadjustable value

Connection

Terminal model
 Contact 2 (stage 2) Contact 1 (stage 1)

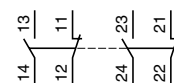

Other versions For switches with alternative tapped cable entries, consult the Customer Care Center.

Size 35 bar (507.5 psi)
Fixed differential, for detection of a single threshold
1 C/O single-pole contact

XMLA pressure switches **With setting scale**

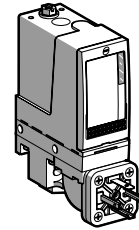
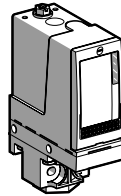

Adjustable range of operating point (PH) (rising pressure)	1.5–35 bar (21.75–507.5 psi)
--	------------------------------

Catalog numbers

Fluids controlled For materials in contact with fluid, see page 77.	Hydraulic oils, fresh water, sea water, air, up to 158 °F (70 °C)	XMLA035A2S13	XMLA035A2S11	XMLA035A2C11
	Hydraulic oils, fresh water, sea water, air, up to 320 °F (160 °C)	XMLA035B2S13	XMLA035B2S11	XMLA035B2C11
	Corrosive fluids, up to 320 °F (160 °C)	XMLA035C2S13	XMLA035C2S11	XMLA035C2C11
	Viscous products, up to 320 °F (160 °C) (G1-1/4" pressure connection)	XMLA035P2S13	XMLA035P2S11	XMLA035P2C11

Pressure connection	1/4"-18 NPTF	G 1/4-19	G 1/4-19
----------------------------	--------------	----------	----------

Electrical connection	Conduit/cable entry	1/2" NPT	Pg 13.5	DIN 43650A, 4-pin male
	Terminals	1 x 0.2 to 2 x 2.5 mm ² (1 x 24 to 2 x 14 AWG)		For suitable female connector, see page 73.

Weight, lb (kg)	1.53 (0.695)	1.60 (0.725)
------------------------	--------------	--------------

Supplementary specifications (not shown under general specifications)

Inherent differential (subtract from PH to get PB)	At low setting	1.25 bar ±0.25 (18.12 psi ±3.62)
	At high setting	1.25 bar ±0.25 (18.12 psi ±3.62)

Maximum allowable Pressure	Per cycle	45 bar (652.5 psi)
	Accidental	80 bar (1160 psi)

Destruction pressure	160 bar (2320 psi)
-----------------------------	--------------------

Pressure switch style	Diaphragm
------------------------------	-----------

Operating curves **Connection**

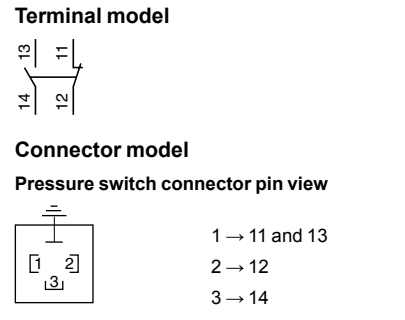
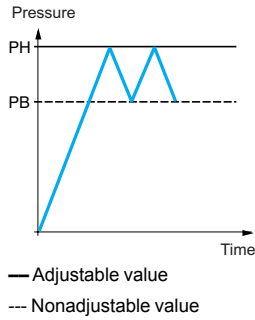
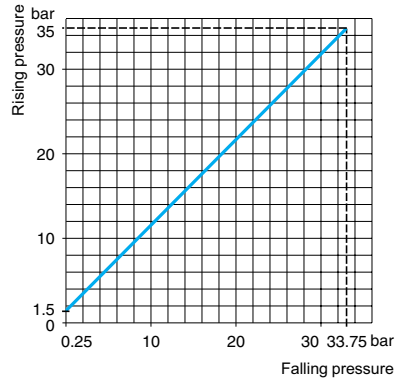

Other versions For switches with alternative tapped cable entries, consult the Customer Care Center.

Size 35 bar (507.5 psi)
Adjustable differential, for regulation between two thresholds
1 C/O single-pole contact

XMLB pressure switches **With setting scale**

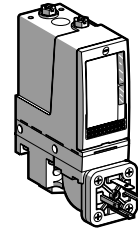
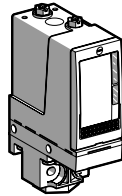

Adjustable range of operating point (PH)
 (rising pressure) 3.5–35 bar (50.75–507.5 psi)

Catalog numbers

Fluids controlled For materials in contact with fluid, see page 77.	Hydraulic oils, fresh water, sea water, air, up to 158 °F (70 °C)	XMLB035A2S13	XMLB035A2S11	XMLB035A2C11
	Hydraulic oils, fresh water, sea water, air, up to 320 °F (160 °C)	XMLB035B2S13	XMLB035B2S11	XMLB035B2C11
	Corrosive fluids, up to 320 °F (160 °C)	XMLB035C2S13	XMLB035C2S11	XMLB035C2C11
	Viscous products, up to 320 °F (160 °C) (G1-1/4" pressure connection)	XMLB035P2S13	XMLB035P2S11	XMLB035P2C11

Pressure connection 1/4"-18 NPTF G 1/4-19 G 1/4-19

Electrical connection

Conduit/cable entry	1/2" NPT	Pg 13.5	DIN 43650A, 4-pin male
Terminals	1 x 0.2 to 2 x 2.5 mm ² (1 x 24 to 2 x 14 AWG)		For suitable female connector, see page 73.

Weight, lb (kg) 1.58 (0.715) 1.64 (0.745)

Supplementary specifications (not shown under general specifications)

Possible differential (subtract from PH to get PB)	Min. at low setting	1.7 bar, -0.5, +0.7 (24.65 psi, -7.25, +10.15)
	Min. at high setting	2.55 bar, -0.5, +0.7 (36.97 psi, -7.25, +10.15)
	Max. at high setting	20 bar (290 psi)
Maximum allowable pressure	Per cycle	45 bar (652.5 psi)
	Accidental	80 bar (1160 psi)
Destruction pressure		160 bar (2320 psi)
Pressure switch style		Diaphragm

Operating curves **Connection**

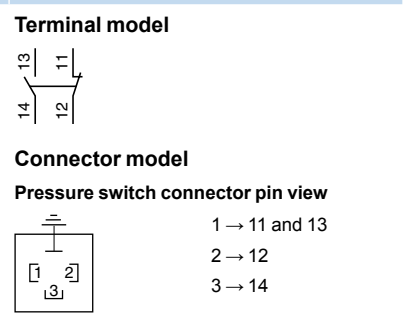
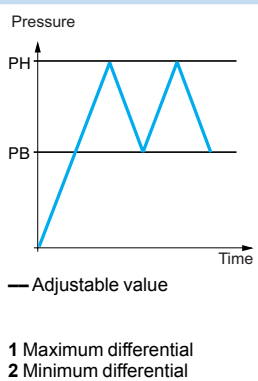
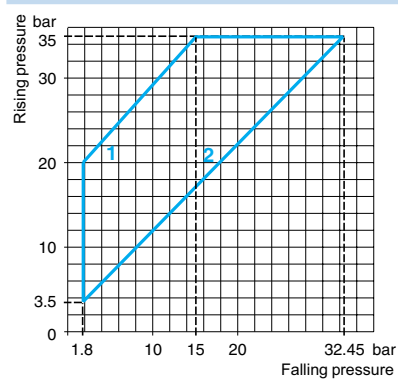

Other versions For switches with alternative tapped cable entries, consult the Customer Care Center.

Size 35 bar (507.5 psi)
Adjustable differential, for regulation between two thresholds
2 C/O single-pole contacts

XMLC pressure switches **With setting scale**

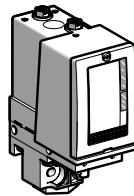

Adjustable range of operating point (PH)
 (rising pressure) 3.5–35 bar (50.75–507.5 psi)

Catalog numbers

Fluids controlled For materials in contact with fluid, see page 77.	Hydraulic oils, fresh water, sea water, air, up to 320 °F (160 °C)	XMLC035B2S13	XMLC035B2S11
	Corrosive fluids, up to 320 °F (160 °C)	XMLC035C2S13	XMLC035C2S11

Pressure connection 1/4"-18 NPTF G 1/4-19

Electrical connection

Conduit/cable entry	1/2" NPT	Pg 13.5
Terminals	1 x 0.2 to 2 x 2.5 mm ² (1 x 24 to 2 x 14 AWG)	

Weight, lb (kg) 1.53 (0.695)

Supplementary specifications (not shown under general specifications)

Possible differential (subtract from PH to get PB)	Min. at low setting	1 bar ±0.2 (14.5 psi ±2.9)
	Min. at high setting	1.5 bar ±0.5 (21.75 psi ±7.25)
	Max. at high setting	22 bar (319 psi)
Maximum allowable pressure	Per cycle	45 bar (652.5 psi)
	Accidental	80 bar (1160 psi)
Destruction pressure	160 bar (2320 psi)	
Pressure switch style	Diaphragm	

Operating curves **Connection**

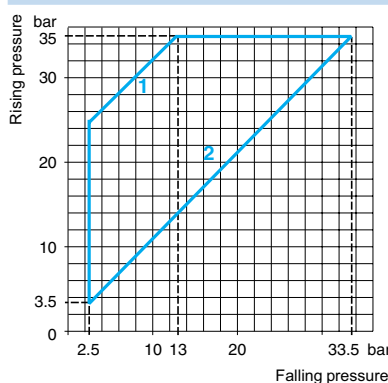

1 Maximum differential
 2 Minimum differential

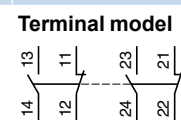
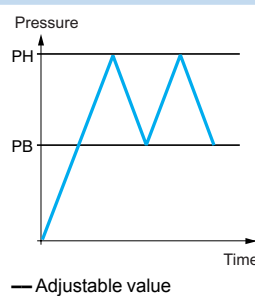

Other versions For switches with alternative tapped cable entries, consult the Customer Care Center.

Size 35 bar (507.5 psi)
Dual-stage, fixed differential, for detection at each threshold
2 C/O single-pole contacts (one per stage)

XMLD pressure switches Without setting scale

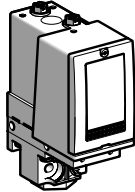

Adjustable range of each operating point (rising pressure)	2nd stage operating point (PH2) 1st stage operating point (PH1)	4.4–35 bar (63.8–507.5 psi) 1.9–32.5 bar (27.55–471.25 psi)
Spread between the two stages (PH2–PH1)		2.5–20.4 bar (36.25–295.8 psi)
Catalog numbers		
Fluids controlled For materials in contact with fluid, see page 77.	Hydraulic oils, fresh water, sea water, air, up to 320 °F (160 °C)	XMLD035B1S13
	Corrosive fluids, up to 320 °F (160 °C)	XMLD035C1S13
Pressure connection		1/4"-18 NPTF
Electrical connection	Conduit/cable entry	1/2" NPT
	Terminals	1 x 0.2 to 2 x 2.5 mm ² (1 x 24 to 2 x 14 AWG)
Weight, lb (kg)		1.58 (0.715)
Supplementary specifications (not shown under general specifications)		
Inherent differential (subtract from PH1/PH2 to get PB1/PB2)	At low setting	1.5 bar ±0.3 (21.75 psi ±4.35)
	At high setting	2.6 bar ±0.7 (37.7 psi ±10.15)
Maximum allowable pressure	Per cycle	45 bar (652.5 psi)
	Accidental	80 bar (1160 psi)
Destruction pressure		160 bar (2320 psi)
Pressure switch style		Diaphragm

Operating curves

High setting trip points of contacts 1 and 2

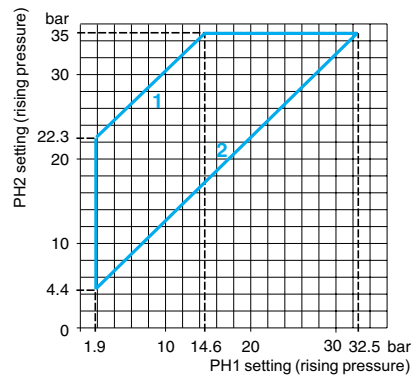

- 1 Maximum differential
- 2 Minimum differential

Inherent differential of contacts 1 and 2

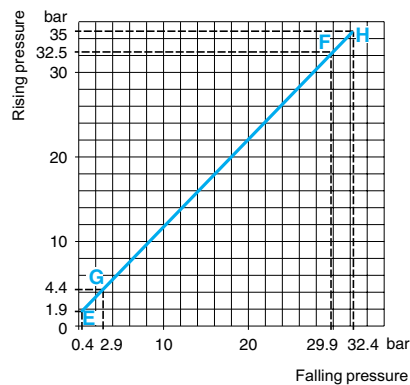

- EF Contact 1 (stage 1)
- GH Contact 2 (stage 2)

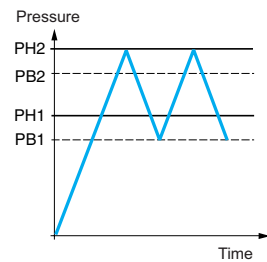

- Adjustable value
- Nonadjustable value

Connection

Terminal model

Contact 2 (stage 2) Contact 1 (stage 1)

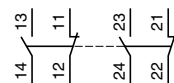

Other versions For switches with alternative tapped cable entries, consult the Customer Care Center.

Size 70 bar (1015 psi)
Fixed differential, for detection of a single threshold
1 C/O single-pole contact

XMLA pressure switches **With setting scale**

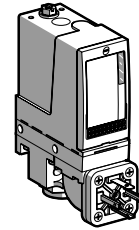
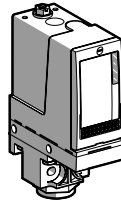

Adjustable range of operating point (PH) (rising pressure) 5–70 bar (72.5–1015 psi)

Catalog numbers

Fluids controlled For materials in contact with fluid, see page 77.	Hydraulic oils, up to 320 °F (160 °C)	XMLA070D2S13	XMLA070D2S11	XMLA070D2C11
	Fresh water, sea water, up to 320 °F (160 °C)	XMLA070E2S13	XMLA070E2S11	XMLA070E2C11
	Corrosive fluids, air, up to 320 °F (160 °C)	XMLA070N2S13	XMLA070N2S11	XMLA070N2C11
Pressure connection		1/4"-18 NPTF	G 1/4-19	G 1/4-19
Electrical connection	Conduit/cable entry	1/2" NPT	Pg 13.5	DIN 43650A, 4-pin male
	Terminals	1 x 0.2 to 2 x 2.5 mm ² (1 x 24 to 2 x 14 AWG)		For suitable female connector, see page 73.
Weight, lb (kg)		1.53 (0.695)	1.60 (0.725)	

Supplementary specifications (not shown under general specifications)

Inherent differential (subtract from PH to get PB)	At low setting	3 bar ±1 (43.5 psi ±14.5)
	At high setting	7.5 bar ±1 (108.75 psi ±14.5)
Maximum allowable pressure	Per cycle	90 bar (1035 psi)
	Accidental	160 bar (2320 psi)
Destruction pressure		320 bar (4640 psi)
Pressure switch style		Piston

Operating curves **Connection**

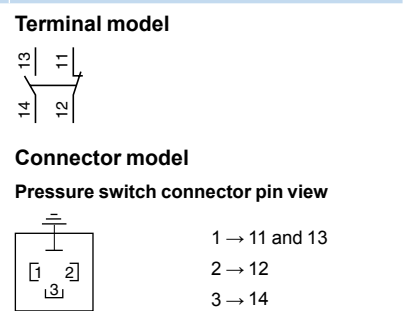
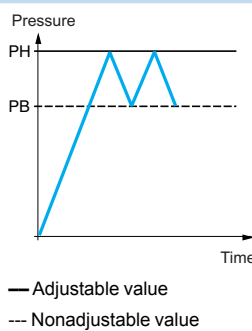
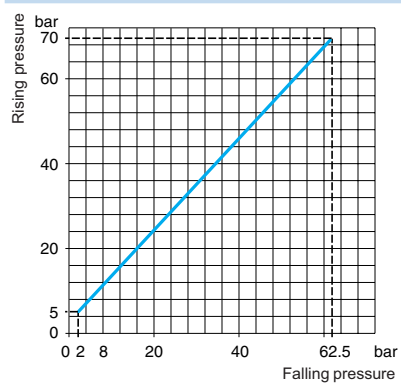

Other versions For switches with alternative tapped cable entries, consult the Customer Care Center.

Size 70 bar (1015 psi)
Adjustable differential, for regulation between two thresholds
1 C/O single-pole contact

XMLB pressure switches **With setting scale**



Adjustable range of operating point (PH) (rising pressure) 7–70 bar (101.5–1015 psi)

Catalog numbers

Fluids controlled For materials in contact with fluid, see page 77.	Hydraulic oils, up to 320 °F (160 °C)	XMLB070D2S13	XMLB070D2S11	XMLB070D2C11
	Fresh water, sea water, up to 320 °F (160 °C)	XMLB070E2S13	XMLB070E2S11	XMLB070E2C11
	Corrosive fluids, air, up to 320 °F (160 °C)	XMLB070N2S13	XMLB070N2S11	XMLB070N2C11
Pressure connection		1/4"-18 NPTF	G 1/4-19	G 1/4-19
Electrical connection	Conduit/cable entry	1/2" NPT	Pg 13.5	DIN 43650A, 4-pin male
	Terminals	1 x 0.2 to 2 x 2.5 mm ² (1 x 24 to 2 x 14 AWG)		For suitable female connector, see page 73.
Weight, lb (kg)		1.58 (0.715)		1.64 (0.745)

Supplementary specifications (not shown under general specifications)

Possible differential (subtract from PH to get PB)	Min. at low setting	4.7 bar, -0.4, +0.7 (68.15 psi, -5.8, +10.15)
	Min. at high setting	8.8 bar, -0.6, +0.8 (127.6 psi, -8.7, +11.6)
	Max. at high setting	50 bar (725 psi)
Maximum allowable pressure	Per cycle	90 bar (1035 psi)
	Accidental	160 bar (2320 psi)
Destruction pressure		320 bar (4640 psi)
Pressure switch style		Piston

Operating curves **Connection**

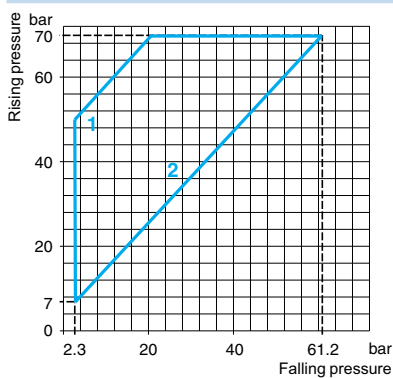

1 Maximum differential
2 Minimum differential

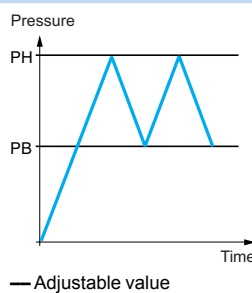

Terminal model



Connector model

Pressure switch connector pin view

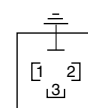

1 → 11 and 13
 2 → 12
 3 → 14

Other versions For switches with alternative tapped cable entries, consult the Customer Care Center.

Size 70 bar (1015 psi)
Adjustable differential, for regulation between two thresholds
2 C/O single-pole contacts

XMLC pressure switches **With setting scale**

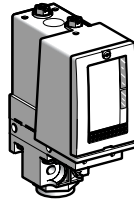

Adjustable range of operating point (PH)
 (rising pressure) 7–70 bar (101.5–1015 psi)

Electrical connection Terminals

Catalog numbers

Fluids controlled For materials in contact with fluid, see page 77.	Hydraulic oils, up to 320 °F (160 °C)	XMLC070D2S13	XMLC070D2S11
	Fresh water, sea water, up to 320 °F (160 °C)	XMLC070E2S13	XMLC070E2S11
	Corrosive fluids, up to 320 °F (160 °C)	XMLC070N2S13	XMLC070N2S11

Pressure connection 1/4"-18 NPTF G 1/4-19

Electrical connection

Conduit/cable entry	1/2" NPT	Pg 13.5
Terminals	1 x 0.2 to 2 x 2.5 mm ² (1 x 24 to 2 x 14 AWG)	

Weight, lb (kg) 1.53 (0.695)

Supplementary specifications (not shown under general specifications)

Possible differential (subtract from PH to get PB)	Min. at low setting	4.5 bar ±0.8 (65.25 psi ±11.6)
	Min. at high setting	8.9 bar ±0.8 (129.05 psi ±11.6)
	Max. at high setting	60 bar (870 psi)
Maximum allowable pressure	Per cycle	90 bar (1035 psi)
	Accidental	160 bar (2320 psi)
Destruction pressure		320 bar (4640 psi)

Pressure switch style Piston

Operating curves **Connection**

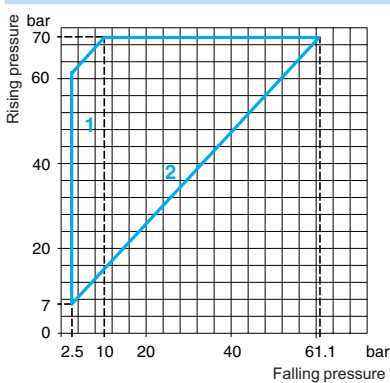

1 Maximum differential
2 Minimum differential

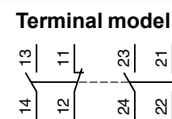
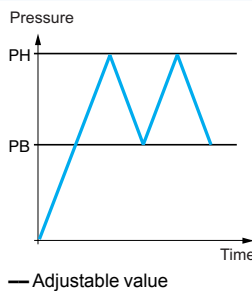

Other versions For switches with alternative tapped cable entries, consult the Customer Care Center.

Size 70 bar (1015 psi)
Dual-stage, fixed differential, for detection at each threshold
2 C/O single-pole contacts (one per stage)

XMLD pressure switches Without setting scale

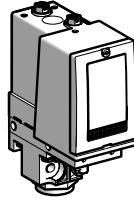

Adjustable range of each operating point (rising pressure)	2nd stage operating point (PH2)	9.4–70 bar (136.3–1015 psi)
	1st stage operating point (PH1)	6.6–67.2 bar (95.7–974.4 psi)
Spread between the two stages (PH2–PH1)		2.8–46 bar (40.6–667 psi)

Catalog numbers

Fluids controlled For materials in contact with fluid, see page 77.	Hydraulic oils, up to 320 °F (160 °C)	XMLD070D1S13	XMLD070D1S11
	Fresh water, sea water, up to 320 °F (160 °C)	XMLD070E1S13	XMLD070E1S11
	Corrosive fluids, air, up to 320 °F (160 °C)	XMLD070N1S13	XMLD070N1S11

Pressure connection		1/4"-18 NPTF	G 1/4-19
Electrical connection	Conduit/cable entry	1/2" NPT	Pg 13.5
	Terminals	1 x 0.2 to 2 x 2.5 mm ² (1 x 24 to 2 x 14 AWG)	

Weight, lb (kg)	1.58 (0.715)
------------------------	--------------

Supplementary specifications (not shown under general specifications)

Inherent differential (subtract from PH1/PH2 to get PB1/PB2)	At low setting	5 bar ±1.5 (72.5 psi ±21.75)
	At high setting	9.5 bar ±2 (137.75 psi ±29)
Maximum allowable pressure	Per cycle	90 bar (1035 psi)
	Accidental	160 bar (2320 psi)
Destruction pressure		320 bar (4640 psi)
Pressure switch style		Piston

Operating curves

High setting trip points of contacts 1 and 2

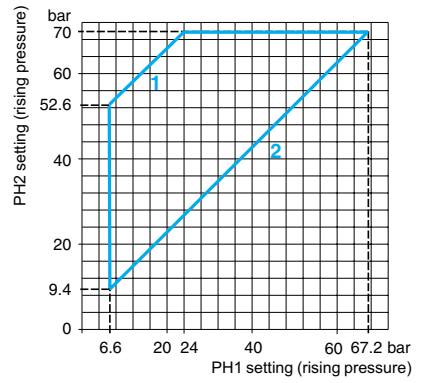

- 1 Maximum differential
- 2 Minimum differential

Inherent differential of contacts 1 and 2

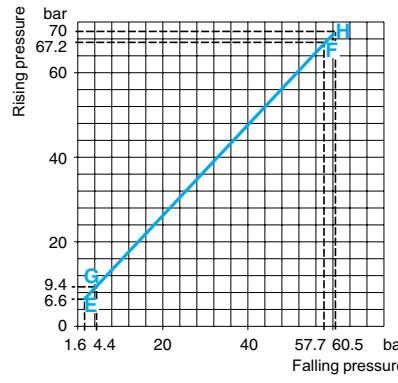

- EF Contact 1 (stage 1)
- GH Contact 2 (stage 2)

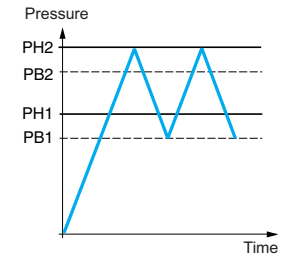

- Adjustable value
- Nonadjustable value

Connection

Terminal model

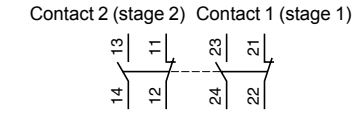

Other versions For switches with alternative tapped cable entries, consult the Customer Care Center.

Size 160 bar (2320 psi)
Fixed differential, for detection of a single threshold
1 C/O single-pole contact

XMLA pressure switches **With setting scale**

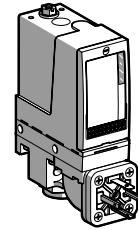
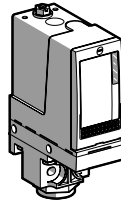

Adjustable range of operating point (PH) (rising pressure)	10–160 bar (145–2320 psi)
--	---------------------------

Catalog numbers

Fluids controlled For materials in contact with fluid, see page 77.	Hydraulic oils, up to 320 °F (160 °C)	XMLA160D2S13	XMLA160D2S11	XMLA160D2C11
	Fresh water, sea water, up to 320 °F (160 °C)	XMLA160E2S13	XMLA160E2S11	XMLA160E2C11
	Corrosive fluids, air, up to 320 °F (160 °C)	XMLA160N2S13	XMLA160N2S11	XMLA160N2C11

Pressure connection	1/4"-18 NPTF	G 1/4-19	G 1/4-19
----------------------------	--------------	----------	----------

Electrical connection	Conduit/cable entry	1/2" NPT	Pg 13.5	DIN 43650A, 4-pin male.
	Terminals	1 x 0.2 to 2 x 2.5 mm ² (1 x 24 to 2 x 14 AWG)		For suitable female connector, see page 73.

Weight, lb (kg)	1.65 (0.750)	1.72 (0.780)
------------------------	--------------	--------------

Supplementary specifications (not shown under general specifications)

Inherent differential (subtract from PH to get PB)	At low setting	5.5 bar ±1 (79.75 psi ±14.5)
	At high setting	18 bar ±3 (261 psi ±43.5)
Maximum allowable pressure	Per cycle	200 bar (2900 psi)
	Accidental	360 bar (5220 psi)
Destruction pressure	720 bar (10,440 psi)	
Mechanical life (depending on the application)	6 x 10 ⁶ operating cycles	

Pressure switch style	Piston
------------------------------	--------

Operating curves **Connection**

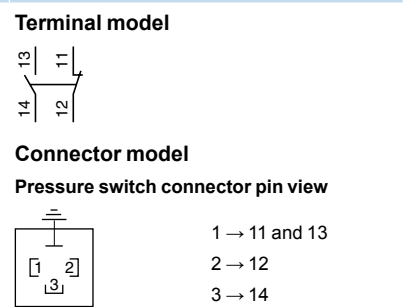
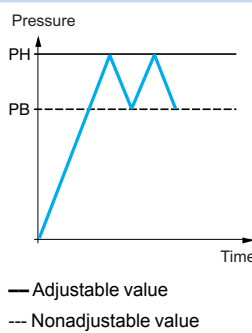
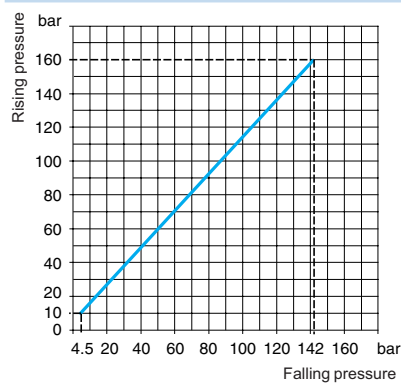

Other versions For switches with alternative tapped cable entries, consult the Customer Care Center.

Size 160 bar (2320 psi)
Adjustable differential, for regulation between two thresholds
1 C/O single-pole contact

XMLB pressure switches **With setting scale**

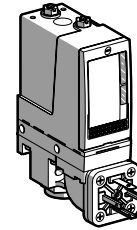
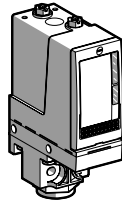

Adjustable range of operating point (PH) (rising pressure)	10–160 bar (145–2320 psi)
--	---------------------------

Catalog numbers

Fluids controlled For materials in contact with fluid, see page 77.	Hydraulic oils, up to 320 °F (160 °C)	XMLB160D2S13	XMLB160D2S11	XMLB160D2C11
	Fresh water, sea water, up to 320 °F (160 °C)	XMLB160E2S13	XMLB160E2S11	XMLB160E2C11
	Corrosive fluids, air, up to 320 °F (160 °C)	XMLB160N2S13	XMLB160N2S11	XMLB160N2C11

Pressure connection	1/4"-18 NPTF	G 1/4-19	G 1/4-19
----------------------------	--------------	----------	----------

Electrical connection	Conduit/cable entry	1/2" NPT	Pg 13.5	DIN 43650A, 4-pin male.
	Terminals	1 x 0.2 to 2 x 2.5 mm ² (1 x 24 to 2 x 14 AWG)		For suitable female connector, see page 73.

Weight, lb (kg)	1.65 (0.750)	1.72 (0.780)
------------------------	--------------	--------------

Supplementary specifications (not shown under general specifications)

Possible differential (subtract from PH to get PB)	Min. at low setting	9.3 bar, -1.8, +1.5 (134.85 psi, -26.1, +21.75)
	Min. at high setting	20.8 bar, -1.9, +1.6 (301.6 psi, -27.55, +23.2)
	Max. at high setting	100 bar (1450 psi)
Maximum allowable pressure	Per cycle	200 bar (2900 psi)
	Accidental	360 bar (5220 psi)
Destruction pressure	720 bar (10,440 psi)	
Pressure switch style	Piston	

Operating curves

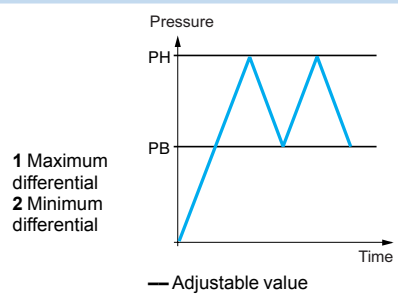
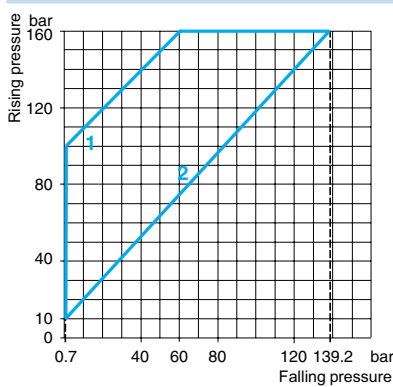

1 Maximum differential
 2 Minimum differential

Connection

Terminal model



Connector model

Pressure switch connector pin view

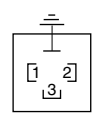

- 1 → 11 and 13
- 2 → 12
- 3 → 14

Other versions For switches with alternative tapped cable entries, consult the Customer Care Center.

Size 160 bar (2320 psi)
Adjustable differential, for regulation between two thresholds
2 C/O single-pole contacts

XMLC pressure switches **With setting scale**

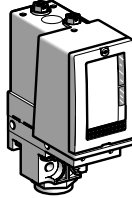

Adjustable range of operating point (PH) (rising pressure)	12–160 bar (174–2320 psi)
--	---------------------------

Catalog numbers

Fluids controlled For materials in contact with fluid, see page 77.	Hydraulic oils, up to 320 °F (160 °C)	XMLC160D2S13	XMLC160D2S11
	Fresh water, sea water, up to 320 °F (160 °C)	XMLC160E2S13	XMLC160E2S11
	Corrosive fluids, up to 320 °F (160 °C)	XMLC160N2S13	XMLC160N2S11
Pressure connection		1/4"-18 NPTF	G 1/4-19
Electrical connection	Conduit/cable entry	1/2" NPT	Pg 13.5
	Terminals	1 x 0.2 to 2 x 2.5 mm ² (1 x 24 to 2 x 14 AWG)	
Weight, lb (kg)	1.65 (0.750)		

Supplementary specifications (not shown under general specifications)

Possible differential (subtract from PH to get PB)	Min. at low setting	9 bar ±0.9 (130.5 psi ±13.05)
	Min. at high setting	21 bar ±0.9 (304.5 psi ±13.05)
	Max. at high setting	110 bar (1590 psi)
Maximum allowable pressure	Per cycle	200 bar (2900 psi)
	Accidental	360 bar (5220 psi)
Destruction pressure	720 bar (10,440 psi)	
Mechanical life (depending on the application)	6 x 10 ⁶ operating cycles	
Pressure switch style	Piston	

Operating curves **Connection**

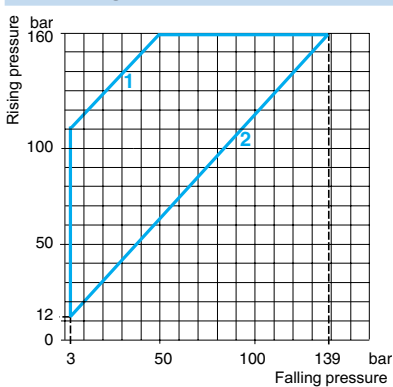

1 Maximum differential
 2 Minimum differential

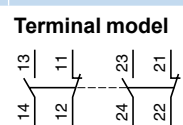
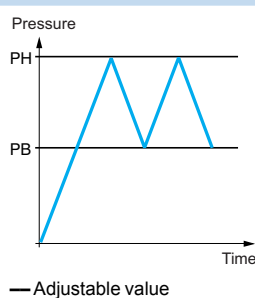

Other versions For switches with alternative tapped cable entries, consult the Customer Care Center.

Size 160 bar (2320 psi)
Dual-stage, fixed differential, for detection at each threshold
2 C/O single-pole contacts (one per stage)

XMLD pressure switches Without setting scale

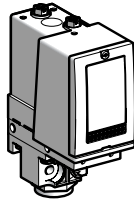

Adjustable range of each operating point (rising pressure)	2nd stage operating point (PH2)	16.5–160 bar (239.25–2320 psi)
	1st stage operating point (PH1)	10.5–154 bar (152.25–2233 psi)
Spread between the two stages (PH2–PH1)		6–83 bar (87–1203.5 psi)

Catalog numbers

Fluids controlled For materials in contact with fluid, see page 77.	Hydraulic oils, up to 320 °F (160 °C)	XMLD160D1S13	XMLD160D1S11
	Fresh water, sea water, up to 320 °F (160 °C)	XMLD160E1S13	XMLD160E1S11
	Corrosive fluids, air, up to 320 °F (160 °C)	XMLD160N1S13	XMLD160N1S11

Pressure connection	1/4"-18 NPTF	G 1/4-19
Electrical connection	Conduit/cable entry: 1/2" NPT	Pg 13.5
	Terminals: 1 x 0.2 to 2 x 2.5 mm ² (1 x 24 to 2 x 14 AWG)	

Weight, lb (kg)	1.65 (0.750)
------------------------	--------------

Supplementary specifications (not shown under general specifications)

Inherent differential (subtract from PH1/PH2 to get PB1/PB2)	At low setting	8.8 bar ±1.5 (127.6 psi ±21.75)
	At high setting	20 bar ±7 (290 psi ±101.5)
Maximum allowable pressure	Per cycle	200 bar (2900 psi)
	Accidental	360 bar (5220 psi)
Destruction pressure		720 bar (10,440 psi)
Pressure switch style		Piston

Operating curves

High setting trip points of contacts 1 and 2

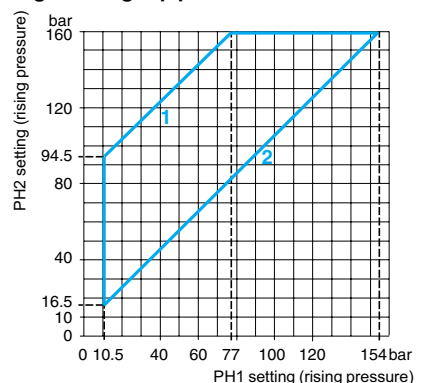

1 Maximum differential
 2 Minimum differential

Inherent differential of contacts 1 and 2

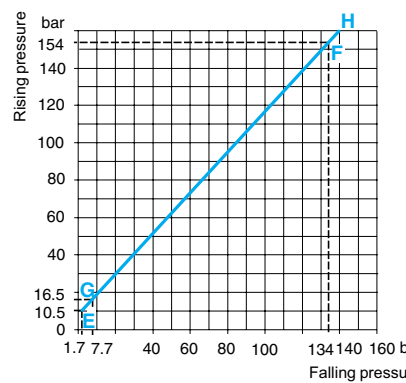

EF Contact 1 (stage 1)
 GH Contact 2 (stage 2)

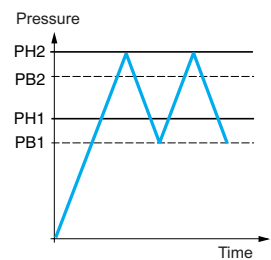

— Adjustable value
 --- Nonadjustable value

Connection

Terminal model
 Contact 2 (stage 2) Contact 1 (stage 1)

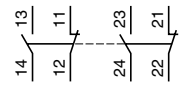

Other versions For switches with alternative tapped cable entries, consult the Customer Care Center.

Size 300 bar (4350 psi)
Fixed differential, for detection of a single threshold
1 C/O single-pole contact

XMLA pressure switches **With setting scale**

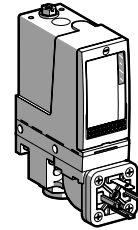
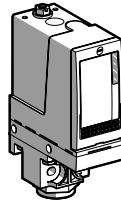

Adjustable range of operating point (PH) (rising pressure)	20–300 bar (290–4350 psi)			
Electrical connection	Terminals	DIN connector		
Catalog numbers (1)				
Fluids controlled For materials in contact with fluid, see page 77. Only for control of group 2 fluids, in accordance with directive 97/23/EEC.	Hydraulic oils, up to 320 °F (160 °C)	XMLA300D2S13	XMLA300D2S11	XMLA300D2C11
	Fresh water, sea water, up to 320 °F (160 °C)	XMLA300E2S13	XMLA300E2S11	XMLA300E2C11
	Corrosive fluids, air, up to 320 °F (160 °C)	XMLA300N2S13	XMLA300N2S11	XMLA300N2C11
Pressure connection		1/4"-18 NPTF	G 1/4-19	G 1/4-19
Electrical connection	Conduit/cable entry	1/2" NPT	Pg 13.5	DIN 43650A, 4-pin male
	Terminals	1 x 0.2 to 2 x 2.5 mm ² (1 x 24 to 2 x 14 AWG)		For suitable female connector, see page 73.
Weight, lb (kg)		1.65 (0.750)	1.72 (0.780)	

Supplementary specifications (not shown under general specifications)

Inherent differential (subtract from PH to get PB)	At low setting	16.5 bar ±3 (239.25 psi ±43.5)
	At high setting	35 bar ±6 (507.5 psi ±87)
Maximum allowable pressure	Per cycle	375 bar (5437.5 psi)
	Accidental	675 bar (9787.5 psi)
Destruction pressure		1350 bar (19,575 psi)
Pressure switch style		Piston

Operating curves **Connection**

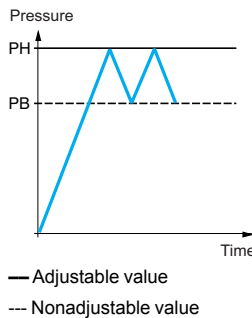
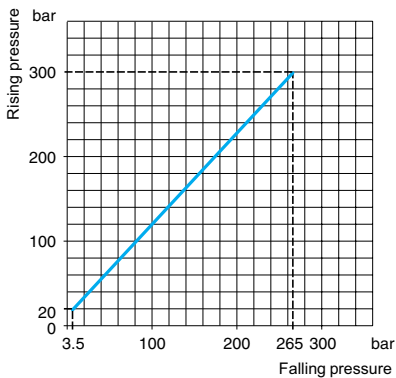

Terminal model



Connector model

Pressure switch connector pin view



- 1 → 11 and 13
- 2 → 12
- 3 → 14

Other versions For switches with alternative tapped cable entries, consult the Customer Care Center.

Size 300 bar (4350 psi)
Adjustable differential, for regulation between two thresholds
1 C/O single-pole contact

XMLB pressure switches **With setting scale**



Adjustable range of operating point (PH) (rising pressure)	22–300 bar (319–4350 psi)			
Catalog numbers				
Fluids controlled For materials in contact with fluid, see page 77. Only for control of group 2 fluids, in accordance with directive 97/23/EEC.	Hydraulic oils, up to 320 °F (160 °C)	XMLB300D2S13	XMLB300D2S11	XMLB300D2C11
	Fresh water, sea water, up to 320 °F (160 °C)	XMLB300E2S13	XMLB300E2S11	XMLB300E2C11
	Corrosive fluids, air, up to 320 °F (160 °C)	XMLB300N2S13	XMLB300N2S11	XMLB300N2C11
Pressure connection	1/4"-18 NPTF	G 1/4-19	G 1/4-19	
Electrical connection	Conduit/cable entry	1/2" NPT	Pg 13.5	DIN 43650A, 4-pin male.
	Terminals	1 x 0.2 to 2 x 2.5 mm ² (1 x 24 to 2 x 14 AWG) For suitable female connector, see page 73.		
Weight, lb (kg)	1.65 (0.750)		1.72 (0.780)	

Supplementary specifications (not shown under general specifications)

Possible differential (subtract from PH to get PB)	Min. at low setting	19.4 bar –1.5, +1.7 (281.3 psi, –21.75, +24.65)
	Min. at high setting	37 bar, –1, +4 (536.5 psi, –14.5, +58)
	Max. at high setting	200 bar (2900 psi)
Maximum allowable pressure	Per cycle	375 bar (5437.5 psi)
	Accidental	675 bar (9787.5 psi)
Destruction pressure	1350 bar (19,575 psi)	
Pressure switch style	Piston	

Operating curves **Connection**

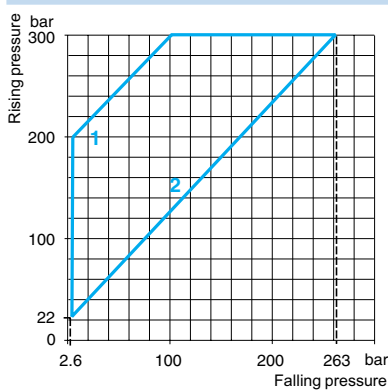

1 Maximum differential
 2 Minimum differential

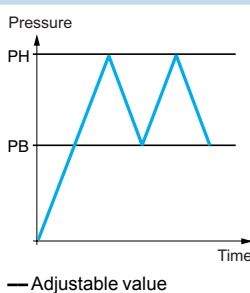

Terminal model



Connector model

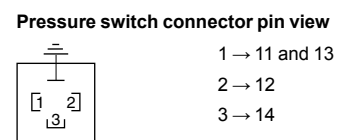

Other versions For switches with alternative tapped cable entries, consult the Customer Care Center.

Size 300 bar (4350 psi)
Adjustable differential, for regulation between two thresholds
2 C/O single-pole contacts

XMLC pressure switches **With setting scale**

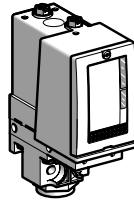

Adjustable range of operating point (PH) (rising pressure)	22–300 bar (319–4350 psi)		
Catalog numbers			
Fluids controlled For materials in contact with fluid, see page 77. Only for control of group 2 fluids, in accordance with directive 97/23/EEC.	Hydraulic oils, up to 320 °F (160 °C)	XMLC300D2S13	XMLC300D2S11
	Fresh water, sea water, up to 320 °F (160 °C)	XMLC300E2S13	XMLC300E2S11
	Corrosive fluids, air, up to 320 °F (160 °C)	XMLC300N2S13	XMLC300N2S11
Pressure connection		1/4"-18 NPTF	G 1/4-19
Electrical connection	Conduit/cable entry	1/2" NPT	Pg 13.5
	Terminals	1 x 0.2 to 2 x 2.5 mm ² (1 x 24 to 2 x 14 AWG)	
Weight, lb (kg)	1.65 (0.750)		
Supplementary specifications (not shown under general specifications)			
Possible differential (subtract from PH to get PB)	Min. at low setting	16 bar ±0.9 (232 psi ±13.05)	
	Min. at high setting	35 bar ±0.9 (507.5 psi ±13.05)	
	Max. at high setting	240 bar (3480 psi)	
Maximum allowable pressure	Per cycle	375 bar (5437.5 psi)	
	Accidental	675 bar (9787.5 psi)	
Destruction pressure	1350 bar (19,575 psi)		
Mechanical life (depending on the application)	3 x 10 ⁶ operating cycles		
Pressure switch style	Piston		

Operating curves **Connection**

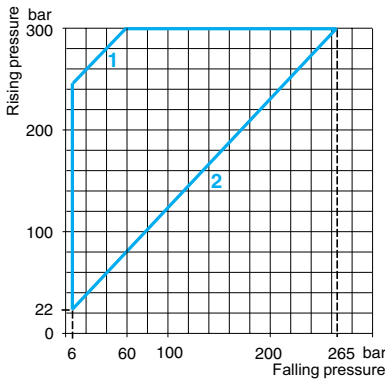

1 Maximum differential
2 Minimum differential

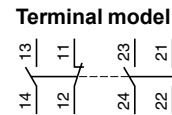
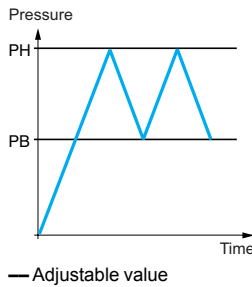

Other versions For switches with alternative tapped cable entries, consult the Customer Care Center.

Size 300 bar (4350 psi)
Dual-stage, fixed differential, for detection at each threshold
2 C/O single-pole contacts (one per stage)

XMLD pressure switches Without setting scale

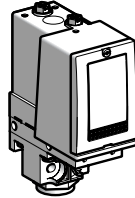

Adjustable range of each operating point (rising pressure)	2nd stage operating point (PH2)	36–300 bar (522–4350 psi)
	1st stage operating point (PH1)	25–289 bar (362.5–4190.5 psi)
Spread between the two stages (PH2–PH1)		11–189 bar (159.5–2740.5 psi)

Catalog numbers

Fluids controlled For materials in contact with fluid, see page 77. Only for control of group 2 fluids, in accordance with directive 97/23/EEC.	Hydraulic oils, up to 320 °F (160 °C)	XMLD300D1S13	XMLD300D1S11
	Fresh water, sea water, up to 320 °F (160 °C)	XMLD300E1S13	XMLD300E1S11
	Corrosive fluids, air, up to 320 °F (160 °C)	XMLD300N1S13	XMLD300N1S11

Pressure connection	1/4"-18 NPTF	G 1/4-19
----------------------------	--------------	----------

Electrical connection	Conduit/cable entry	1/2" NPT	Pg 13.5
	Terminals	1 x 0.2 to 2 x 2.5 mm ² (1 x 24 to 2 x 14 AWG)	

Weight, lb (kg)	1.65 (0.750)	
------------------------	--------------	--

Supplementary specifications (not shown under general specifications)

Inherent differential (subtract from PH1/PH2 to get PB1/PB2)	At low setting	17 bar ±2.5 (246.5 psi ±36.25)
	At high setting	42 bar ±9 (609 psi ±130.5)
Maximum allowable pressure	Per cycle	375 bar (5437.5 psi)
	Accidental	675 bar (9787.5 psi)
Destruction pressure		1350 bar (19,575 psi)

Operating curves

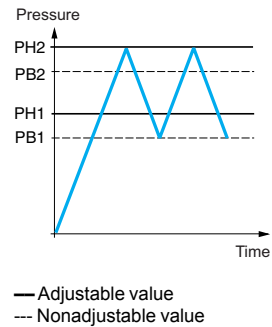
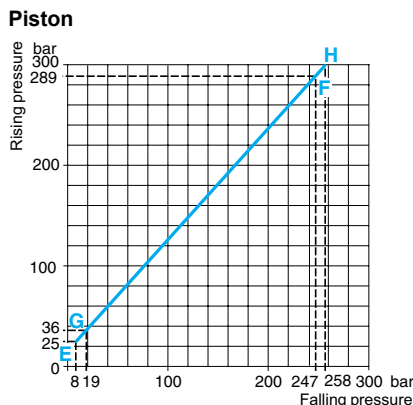
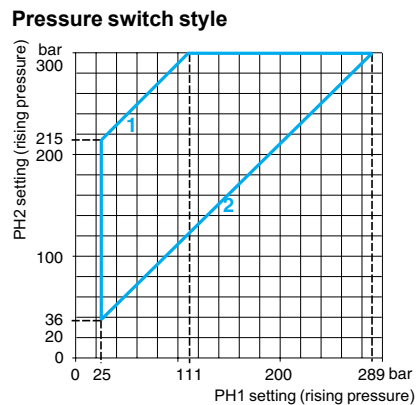

Connection

Terminal model
 Contact 2 (stage 2) Contact 1 (stage 1)

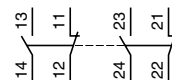

Other versions For switches with alternative tapped cable entries, consult the Customer Care Center.

Size 500 bar (7250 psi)
Fixed differential, for detection of a single threshold
1 C/O single-pole contact

XMLA pressure switches	With setting scale	Without setting scale
------------------------	--------------------	-----------------------

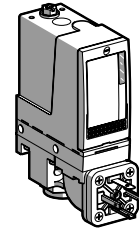
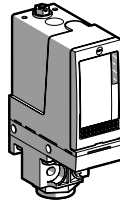

Adjustable range of operating point (PH) (rising pressure)	30–500 bar (435–7250 psi)		
--	---------------------------	--	--

Catalog numbers (1)				
---------------------	--	--	--	--

Fluids controlled For materials in contact with fluid, see page 77. Only for control of group 2 fluids, in accordance with directive 97/23/EEC.	Hydraulic oils, up to 320 °F (160 °C)	XMLA500D2S13	XMLA500D2S11	XMLA500D2C11
	Fresh water, sea water, up to 320 °F (160 °C)	XMLA500E2S13	XMLA500E2S11	XMLA500E2C11
	Corrosive fluids, air, up to 320 °F (160 °C)	XMLA500N2S13	XMLA500N2S11	XMLA500N2C11

Pressure connection	1/4"-18 NPTF	G 1/4-19	G 1/4-19
----------------------------	--------------	----------	----------

Electrical connection	Conduit/cable entry	1/2" NPT	Pg 13.5	DIN 43650A, 4-pin male
	Terminals	1 x 0.2 to 2 x 2.5 mm ² (1 x 24 to 2 x 14 AWG)		For suitable female connector, see page 73.

Weight, lb (kg)	1.65 (0.750)	1.72 (0.780)
------------------------	--------------	--------------

Supplementary specifications (not shown under general specifications)		
---	--	--

Inherent differential (subtract from PH to get PB)	At low setting	20 bar ±6 (290 psi ±87)
	At high setting	45 bar ±10 (652.5 psi ±145)

Maximum allowable pressure	Per cycle	625 bar (9062.5 psi)
	Accidental	1125 bar (16,312.5 psi)

Destruction pressure	2250 bar (32,625 psi)
-----------------------------	-----------------------

Mechanical life (depending on the application)	3 x 10 ⁶ operating cycles
---	--------------------------------------

Pressure switch style	Piston
------------------------------	--------

Operating curves	Connection
------------------	------------

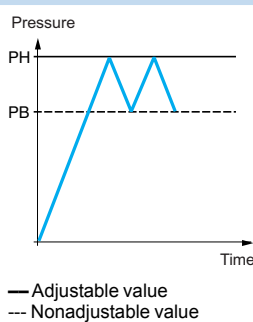
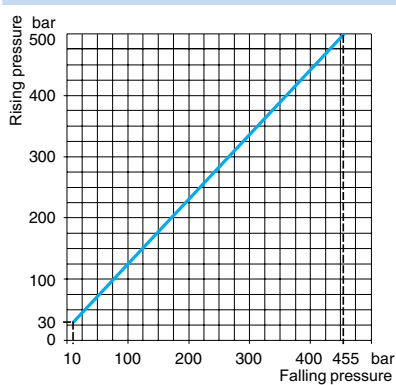

Terminal model



Connector model

Pressure switch connector pin view

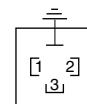

- 1 → 11 and 13
- 2 → 12
- 3 → 14

Other versions For switches with alternative tapped cable entries, consult the Customer Care Center.

Size 500 bar (7250 psi)
Adjustable differential, for regulation between two thresholds
1 C/O single-pole contact

XMLB pressure switches **With setting scale**

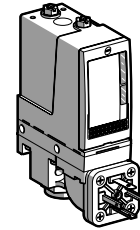
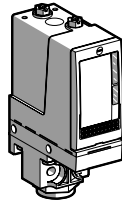

Adjustable range of operating point (PH) (rising pressure)	30–500 bar (435–7250 psi)
--	---------------------------

Catalog numbers

Fluids controlled For materials in contact with fluid, see page 77. Only for control of group 2 fluids, in accordance with directive 97/23/EEC.	Hydraulic oils, up to 320 °F (160 °C)	XMLB500D2S13	XMLB500D2S11	XMLB500D2C11
	Fresh water, sea water, up to 320 °F (160 °C)	XMLB500E2S13	XMLB500E2S11	XMLB500E2C11
	Corrosive fluids, air, up to 320 °F (160 °C)	XMLB500N2S13	XMLB500N2S11	XMLB500N2C11

Pressure connection	1/4"-18 NPTF	G 1/4-19	G 1/4-19
----------------------------	--------------	----------	----------

Electrical connection	Conduit/cable entry	1/2" NPT	Pg 13.5	DIN 43650A, 4-pin male
	Terminals	1 x 0.2 to 2 x 2.5 mm ² (1 x 24 to 2 x 14 AWG)		For suitable female connector, see page 73.

Weight, lb (kg)	1.65 (0.750)	1.72 (0.780)
------------------------	--------------	--------------

Supplementary specifications (not shown under general specifications)

Possible differential (subtract from PH to get PB)	Min. at low setting	23 bar, -2.6, +3.8 (333.5 psi, -37.7, +55.1)
	Min. at high setting	52.6 bar, -14.8, +11.2 (762.7 psi, -214.6, +162.4)
	Max. at high setting	300 bar (4350 psi)

Maximum allowable pressure	Per cycle	625 bar (9062.5 psi)
	Accidental	1125 bar (16,312.5 psi)

Destruction pressure	2250 bar (32,625 psi)
-----------------------------	-----------------------

Pressure switch style	Piston
------------------------------	--------

Operating curves **Connection**

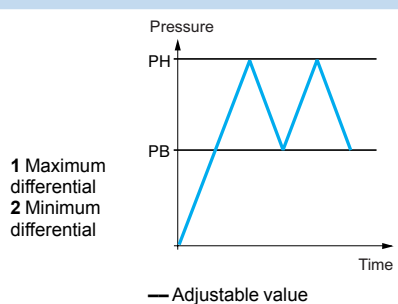
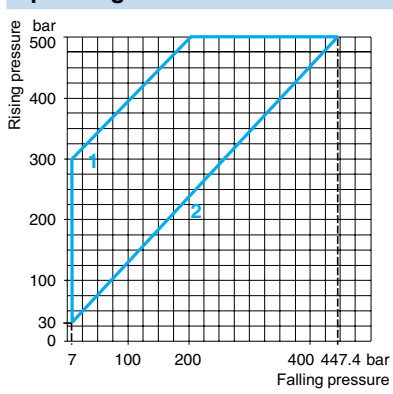

Terminal model

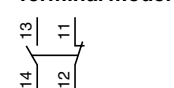

Connector model

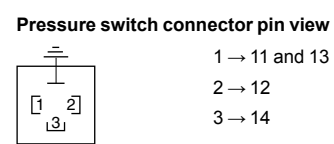

Other versions For switches with alternative tapped cable entries, consult the Customer Care Center.

Size 500 bar (7250 psi)
Adjustable differential, for regulation between 2 thresholds
2 C/O single-pole contacts

XMLC pressure switches **With setting scale**

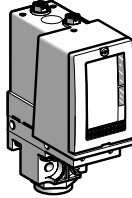

Adjustable range of operating point (PH) (rising pressure)	30–500 bar (435–7250 psi)
--	---------------------------

Electrical connection	Terminals
------------------------------	-----------

Catalog numbers

Fluids controlled For materials in contact with fluid, see page 77. Only for control of group 2 fluids, in accordance with directive 97/23/EEC.	Hydraulic oils, up to 320 °F (160 °C)	XMLC500D2S13	XMLC500D2S11
	Fresh water, sea water, up to 320 °F (160 °C)	XMLC500E2S13	XMLC500E2S11
	Corrosive fluids, air, up to 320 °F (160 °C)	XMLC500N2S13	XMLC500N2S11

Pressure connection	1/4"–18 NPTF	G 1/4–19
----------------------------	--------------	----------

Electrical connection	Conduit/cable entry	1/2" NPT	Pg 13.5
	Terminals	1 x 0.2 to 2 x 2.5 mm ² (1 x 24 to 2 x 14 AWG)	

Weight, lb (kg)	1.65 (0.750)
------------------------	--------------

Supplementary specifications (not shown under general specifications)

Possible differential (subtract from PH to get PB)	Min. at low setting	19 bar ±0.9 (275.5 psi ±13.05)
	Min. at high setting	52 bar ±0.9 (754 psi ±13.05)
	Max. at high setting	340 bar (4930 psi)

Maximum allowable pressure	Per cycle	625 bar (9062.5 psi)
	Accidental	1125 bar (16,312.5 psi)

Destruction pressure	2250 bar (32,625 psi)
-----------------------------	-----------------------

Pressure switch style	Piston
------------------------------	--------

Operating curves **Connection**

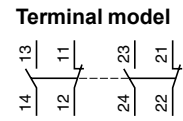
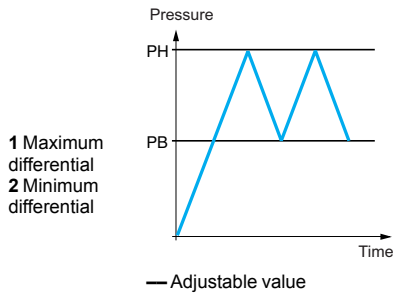
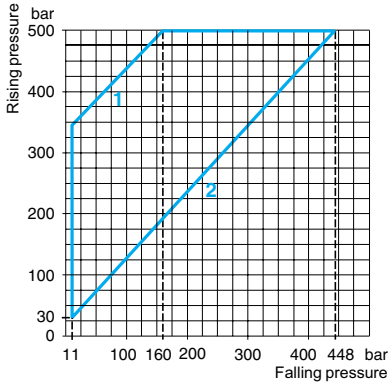

1 Maximum differential
 2 Minimum differential

— Adjustable value

Other versions For switches with alternative tapped cable entries, consult the Customer Care Center.

Size 500 bar (7250 psi)
Dual-stage, fixed differential, for detection at each threshold
2 C/O single-pole contacts (one per stage)

XMLD pressure switches Without setting scale

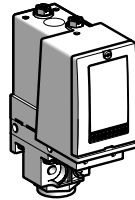

Adjustable range of each operating point (rising pressure)	2nd stage operating point (PH2)	41–500 bar (594.5–7250 psi)	
	1st stage operating point (PH1)	25–484 bar (362.5–7018 psi)	
Spread between the two stages (PH2–PH1)		16–244 bar (232–3538 psi)	
Catalog numbers			
Fluids controlled For materials in contact with fluid, see page 77. Only for control of group 2 fluids, in accordance with directive 97/23/EEC.	Hydraulic oils, up to 320 °F (160 °C)	XMLD500D1S13	XMLD500D1S11
	Fresh water, sea water, up to 320 °F (160 °C)	XMLD500E1S13	XMLD500E1S11
	Corrosive fluids, air, up to 320 °F (160 °C)	XMLD500N1S13	XMLD500N1S11
Pressure connection		1/4"-18 NPTF	G 1/4-19
Electrical connection	Conduit/cable entry	1/2" NPT	Pg 13.5 conduit/cable entry
	Terminals	1 x 0.2 to 2 x 2.5 mm ² (1 x 24 to 2 x 14 AWG)	
Weight, lb (kg)	1.65 (0.750)		
Supplementary specifications (not shown under general specifications)			
Inherent differential (subtract from PH1/PH2 to get PB1/PB2)	At low setting	21 bar ±3 (304.5 psi ±43.5)	
	At high setting	65 bar ±10 (942.5 psi ±145)	
Maximum allowable pressure	Per cycle	625 bar (9,062.5 psi)	
	Accidental	1125 bar (16,312.5 psi)	
Destruction pressure	2250 bar (32,625 psi)		
Pressure switch style	Piston		

Operating curves

High setting trip points of contacts 1 and 2

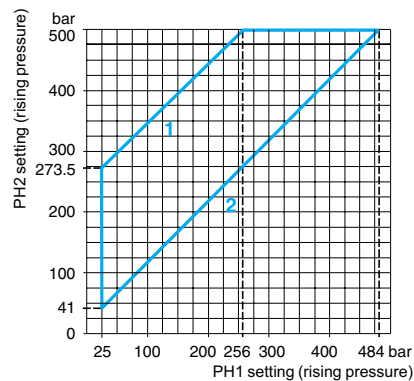

1 Maximum differential
 2 Minimum differential

Inherent differential of contacts 1 and 2

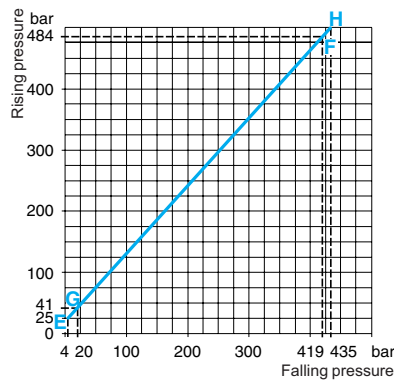

EF Contact 1 (stage 1)
 GH Contact 2 (stage 2)

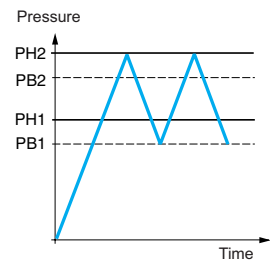

— Adjustable value
 --- Nonadjustable value

Connection

Terminal model

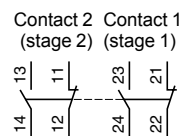

Other versions For switches with alternative tapped cable entries, consult the Customer Care Center.

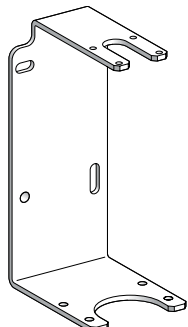

XMLZL006

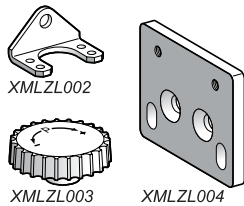

XMLZL002



XMLZL003

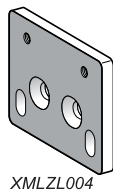

XMLZL004

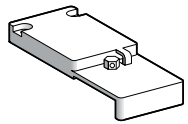

XMLZL001

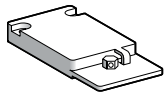

XMLZL011

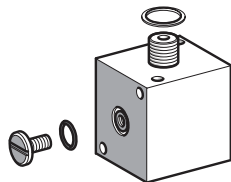

XMLZL005

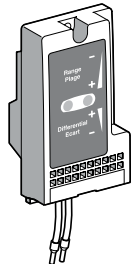

XMLZA...
XMLZB...

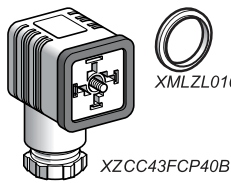

XMLZL010

XZCC43FCP40B

Accessories for pressure switches and vacuum switches

Description	Specific characteristics	For use with switches	Catalog number	Weight lb (kg)	
Rear fixing bracket for vibrations > 2 gn	—	XML•L35 XML•001	XMLZL006	0.51 (0.230)	
Additional top support bracket for vibrations > 4 gn	—	XMLAM01 XML•M05 XMLA004 XML•010 to XML•500	XMLZL002	0.04 (0.020)	
Knurled adjustment knob, Ø36 mm fits over adjustment screw(s) to facilitate setting	—	All models	XMLZL003	0.022 (0.010)	
Mounting plate for replacing an XMJA or XMGB switch by an XML switch	—	XMLAM01 XML•M05 XMLA004 XML•010 to XML•500	XMLZL004	0.024 (0.110)	
Lead sealable protective cover to prevent unauthorized access to adjustment screws and fixing screw of switch cover	—	XMLA XMLB	XMLZL001	0.08 (0.035)	
Lead sealable protective cover to deter unauthorized access to the adjustment screws	—	All models	XMLZL011	0.07 (0.030)	
Indicator modules and associated covers, 2 LEDs (orange and green)	Without setting scale	24/48 Vac/Vdc	XMLA/B	XMLZZ024	0.20 (0.090)
		110/240 Vac	XMLA/B	XMLZZ120	0.20 (0.090)
	With setting scale	24/48 Vac/Vdc	XMLA	XMLZA024	0.20 (0.090)
			XMLB	XMLZB024	0.20 (0.090)
		110/240 Vac	XMLA	XMLZA120	0.20 (0.090)
			XMLB	XMLZB120	0.20 (0.090)
Hydraulic block for base mounting directly onto fluid manifold	—	All models	XMLZL005	0.53 (0.240)	
Female connector, DIN 43650A	—	XML•.....C11	XZCC43FCP40B	0.08 (0.035)	
Jumper cables, DIN 43650A - M12, straight male, for splitter boxes	1 m	XML•.....C11	XZCR1523062K1	0.18 (0.080)	
	2 m	XML•.....C11	XZCR1523062K2	0.024 (0.110)	
Adapter, G 1/4" – G 3/8" male/female	—	All models	XMLZL012	0.29 (0.130)	

Renewal parts

Description	Specific characteristics	For use with switches	Catalog number	Weight lb (kg)
Sealing gasket	For sizes ≥ 300 bar	XMLA/B/C/D	XMLZL010	0.03 (0.015)
Diaphragms	—	XML•S35	XMLZL013	0.13 (0.060)
		XML•S02	XMLZL014	0.09 (0.040)
		XML•S04	XMLZL015	0.07 (0.030)

Connector pinout

XZCC43FCP40B

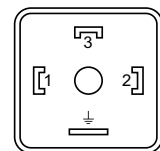

Jumper cables, DIN 43650A, M12 straight male

XZCR15230D62K•

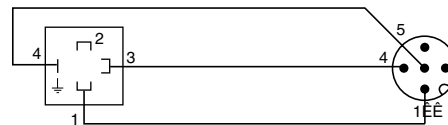

Cable connections

XZCPV, XZCP

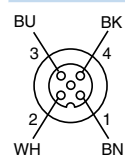

XZCC43F

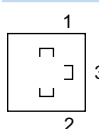

XZCC12F

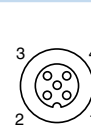

OsiSense XML

Electromechanical pressure and vacuum switches

XML•L35, XML•001, XML•S

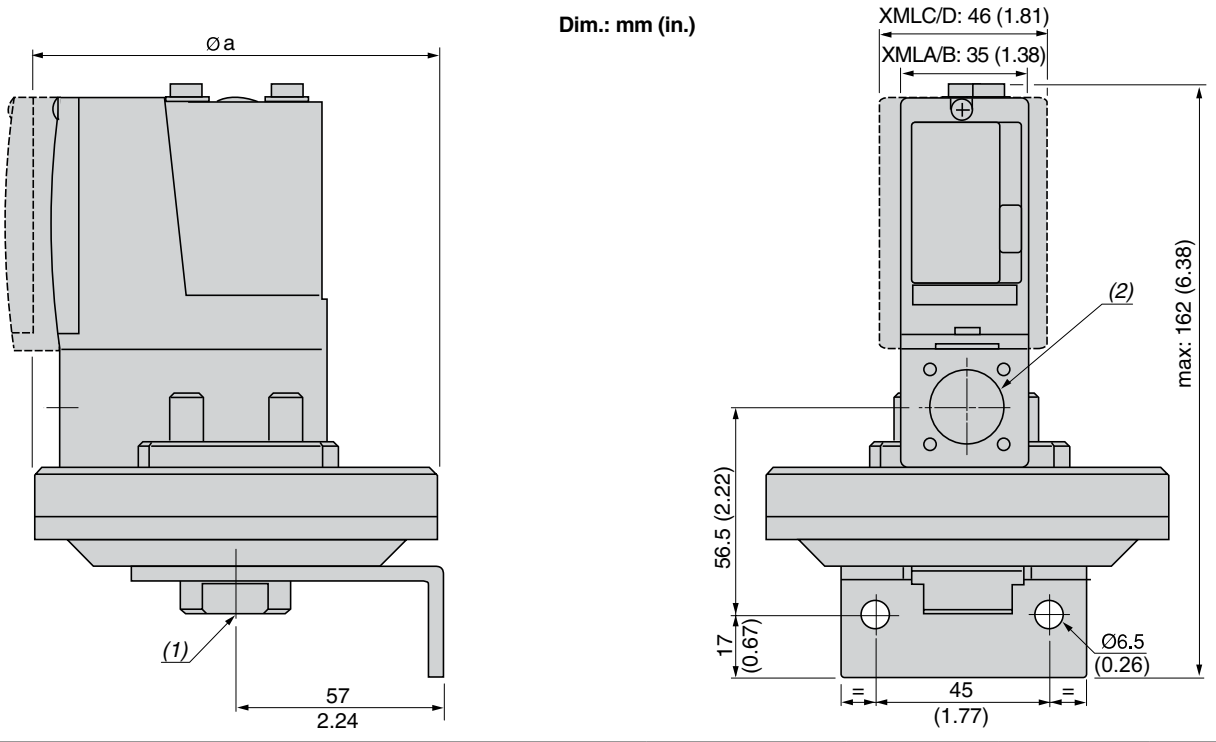

(1) 1 fluid entry, tapped G 1/4 (BSP female)

(2) 1 electrical connection entry, tapped M20 x 1.5, Pg 13.5, or 1/4"-18 NTP

XMLBM03, XMLBL05

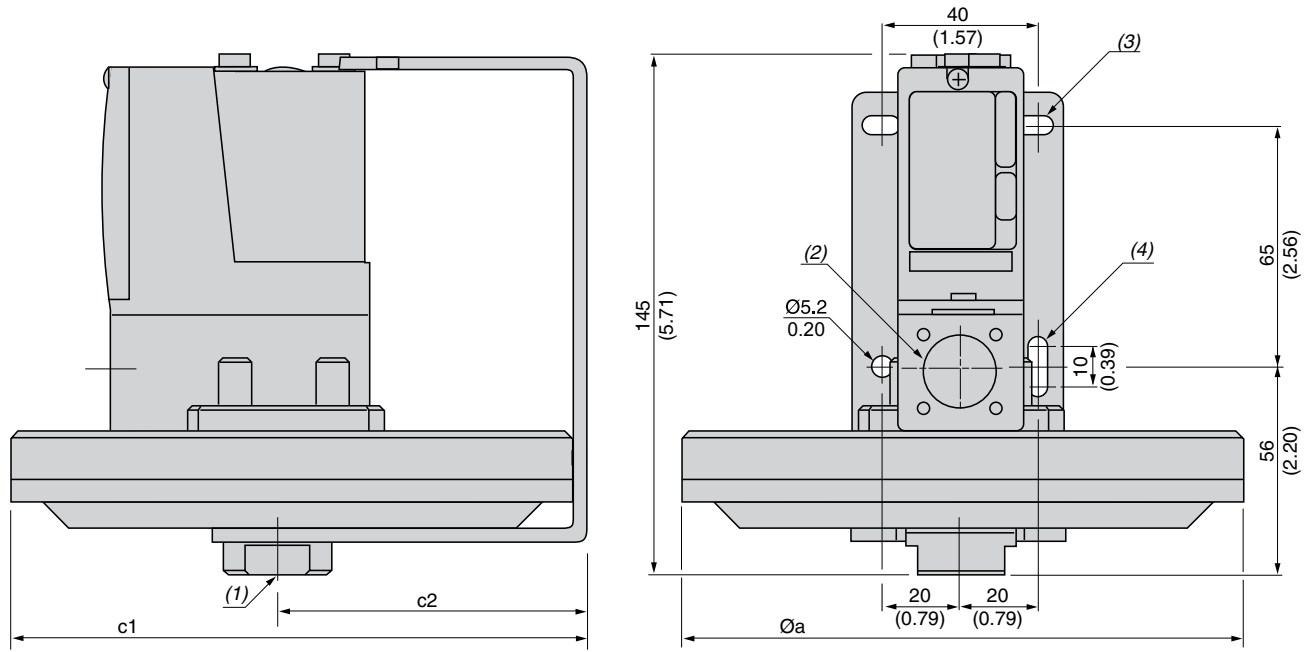

(1) 1 fluid entry, tapped G 1/4 (BSP female)

(2) 1 electrical connection entry, tapped M20 x 1.5, Pg 13.5, or 1/2" NTP

(3) 2 elongated holes $\varnothing 10.2 \times 5.2$ (0.40 x 0.20)

(4) 1 elongated hole $\varnothing 15.2 \times 5.2$ (0.60 x 0.20)

XML	$\varnothing a$	c1	c2
BM03	150 (5.91)	155.5 (6.12)	80.5 (3.17)
BL05	200 (7.87)	204 (8.03)	104 (4.09)
•L35, •001	110 (4.33)	—	—
•S35, •S02, •S04	110 (4.33)	—	—
•S10, •S20	86 (3.39)	—	—

OsiSense XML

Electromechanical pressure and vacuum switches

XMLAM01, XMLBM05, XMLCM05, XMLA004, XML-010 to 500

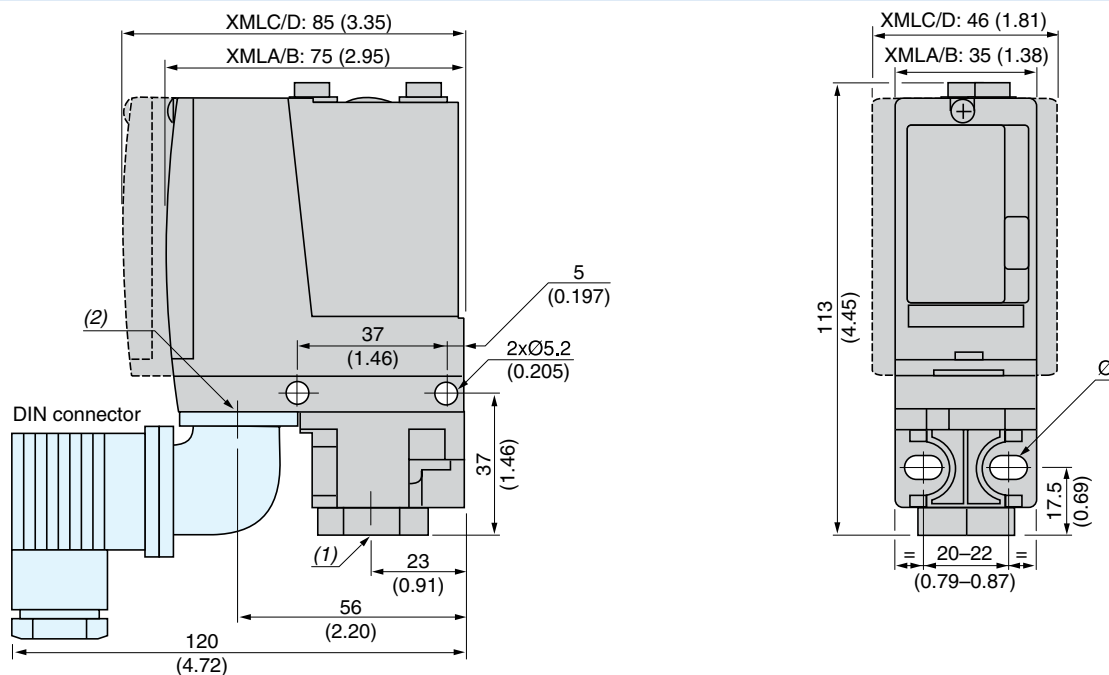

(1) 1 fluid entry, tapped G 1/4 (BSP female)

(2) 1 electrical connection entry, tapped M20 x 1.5, Pg 13.5, or 1/4"-18 NTP

Ø: 2 elongated holes, Ø5.2 x 6.7

XML-M02, XML-002, XMLB004, XMLC004, XMLD004

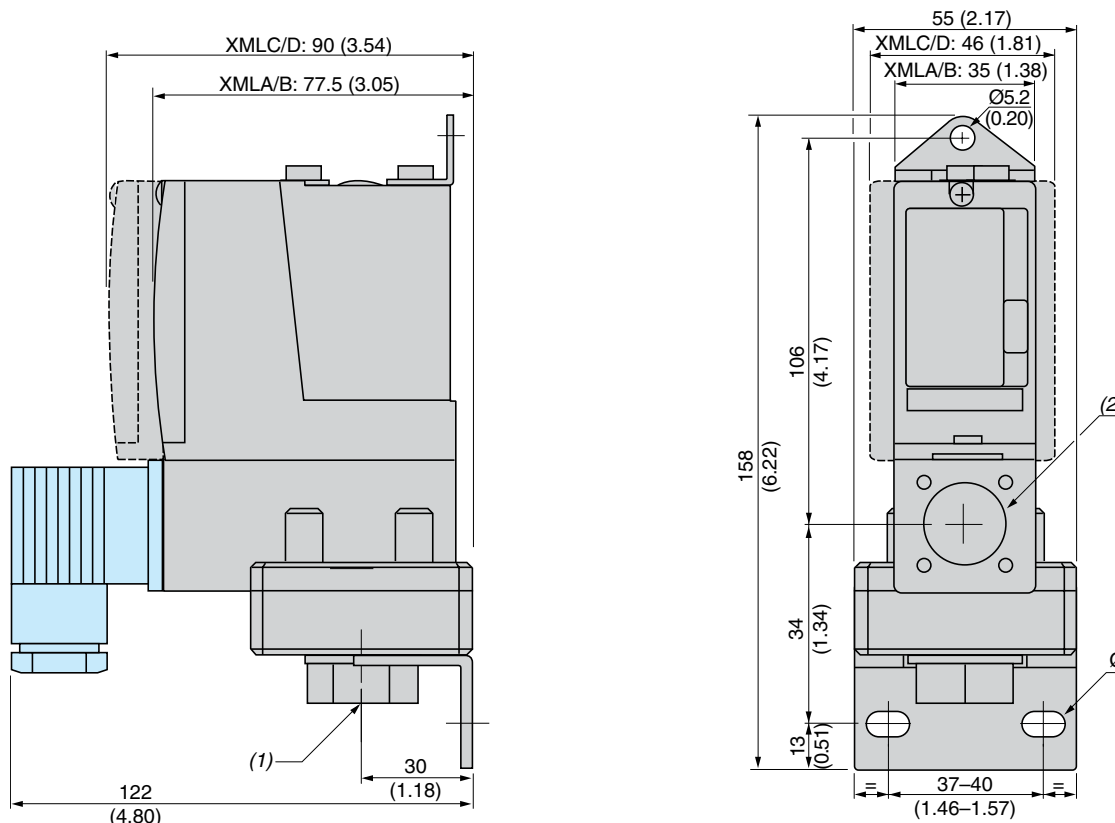

(1) 1 fluid entry, tapped G 1/4 (BSP female)

(2) 1 electrical connection entry, tapped M20 x 1.5, Pg 13.5, or 1/4"-18 NTP

Ø: 2 elongated holes, Ø10.2 x 5.2

OsiSense XML

Electromechanical pressure and vacuum switches

XMLBL35P, XMLB001P (viscous products)

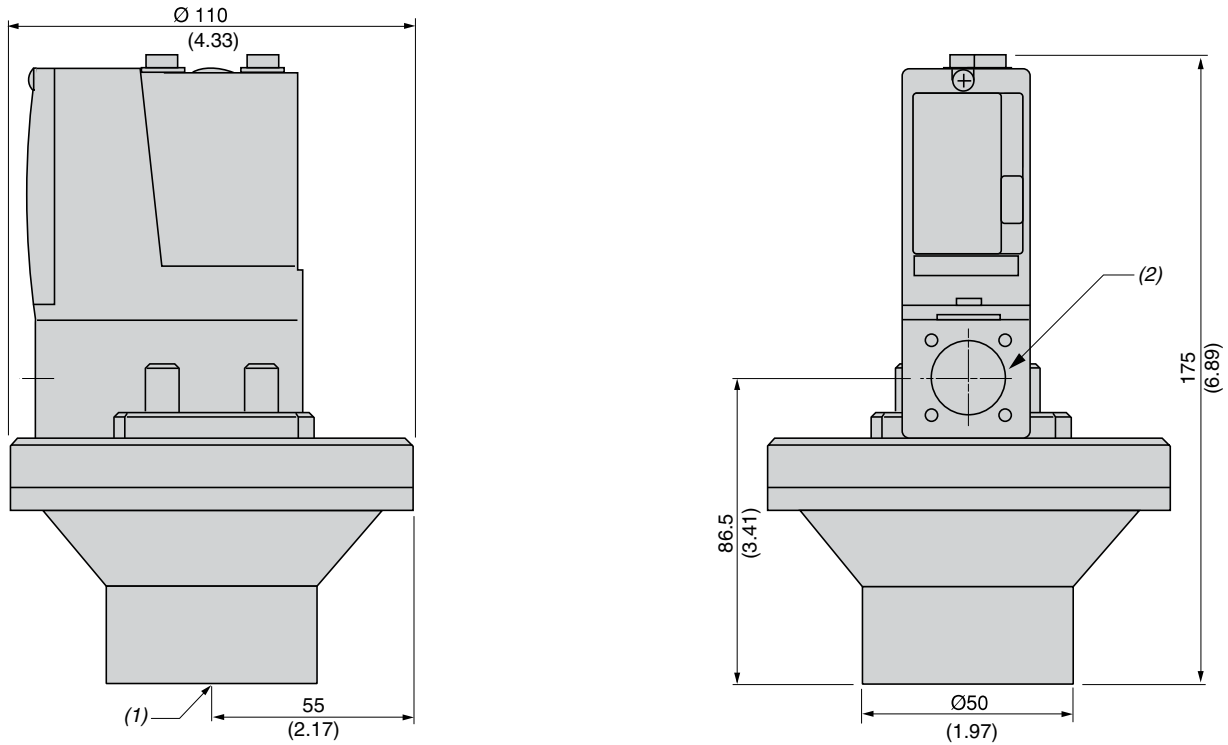

⁽¹⁾ 1 fluid entry, tapped G 1-1/4 (BSP female).

⁽²⁾ 1 electrical connection entry, tapped M20 x 1.5 or Pg 13.5.

XMLBM05P, XMLA004P, XML-010P, XML-020P, XML-035P (viscous products)

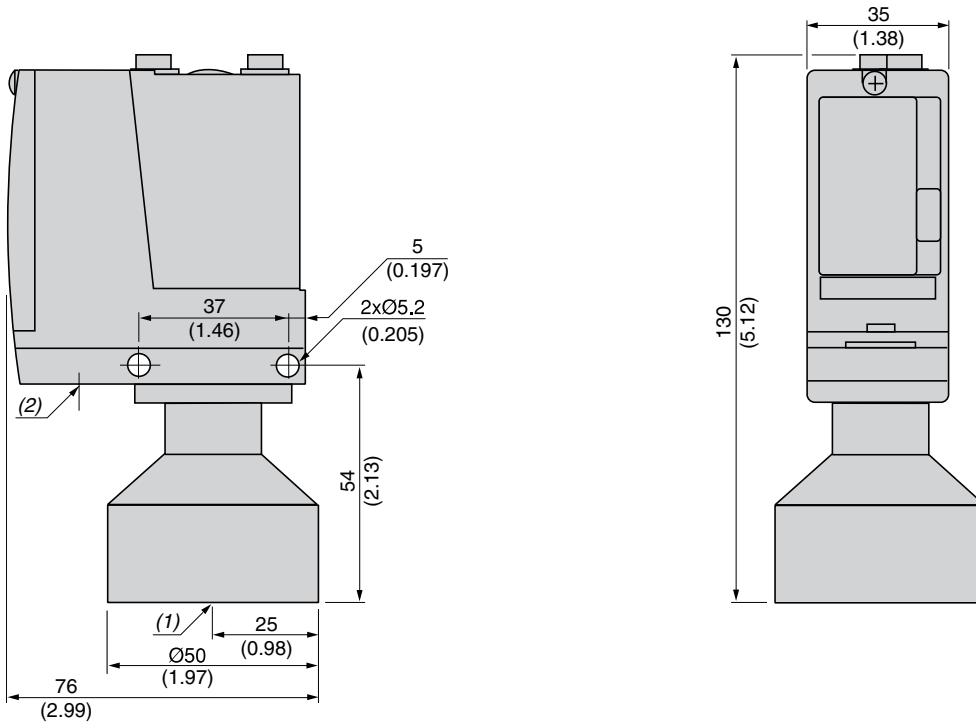

⁽¹⁾ 1 fluid entry, tapped G 1-1/4 (BSP female).

⁽²⁾ 1 electrical connection entry, tapped M20 x 1.5 or Pg 13.5.

Component Materials in Contact with Fluid								
Pressure or vacuum switch catalog number	Zinc alloy	Stainless steel	Brass	Steel	Nitrile	PTFE	FPM, FKM	Aluminium
XMLAM01V****, XML•M02V****		(1)						
XMLAM01T****, XML•M02T****		(2)						
XMLBM03R****								
XMLBM03S****		(3)						
XML•M05A****		(1)						
XML•M05B****		(1)						
XML•M05C****		(1)						
XMLBM05****		(1)						
XMLBL05R****								
XMLBL05S****		(3)						
XML•L35R****, XML•S35R****		(1)						
XML•L35S****		(3)						
XMLBL35P****		(1)						
XML•001R****		(1)						
XML•001S****		(3)						
XMLB001P****		(1)						
XML•002A****								
XML•002B****, XML•S02B****								
XML•002C****		(3)						
XMLA004A****								
XMLA004B****								
XMLA004C****		(2)						
XMLA004P****								

 Materials in contact with fluid

(1) 1.4307 (AISI 316L)
(2) 1.4404 (AISI 316L)
(3) 1.4305 (AISI 303)

Component Materials in Contact with Fluid (continued)

Pressure switch catalog number	Zinc alloy	Stainless steel	Brass	Steel	Nitrile	PTFE	FPM, FKM	Aluminium
XMLB004A****								
XML-004B****, XML-S04B****								
XML-004C****		(3)						
XML-010A****								
XML-010B****								
XML-010C****		(2)						
XML-010P****, XML-S10A****								
XML-020A****, XML-035A****								
XML-020B****, XML-035B****								
XML-020C****, XML-035C****		(2)						
XML-020P****, XML-035P****, XML-S20A****								
XML-070D****, XML-160D****								
XML-070E****, XML-160E****		(4)						
XML-070N****, XML-160N****		(5)						
XML-300D****								
XML-300E****		(4)						
XML-300N****		(5)						
XML-500D****								
XML-500E****								
XML-500N****4		(5)						

 Materials in contact with fluid

Grade of Stainless Steel

- ⁽¹⁾ 1.4307 (AISI 316L)
- ⁽²⁾ 1.4404 (AISI 316L)
- ⁽³⁾ 1.4305 (AISI 303)
- ⁽⁴⁾ 1.4404 (AISI 316L) + 1.4462
- ⁽⁵⁾ 1.4404 (AISI 316L) + 1.4305 (AISI 303)

9012G and 9016G

Industrial pressure and vacuum switches

9012G pressure switches

Introduction

The 9012G pressure switches are UL Listed and CSA certified as industrial control equipment. They are used to interface pneumatic or hydraulic systems with electrical control systems by opening or closing electrical contacts in response to pressure changes in the system. They have outstanding repeatability and drift performance. Their efficient design uses durable, low mass components for excellent performance under heavy duty vibration and shock conditions.

The 9012G pressure switches line offers devices with either diaphragm or piston actuators—for optimum life, versatility, and speed of operation. Features include the following:

- High shock resistance
- High set-point stability
- Internal or external range adjustment
- No drain line required
- Dual numerical range scale (psi and kPa)
- One or two SPDT double-break contacts
- Adjustable or fixed (nonadjustable) differential
- Single-stage, dual-stage, or differential-pressure operation

A variety of modifications is available (see also page 12):

The 9012G diaphragm switches range from 0.2–675 psi falling pressure. Nitrile diaphragms and zinc-plated steel flanges are standard. Diaphragms of Viton® fluorocarbon or ethylene propylene are available as well as stainless steel flanges.

The 9012G piston-actuated switches range from 20–9,000 psi falling pressure. They have sealed pistons and can be used on air, water, oil, or any media compatible with the actuator material. The switches come standard with stainless steel pistons and housings, Viton diaphragms and O-ring seals, and Teflon® retaining rings. Ethylene propylene diaphragms and O-ring seals are also available.

The 9012G industrial pressure switches are available as open type or in NEMA 1 enclosures. The backplate is steel with a plastic cover. Open devices in pressure ranges up to 250 psi are available with internal- or external-threaded pressure connectors, ideally suiting them for panel mounting.

The 9012G machine tool pressure switches with NEMA 4, 4X, or 13 (IP66) cast aluminum enclosures are UL Listed and CSA certified as industrial control equipment. They are also UL Marine Listed for use on vessels greater than 65 ft long where ignition protection is not required.

The 9012G machine tool switches are also available in NEMA 7 & 9 cast aluminum enclosures. These are UL Listed for use in Class I, Divisions 1 and 2, Groups C and D, and Class II, Divisions 1 and 2, Groups E, F, G hazardous locations.

Application and general information

9012 pressure switches can generally be used in any application where electrical contacts must open or close in response to a system pressure change, within the electrical and pressure ratings of the switch. Pressure switches are used in a wide variety of applications such as the following:

- compressed air systems
- HVAC equipment
- chillers
- pumping systems
- machine tools
- stamping presses
- automatic grinders
- welders
- process equipment
- molding machines

Pressure switches typically perform one of the following two functions:

Monitoring the pressure in the system. The switch can be used either as an interlock that sequences operations in an automatic system, or to give an audio or visual signal, typically an alarm of an undesired condition, at predetermined pressures. A switch with a **fixed** differential is generally used in these applications.

Controlling the pressure in the system by starting and stopping a pump or a compressor at predetermined pressures. A switch with an **adjustable** differential is usually needed in these applications.

9012G and 9016G

Industrial pressure and vacuum switches

9012G pressure switches

Diaphragm life

The elastomer diaphragms used on 9012G switches can withstand high speed cycling and wide pressure changes. They can tolerate operating speeds up to 200 cycles per minute with no negative impact on the life of the diaphragm.

Diaphragm life is affected by pressure medium compatibility. Standard diaphragms on 9012G devices are nitrile in zinc-plated steel flanges. Also available are Viton fluorocarbon and ethylene propylene diaphragms, as well as Type 316 stainless steel flanges.

The diaphragm can withstand wide pressure changes on each operating cycle. However, the pressure applied to the diaphragm during the normal operating cycle should never exceed the maximum value listed in the Range column in the catalog listing. Regularly cycling the pressure above this value reduces life considerably. If significant surges are common, or if pressures are higher than those listed in the Range column, consider using a piston device.

Piston life

For long piston life, the pressure medium should be filtered to keep foreign matter such as dirt and chips out of the piston assembly. 9012G sealed piston devices are not recommended for use on dry gas media, since this usage could cause some leakage past the seal. Depending on the gas, the media pressure, and the rate of operation, the amount of leakage could render the switch inoperable. (Note, however, that some weepage of the media is necessary to lubricate the seals. This small amount of weepage does not indicate a problem.)

Surges

One of the most destructive conditions for a pressure switch is hydraulic surge. A surge is a high rate of rise in pressure, normally of short duration, caused by starting a pump or by opening and closing a valve. Extremely high rates of rise in pressure can be damaging even if they are within the limits of the maximum allowable pressure.

To limit the effect of surges, the switch should be mounted as close to an accumulator and as far from the pump or quick acting valve as possible. The 9012G piston-actuated switches have a 0.020 in. pressure orifice to help reduce the effects of minor surges. 9012G diaphragm-actuated switches have a 0.060 in. pressure orifice. A restrictor with a small orifice placed in the line between the switch and the pump or valve will further help to protect the switch. Using a surge snubber such as the 9049A26 or A26S will also protect the switch.

Vibration

Among other things, excessive vibration can cause contact bounce, chatter, or premature contact transfer, especially when system pressure is near the operating point of the switch. Remote mounting of the switch is the best way to avoid problems.

Use on steam

Switches should not be applied directly on steam exceeding 15 psig. However, with steam capillary tubing installed between the pressure connection and the switch, steam pressure up to 250 psig can be applied—provided this does not exceed the maximum allowable pressure rating of the switch or the maximum temperature rating at the actuator. Refer to the instruction bulletin supplied with the device.

Dual-stage operation

The 9012G dual-stage pressure switches provide two distinct levels of control from one device. These switches are most commonly used where dual functions are required, or in sequencing applications such as alarm-shutdowns.

Differential-pressure operation

The 9012G pressure switches for differential-pressure sensing can monitor changes in the difference between two pressures. These unidirectional devices signal that a predetermined pressure difference was reached, resulting from a widening or narrowing of the difference between two pressures.

Piston- vs. diaphragm-actuated devices

Whether to select a piston or diaphragm device depends on several criteria:

- maximum allowable pressure
- range and differential
- surges
- medium (whether hydraulic or pneumatic)

Maximum allowable pressures for piston devices are much higher than for diaphragm devices. Most diaphragm devices have a maximum allowable pressure of 850 psi or less, whereas all piston devices have a maximum allowable pressure of 10,000 psi or more.

Range and differential for diaphragm devices are lower than for piston devices. Many applications call for a low differential, such as 20 psi. This may exclude piston devices, which have a minimum differential of 60 psi or more.

Surges are a part of every hydraulic system. While many are small and have only a small effect on the switch, some are significant and can potentially destroy a pressure switch. Diaphragm devices are the most sensitive to surges and are most easily damaged. Piston devices are more tolerant of surges and last longer in the same application.

Hydraulic systems, which typically use oil-based media, are more demanding applications than pneumatic systems. Pressure switches used in hydraulic applications typically experience higher pressures, have wider pressure variations, and produce more surges, since the medium does not compress. Pneumatic systems, which typically use air, place fewer demands on a system, since these applications typically experience lower pressures and the medium can compress, cushioning the effects of surges. Table 1 offers basic guidelines for determining the selection of a piston- versus a diaphragm-operated pressure switch.

Piston vs. diaphragm

Maximum allowable pressures	High	Piston
	Lower	Diaphragm
Pressures	High pressures	Piston
	Low differentials or pressures	Diaphragm
Surges	Constant	Piston
	Minimal	Diaphragm or piston
Media	Hydraulic systems	Piston
	Pneumatic systems	Diaphragm

Technical overview

Operating points (set points)

Pressure switches have two operating points:

- Increasing pressure (rising pressure)
- Decreasing pressure (falling pressure)

These operating points are also called the set points of the switch.

Differential

The *differential* is the difference in pressure between the rising and falling pressure points. It can be adjustable or fixed.

Range

The *range* refers to the pressure limits within which the operating points (settings) can be adjusted. The range of the 9012G pressure switch is tied to the decreasing pressure operating point. Adding the differential to the decreasing pressure operating point determines the increasing pressure operating point.

Differential

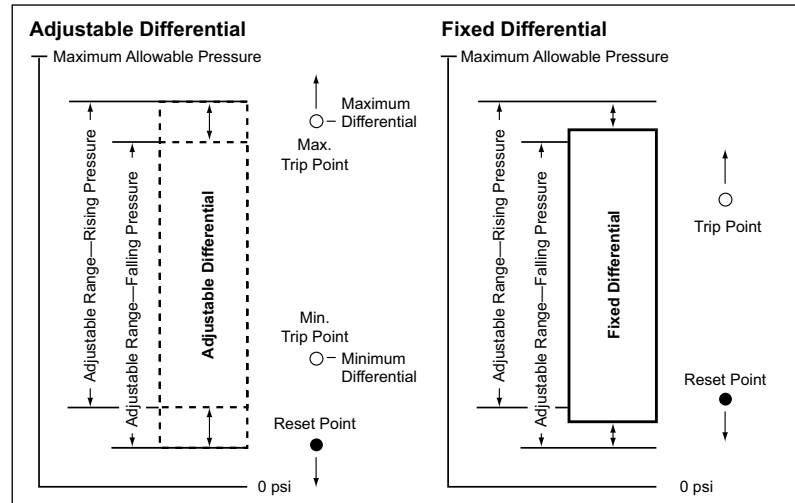

Fixed differential

To determine the operating range on rising pressure for a fixed differential switch, add the differential to the decreasing pressure operating point. For example, to determine the range on **increasing** pressure for a 9012GDW5 switch:

- Range on decreasing pressure = 3 to 150 psi
- Fixed differential = 6.0 ± 0.8 psi
- Range on increasing pressure = 9 ± 0.8 to 156 ± 0.8 psi

Adjustable differential

For adjustable differential switches, add the minimum differential to the low end of the range and the maximum differential to the high end of the range. For example, to determine the range on **increasing** pressure for a 9012GAW5:

- Range on decreasing pressure = 3 to 150 psi
- Adjustable differential = 6.0 to 30 psi
- Range on increasing pressure = 9 to 180

During the normal operating cycle, system pressure should never exceed the upper limit of the range when using a diaphragm-actuated switch. This greatly reduces the life of the diaphragm. For optimum life, operate the switch in the middle 80% of the range.

Maximum allowable pressure

Maximum allowable pressure is the pressure to which a switch can be subjected without causing a change in operating characteristics, shift in settings, or damage to the device.

System pressure surges may occur during machine startup or from valve operation. Surges are not normally detrimental to the life of a switch if the surge is within the maximum allowable pressure rating of the switch. Diaphragm-actuated switches should not be subjected to more than 10 surges per day. More frequent surges greatly reduce the life of the diaphragm.

Specifications

Environment	
Environmental specifications	
Conformity to standards	CE, IEC 60957.5.1, UL 508, CSA 3211-03
Product certifications	UL Listed and CSA certified as industrial control equipment
Protective treatment	Marine use: HT (does not apply to 9016GVG)
Fluids controlled	Air, water, hydraulic oils, gases, steam (depending on the model)
Materials	Cast aluminum enclosures (9012 NEMA 1 and 9016 GVG are stamped metal enclosure and molded cover)
Operating position	Operates in all positions
Shock resistance	50 g
Degree of protection	Depends on the model
Operating rate (operating cycles/minute)	120 operations/minute max. 9016GVG: 60 operations/minute max.
Repeat accuracy	±0.1 to ±1.0% (does not apply to 9016GVG)
Drift	±1.0% of the adjustable range over 1 million operations
Pressure connection	G1/4 (BSP) female, 1/4"-18 NPTF, or 1/2"-14 NPT
Electrical connection	1/2"-14 NPTF, Pg13.5, or ISO M20 (also, 3/4"-14 NPTF available only on NEMA 7 and 9). NEMA 1 is 1/2" conduit entry, unthreaded.

Contact arrangement

9012G and 9016G machine tool and vacuum switches (except GVG)

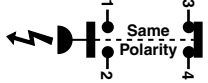
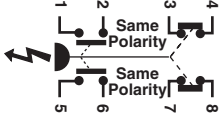
Type	Contact arrangement	Contact symbol
Single Pole Double Throw (SPDT)	1 N.O., 1 N.C.	
Double Pole Double Throw (DPDT)	2 N.O., 2 N.C.	

Snap switch contains two double-break contact elements (1 N.O., 1 N.C.) that must be used on circuits of the same polarity.

Snap switch contains two electrically separated sets of contact elements allowing use on circuits of opposite polarity. Each set contains two double-break contact elements (1 N.O. and 1 N.C.) that must be used on circuits of the same polarity.

Circuit ratings

Contacts	Continuous carrying amperes	AC—50 or 60 Hz						DC		
		Voltage (V)	Inductive 35% power factor				Resistive, 75% power factor	Voltage (V)	Inductive and resistive	
			Make		Break				Make and break amperes	
A	VA	A	VA	Make and break amperes		Single throw	Double throw			
SPDT	10	120	60	7200	6	720	6	125	0.55	0.22
	10	240	30	7200	3	720	3	250	0.27	0.11
	10	480	15	7200	1.5	720	1.5	301–600 ⁽¹⁾	0.10	—
	—	600	12	7200	1.2	720	1.2	—	—	—
DPDT	10	120	60	7200	6	720	6	125	0.22	0.22
	10	240	30	7200	3	720	3	250	0.11	0.11
	10	480	15	7200	1.5	720	1.5	600	—	—
	—	600	12	7200	1.2	720	1.2	—	—	—

⁽¹⁾ Continuous carrying ampere rating does not apply.

Acceptable wire sizes: 12–22 AWG. Recommended terminal clamp torque: 7 lb-in
Not recommended for use on circuits below 24 V, 20 mA.

Electrical Ratings—9016GVG

Voltage	AC		DC
	Single Phase	Polyphase	
110 V	2 hp	3 hp	1 hp
220 V	3 hp	5 hp	1 hp
440–550 V	5 hp	5 hp	—
32 V	—	—	0.5 hp

Note: Control Circuit Rating: A600

9012G and 9016G

Industrial pressure and vacuum switches

9012G pressure switches

Interpreting the catalog number (excluding 9016GVG)				
Use this table for interpretation only. Some combinations are not available.				
Designation		9012G	A R 2 2	
Classification		Catalog number		
Classification	Pressure Switch	9012G		
	Vacuum Switch	9016G		
Actuator Type— Differential Type	Single-Stage Machine Tool	Diaphragm, Low Pressure—Adjustable	A	
		Diaphragm, High Pressure—Adjustable	B	
		Piston—Adjustable	C	
		Diaphragm, Low Pressure—Fixed	D	
		Diaphragm, High Pressure—Fixed	E	
		Piston—Fixed	F	
	Differential-Pressure	Diaphragm, Low Pressure—Adjustable	G	
		Diaphragm, High Pressure—Adjustable	H	
		Piston—Adjustable	J	
	Dual-Stage	Diaphragm, Low Pressure—Adjustable	K	
		Diaphragm, High Pressure—Adjustable	L	
		Piston—Adjustable	M	
	Single-Stage Industrial	Diaphragm, Low Pressure—Adjustable	N	
		Diaphragm, High Pressure—Adjustable	P	
		Piston—Adjustable	Q	
		Diaphragm, Low Pressure—Fixed	R	
		Diaphragm, High Pressure—Fixed	S	
		Piston—Fixed	T	
	Enclosure, NEMA Type	1	G	
		Open	O	
7, 9		R		
4, 4X, 13		W		
Threads	1/4"-18 NPTF	blank		
	Metric	M		
Contacts	Single-pole, double-throw	blank		
	Double-pole, double-throw	2		
Pressure Range (psi)	Diaphragm	0.2–10	1	
		1–40	2	
		Single or Dual Stage, Low Pressure	1.5–75	4
		3–150	5	
		5–250	6	
		13–425	1	
	Single or Dual Stage, High Pressure	20–675	2	
		Differential-Pressure, Low Pressure	0–75	1
		0–175	4	
	Differential-Pressure, High Pressure	0–500	1	
		20–1000	1	
		Piston	Single or Dual Stage	90–2900
	170–5600		3	
	270–9000		4	
	Differential-Pressure		0–5000	1
	Vacuum (inHg)	Diaphragm	Single Stage, Low Pressure	0–28
0–25			2	
Options	Factory modifications and accessories		See tables on pages 8/91, 8/93 and 99.	

9012G machine tool pressure switches for single-stage operation						
Pressure range (psi)—Contacts change on decreasing pressure						
Actuator	Switch style	Range (psi)	Fixed differential	Adjustable differential	Pressure code	
Diaphragm	Single or Dual Stage, Low Pressure	0.2–10	0.6±0.1	0.6–2	1	
		1–40	1.6±0.4	1.6–8	2	
		1.5–75	3.0±0.5	3.5–15	4	
		3–150	6.0±0.8	6.0–30.0	5	
		5–250	10.0±1.5	10.0–49	6	
	Single or Dual Stage, High Pressure	13–425	16±3.5	16–90	1	
		20–675	27±5	27–130	2	
		Differential-Pressure, Low Pressure	0–75	0.25±10	0.25–10	1
		0–175	—	0.5–36	4	
		Differential-Pressure, High Pressure	0–500	—	3–175	1
Piston	Single or Dual Stage	20–1000	89±18	89–200	1	
		90–2900	255±30	255–560	2	
		170–5600	578±110	578–1260	3	
		270–9000	788±140	788–1900	4	
	Differential-Pressure	0–5000	—	15–825	1	

The 9012G single-stage pressure switches are control-circuit rated devices. These switches are used in pneumatic or hydraulic systems on a wide variety of machine and process applications to protect the equipment. They either control or monitor the system pressure.

Selection and specifications—9012G pressure switches



9012GDW1

Single-Stage Operation

Class 9012 single-stage pressure switches are control circuit rated devices used in pneumatic or hydraulic systems on a wide variety of machine and process applications to protect the equipment and control or monitor the system pressure.

- Type G machine tool switches are available with NEMA 4, 4X, and 13 (IEC IP66) enclosure ratings.
- The NEMA 7 and 9 devices are UL listed for use in the following hazardous locations: Class I, Divisions 1 and 2, Groups C and D; and Class II, Divisions 1 and 2, Groups E, F, and G.
- NEMA 4, 4X, and 13 devices are suitable for use in Class I, Division 2, Groups A, B, C, and D hazardous locations or nonhazardous locations only.
- Enclosure materials are cast aluminum.
- To ensure repeatability and minimize setting drift, pressure settings should fall within the middle 80 percent of the pressure range.

**Fixed differential
NEMA 4, 4X, 13 Enclosure**

UL Listed and CSA Certified as Industrial Control Equipment

Range on decreasing pressure psig	Approximate differential at mid-range, psig ⁽¹⁾	Maximum allowable pressure, psig	Class 9012 Type	
			SPDT	DPDT
Diaphragm actuated—Nitrile diaphragm, zinc plated steel housing				
0.2–10	0.6 ± 0.1	100	GDW1	GDW21
1–40	1.6 ± 0.4	100	GDW2	GDW22
1.5–75	3.0 ± 0.5	240	GDW4	GDW24
3–150	6.0 ± 0.8	475	GDW5	GDW25
5–250	10.0 ± 1.5	750	GDW6	GDW26
13–425	16 ± 3.5	850	GEW1	GEW21
20–675	27 ± 5	2000	GEW2	GEW22
Piston actuated—#440 stainless steel piston #303 stainless steel housing, Viton® fluorocarbon diaphragm and O-ring, Teflon® retaining ring				
20–1000	59 ± 9	10,000	GFW1	GFW21
90–2900	170 ± 15	15,000	GFW2	GFW22
170–5600	289 ± 55	20,000	GFW3	GFW23
270–9000	495 ± 70	25,000	GFW4	GFW24

Specifications

Fluids controlled	Air, water, hydraulic oils, gases, steam (depending on the model)	
Pressure connection	1/4"-18 NPTF is standard. For metric threads, add M after the W on all types. (2) Other options are available (see page 8/91).	
Weight (approximate)	3 lb (1.36 kg)	
Voltage limits	600 V	
Continuous current	10 A	
Electrical connections	1/2"-14 NPTF (standard), For Pg 13.5, or ISO M20, see footnote (2).	
Standards/Ratings	CE, IEC 60957.5.1, UL 508, CSA 3211-03. UL Marine Listed for use on ships/vessels greater than 65 ft long where ignition protection is not required.	
Temperature ratings	Minimum	Maximum
Ambient	-23 °C (-10 °F)	+85 °C (+185 °F)
	Diaphragm	-40 °C (-40 °F)
Media	Piston	+120 °C (+250 °F)
	All with Form Q4	-26 °C (-15 °F)

Operating curves

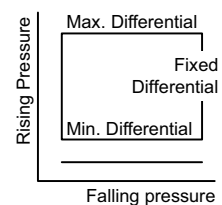

Contact blocks

1 N.O., 1 N.C.

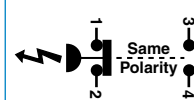

2 N.O., 2 N.C.

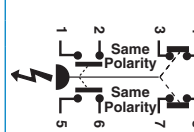

Connection

Form H17

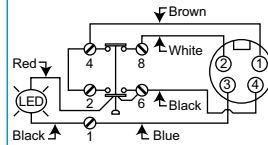

Form H10

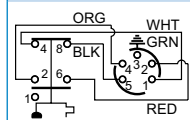

Form H11

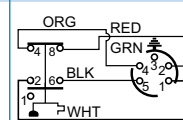

SPDT snap switches contain two double-break contact elements (1 N.O., 1 N.C.) that must be used on circuits of the same polarity. **DPDT** snap switches contain two electrically separated sets of contact elements allowing use on circuits of opposite polarity. Each set contains two double-break contact elements (1 N.O., 1 N.C.) that must be used on circuits of the same polarity.

Acceptable wire sizes: 12–22 AWG **Recommended terminal clamp torque:** 7 lb-in

(1) The differential adds to the range setting and determines the operating point on rising pressure.
 (2) To order a Pg13.5 electrical conduit entry and a 1/4"-19 BSP pressure connection, add M12 to the end of the catalog number, as well as adding "M" after "W" for metric threads. For example:
 9012GAW1 = 1/2" NPT electrical conduit entry
 9012GAWM1 = 20 x 1.5 mm electrical conduit entry and 1/4"-19 BSP pressure connection
 9012GAWM1M12 = Pg13.5 electrical conduit entry and 1/4"-19 BSP pressure connection

9012G and 9016G

Industrial pressure and vacuum switches
9012G machine tool pressure switches



9012GDR

Fixed Differential
NEMA 7 & 9 Enclosure, Class I & II, Division 1 & 2, Groups C, D, E, F, G
UL Listed as Industrial Control Equipment

Range on Decreasing Pressure psig	Approximate Differential at Mid Range psig ⁽¹⁾	Maximum Allowable Pressure, psig	Class 9012 Type	
			SPDT	DPDT
Diaphragm Actuated—Nitrile Diaphragm, Zinc Plated Steel Housing				
0.2–10	1.0 ± 0.1	100	GDR1	GDR21
1–40	2.4 ± 0.8	100	GDR2	GDR22
1.5–75	4.5 ± 1	240	GDR4	GDR24
3–150	9 ± 1.5	475	GDR5	GDR25
5–250	15 ± 3	750	GDR6	GDR26
13–425	25 ± 7	850	GER1	GER21
20–675	41 ± 10	2000	GER2	GER22

Piston Actuated—#440 Stainless Steel Piston.
#303 Stainless Steel Housing, Viton® Fluorocarbon Diaphragm and O-ring, Teflon® Retaining Ring

20–1000	89 ± 18	10,000	GFR1	GFR21
90–2900	255 ± 30	15,000	GFR2	GFR22
170–5600	578 ± 110	20,000	GFR3	GFR23
270–9000	788 ± 140	25,000	GFR4	GFR24

Specifications

Fluids Controlled	Air, water, hydraulic oils, gases, steam (depending on the model)
Pressure Connection	1/4"-18 NPTF (standard) or 1/2"-14 NPT. See page 8/91.
Weight (approximate)	10 lb (4.54 kg)
Voltage Limits	600 V
Continuous Current	10 A
Electrical Connections	1/2"-14 NPTF, 3/4"-14 NPTF
Standards/Ratings	CE, IEC 60957.5.1, UL 508, CSA 3211-03. UL Marine Listed for use on vessels greater than 65 ft long where ignition protection is required.

Temperature Ratings		Minimum	Maximum
Ambient		-23 °C (-10 °F)	+85 °C (+185 °F)
	Diaphragm	-40 °C (-40 °F)	
Media	Piston	-26 °C (-15 °F)	+120 °C (+250 °F)
	All with Form Q4	-26 °C (-15 °F)	

Operating Curves **Contact Blocks** **Connection**

1 N.O., 1 N.C. Same Polarity

2 N.O., 2 N.C. Same Polarity

Form H17

SPDT snap switches contain two double-break contact elements (1 N.O., 1 N.C.) that must be used on circuits of the same polarity. **DPDT** snap switches contain two electrically separated sets of contact elements allowing use on circuits of opposite polarity. Each set contains two double-break contact elements (1 N.O., 1 N.C.) that must be used on circuits of the same polarity.

Form H10

Form H11

Acceptable Wire Sizes: 12–22 AWG **Recommended Terminal Clamp Torque:** 7 lb-in

⁽¹⁾ The differential adds to the range setting and determines the operating point on rising pressure.

NOTE: When pressure settings of the switches must be factory set (Form Y1), and only one setting is identified, specify whether this setting is on increasing or decreasing pressure.



File E12443 CCN NOWT Haz. Loc., G•R
File E12158 CCN NKPZ G•W, G•O, G•G
File E12158 CCN NTHT Marine Use, G•W



File LR 25490 Class 3211-03 G•W, G•O, G•G
File LR 26817 Class 3218-02 G•R



9012G and 9016G

Industrial pressure and vacuum switches
9012G machine tool pressure switches



9012GAW1

**Adjustable Differential
NEMA 4, 4X, 13 Enclosure
UL Listed and CSA Certified as Industrial Control Equipment**

Range on Decreasing Pressure, psig	Adjustable Differential ⁽¹⁾ Approximate at Mid Range	Maximum Allowable Pressure, psig	Class 9012 Type	
			SPDT	DPDT
Diaphragm Actuated—Nitrile Diaphragm, Zinc Plated Steel Housing				
0.2–10	0.7–2	100	GAW1	GAW21
1–40	2.4–8	100	GAW2	GAW22
1.5–75	3.9–15	240	GAW4	GAW24
3–150	6.6–30	475	GAW5	GAW25
5–250	11–49	750	GAW6	GAW26
13–425	20–82	850	GBW1	GBW21
20–675	35–130	2000	GBW2	GBW22

Piston Actuated—#440 Stainless Steel Piston. #303 Stainless Steel Housing, Viton® Fluorocarbon Diaphragm and O-ring, Teflon® Retaining Ring				
20–1000	65–200	10,000	GCW1	GCW21
90–2900	187–560	15,000	GCW2	GCW22
170–5600	425–1050	20,000	GCW3	GCW23
270–9000	580–1500	25,000	GCW4	GCW24

Specifications

Fluids Controlled	Air, water, hydraulic oils, gases, steam (depending on the model)
Pressure Connection	1/4"-18 NPTF is standard. For metric threads (G1/4 BSP female pressure connection and M20 electrical connection), add M after the W in the catalog number. For additional pressure connections, see page 8/91. ⁽¹⁾
Weight (approximate)	3 lb (1.36 kg)
Voltage Limits	600 V
Continuous Current	10 A
Electrical Connections	1/2"-14 NPTF is standard. For metric threads (G1/4 BSP female pressure connection and M20 electrical connection), add M after the W in the catalog number. ⁽²⁾
Standards/Ratings	CE, IEC 60957.5.1, UL 508, CSA 3211-03. UL Marine Listed for use on ships/vessels greater than 65 ft long where ignition protection is not required.

	Minimum	Maximum
	Ambient	-23 °C (-10 °F)
Diaphragm	-40 °C (-40 °F)	
Media Piston	-26 °C (-15 °F)	+120 °C (+250 °F)
All with Form Q4	-26 °C (-15 °F)	

Operating Curves **Contact Blocks** **Connection**

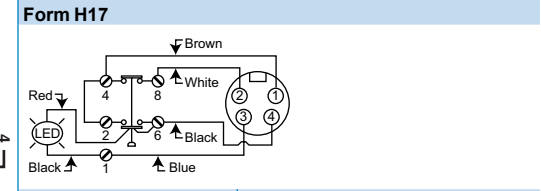
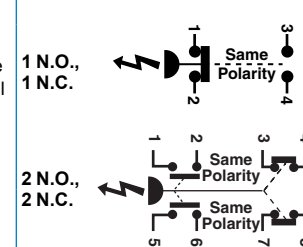
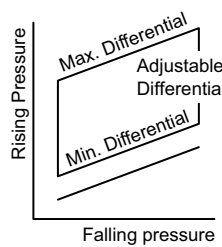

SPDT snap switches contain two double-break contact elements (1 N.O., 1 N.C.) that must be used on circuits of the same polarity.
DPDT snap switches contain two electrically separated sets of contact elements allowing use on circuits of opposite polarity. Each set contains two double-break contact elements (1 N.O., 1 N.C.) that must be used on circuits of the same polarity.

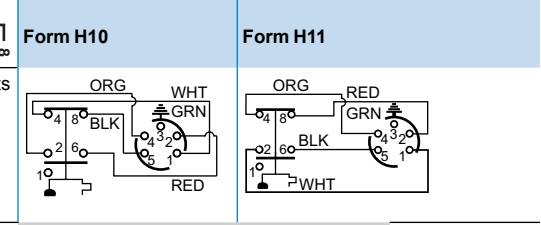

Acceptable Wire Sizes: 12–22 AWG **Recommended Terminal Clamp Torque:** 7 lb-in

⁽¹⁾ The differential adds to the range setting and determines the operating point on rising pressure.
⁽²⁾ To order a Pg13.5 electrical conduit entry and a 1/4"-19 BSP pressure connection, add M12 to the end of the catalog number, as well as adding "M" after "W" for metric threads. For example:
9012GAW1 = 1/2" NPT electrical conduit entry
9012GAWM1 = 20 x 1.5 mm electrical conduit entry and 1/4"-19 BSP pressure connection
9012GAWM1M12 = Pg13.5 electrical conduit entry and 1/4"-19 BSP pressure connection

9012G and 9016G

Industrial pressure and vacuum switches
9012G machine tool pressure switches



9012GAR

Adjustable Differential
NEMA 7 & 9 Enclosure, Class I & II, Division 1 & 2, Groups C, D, E, F, G
UL Listed as Industrial Control Equipment

Range on Decreasing Pressure, psig	Adjustable Differential ⁽¹⁾ Approximate at Mid Range	Maximum Allowable Pressure, psig	Class 9012 Type	
			SPDT	DPDT
Diaphragm Actuated—Nitrile Diaphragm, Zinc Plated Steel Housing				
0.2–10	1.0–2	100	GAR1	GAR21
1–40	4–8	100	GAR2	GAR22
1.5–75	8–15	240	GAR4	GAR24
3–150	16–30	475	GAR5	GAR25
5–250	23–49	750	GAR6	GAR26
13–425	36–82	850	GBR1	GBR21
20–675	65–130	2000	GBR2	GBR22

Piston Actuated—#440 Stainless Steel Piston. #303 Stainless Steel Housing, Viton® Fluorocarbon Diaphragm and O-ring, Teflon® Retaining Ring				
20–1000	98–200	10,000	GCR1	GCR21
90–2900	281–560	15,000	GCR2	GCR22
170–5600	638–1050	20,000	GCR3	GCR23
270–9000	870–1500	25,000	GCR4	GCR24

Specifications

Fluids Controlled	Air, water, hydraulic oils, gases, steam (depending on the model)
Pressure Connection	1/4"-18 NPTF (standard) or 1/2"-14 NPT. See page 8/91.
Weight (approximate)	10 lb (4.54 kg)
Voltage Limits	600 V
Continuous Current	10 A
Electrical Connections	1/2"-14 NPTF, 3/4"-14 NPTF

Standards/Ratings CE, IEC 60957.5.1, UL 508, CSA 3211-03. UL Marine Listed for use on vessels longer than 65 ft where ignition protection is required.

Temperature Ratings	Minimum	Maximum
Ambient	-23 °C (-10 °F)	+85 °C (+185 °F)
Diaphragm	-40 °C (-40 °F)	
Media	-26 °C (-15 °F)	+120 °C (+250 °F)
Piston	-26 °C (-15 °F)	
All with Form Q4	-26 °C (-15 °F)	

Operating Curves

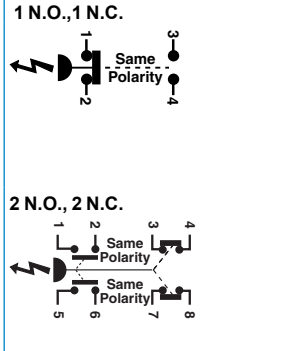
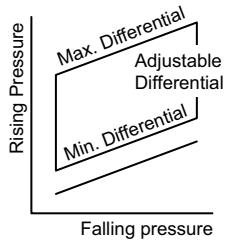

Connection

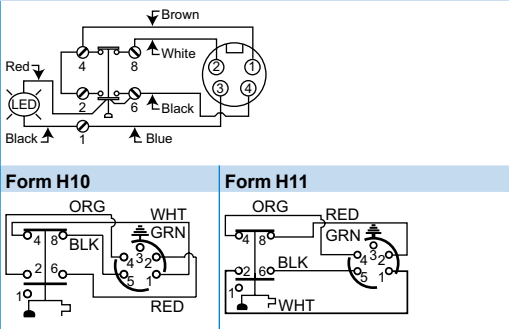

SPDT snap switches contain two double-break contact elements (1 N.O., 1 N.C.) that must be used on circuits of the same polarity. **DPDT** snap switches contain two electrically separated sets of contact elements allowing use on circuits of opposite polarity. Each set contains two double-break contact elements (1 N.O., 1 N.C.) that must be used on circuits of the same polarity.

Acceptable Wire Sizes:	12–22 AWG	Recommended Terminal Clamp Torque:	7 lb-in
-------------------------------	-----------	---	---------

⁽¹⁾ The differential adds to the range setting and determines the operating point on rising pressure.



File E12443 CCN NOWT Haz. Loc., G•R
File E12158 CCN NKPZ G•W, G•O, G•G
File E12158 CCN NTHH Marine Use, G•W



File LR 25490 Class 3211-03 G•W, G•O, G•G
File LR 26817 Class 3218-02 G•R



9012G and 9016G

Industrial pressure and vacuum switches

9012G pressure switches for differential-pressure operation



9012GJW1

Differential-Pressure Operation

Pressure switches for differential-pressure operation are used to monitor the change in the difference between two pressures. The 9012G differential-pressure switches are unidirectional devices and are used in applications to signal that a predetermined pressure difference has been reached as a result of a widening or increasing difference between the two pressures. They can also be used in applications to signal that a predetermined pressure difference has been reached as a result of a narrowing or decreasing difference between the two pressures.

NEMA 4, 4X, and 13 devices are suitable for use in Class I, Division 2, Groups A, B, C, and D hazardous locations or nonhazardous locations only.

Adjustable differential

NEMA 4, 4X, 13 Enclosures

UL Listed and CSA Certified as Industrial Control Equipment

Working Pressure Range on decreasing X (upper) actuator	Adjustable Difference on Decreasing Pressure (Adds to working pressure) Y (lower) actuator	Adjustable Differential Actuates on increasing pressure (adds to adjustable difference)	Maximum Allowable Pressure	Class 9012 Type	
				SPDT	DPDT

Diaphragm Actuated—Nitrile Diaphragm, Zinc Plated Steel Housing

0–75	0.25–10	1–2	100	GGW1	GGW21
0–175	0.5–36	5.6–15	240	GGW4	GGW24
0–500	3–175	26–90	850	GHW1	GHW21

Piston Actuated—#440 Stainless Steel Piston.

#303 Stainless Steel Housing, Viton® Fluorocarbon Diaphragm and O-ring, Teflon® Retaining Ring

0–5000	15–825	97–200	7500	GJW1	GJW21
--------	--------	--------	------	------	-------

Specifications

Fluids Controlled	Air, water, hydraulic oils, gases, steam (depending on the model)	
Pressure Connection	1/4"-18 NPTF is standard. For metric threads (G1/4 BSP female pressure connection and M20 electrical connection), add M after the W in the catalog number. For other options, see page 8/91. ⁽¹⁾	
Weight (approximate)	3 lb (1.36 kg)	
Voltage Limits	600 V	
Continuous Current	10 A	
Electrical Connections	1/2"-14 NPTF (standard), For Pg 13.5, or ISO M20, see footnote (2) on page 8/87.	
Standards/Ratings	CE, IEC 60957.5.1, UL 508, CSA 3211-03. UL Marine Listed for use on vessels greater than 65 ft long where ignition protection is not required.	
Temperature Ratings	Minimum	Maximum
Ambient	–23 °C (–10 °F)	+85 °C (+185 °F)
Diaphragm	–40 °C (–40 °F)	
Media	Piston	+120 °C (+250 °F)
	All with Form Q4	–26 °C (–15 °F)

Operating Curves

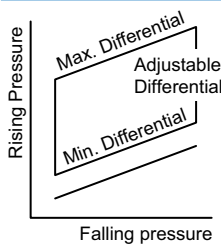

Contact Blocks

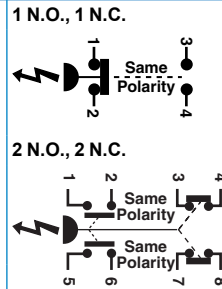

Connection

Form H17

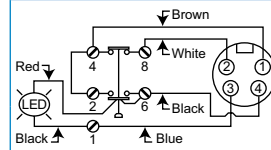

Form H10

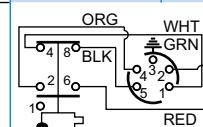

Form H11

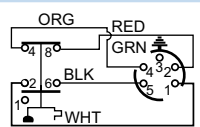

SPDT snap switches contain two double-break contact elements (1 N.O., 1 N.C.) that must be used on circuits of the same polarity.
DPDT snap switches contain two electrically separated sets of contact elements allowing use on circuits of opposite polarity. Each set contains two double-break contact elements (1 N.O., 1 N.C.) that must be used on circuits of the same polarity.

Acceptable Wire Sizes: 12–22 AWG

Recommended Terminal Clamp Torque: 7 lb-in



File E12158 CCN NKPZ
File E12158 CCN NTHH - Marine Use



File LR25490 Class 3211-03





9012GKW1

Dual-Stage Operation

The **9012G dual-stage pressure switches** are designed for use in applications where two separate pressure operations must be controlled by a single pressure monitoring device. These controls are most commonly used where dual functions are required or in sequencing applications such as alarm shutdowns. The spread between the two stages is adjustable, but the differential between the high (rising) and low (falling) operating points of each stage is fixed.

NEMA 4, 4X, and 13 devices are suitable for use in Class I, Division 2, Groups A, B, C, and D hazardous locations or nonhazardous locations only.

Fixed Differential NEMA 4, 4X, 13 Enclosure UL Listed and CSA Certified as Industrial Control Equipment

Range Setting Pressure limits between which Stage 1 can be adjusted to operate on decreasing pressure	Adjustable Spread Add to the range setting to obtain the decreasing operating point of Stage 2	Fixed Differential Add to the low operating point to obtain the approximate high operating point for each stage		Maximum Allowable Pressure	SPDT Each Stage Type
		Stage 1	Stage 2		
Diaphragm Actuated—Nitrile Diaphragm, Zinc Plated Steel Housing					
0.2–10	1.1–5	1.0 ± 0.2	1.5 ± 0.4	100	GKW1
1–40	4.4–20	4.0 ± 1.0	6.0 ± 1.5	100	GKW2
1.5–75	6.6–30	6.0 ± 1.5	8.0 ± 2.0	240	GKW4
3–150	13.2–75	8.0 ± 2.0	12 ± 3	475	GKW5
5–250	24.2–110	14 ± 3	21 ± 5	750	GKW6
13–425	44–180	20 ± 4	30 ± 7.5	850	GLW1
20–675	50–250	30 ± 6	45 ± 11	2000	GLW2
Piston Actuated—#440 Stainless Steel Piston. #303 Stainless Steel Housing, Viton® Fluorocarbon Diaphragm and O-ring, Teflon® Retaining Ring					
20–1000	72–300	50 ± 10	75 ± 19	10,000	GMW1
90–2900	176–800	140 ± 30	210 ± 52	15,000	GMW2
170–5600	360–1700	275 ± 60	400 ± 100	20,000	GMW3
270–9000	550–2500	400 ± 80	800 ± 150	25,000	GMW4

Specifications

Fluids Controlled	Air, water, hydraulic oils, gases, steam (depending on the model)	
Pressure Connection	1/4"-18 NPTF is standard. For metric threads, add M after the W on all types. Other options are available (see page 8/91). ⁽¹⁾	
Weight (approximate)	3 lb (1.36 kg)	
Voltage Limits	600 V	
Continuous Current	10 A	
Electrical Connections	1/2"-14 NPTF (standard), For Pg 13.5, or ISO M20, see footnote (2) on page 8/87.	
Standards/Ratings	CE, IEC 60957.5.1, UL 508, CSA 3211-03. UL Marine Listed for use on vessels greater than 65 ft long where ignition protection is not required.	
Temperature Ratings	Minimum	Maximum
Ambient	-23 °C (-10 °F)	+85 °C (+185 °F)
	Diaphragm	-40 °C (-40 °F)
Media	Piston	+120 °C (+250 °F)
	All with Form Q4	-26 °C (-15 °F)

Operating Curves

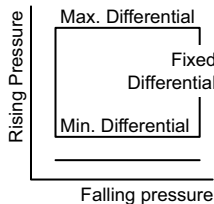

Contact Blocks

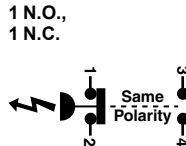

Acceptable Wire Sizes:
12–22 AWG

Recommended Terminal Clamp Torque:
7 lb-in



File E12158 CCN NKPZ
File E12158 CCN NTHT - Marine Use



File LR25490 Class 3211-03



Wiring Diagrams for Receptacles and Connectors—Factory Modifications (Forms)—see page 8/91.

Prewired 5-pin male receptacle

Form H10

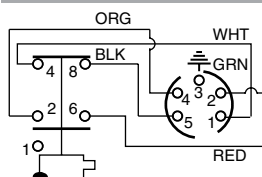

Form H11

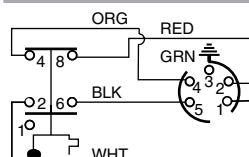

Micro connector, 4-pin, for 24 Vdc pilot light

Form H17

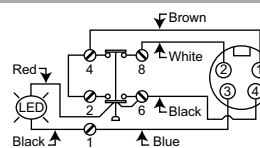

Modifications, Renewal Parts, and Accessories

9012G Machine Tool Factory Modifications (Forms)

Modification	Applies to	Form	
Lock on rising pressure, manual reset only	Available on GDW, GDWM, GEW, GEWM, GFW, GFWM only	E3	
120 Vac or Vdc neon pilot light	Available on all GAW–GMW and GAWM–GFWM	clear lens G17 red lens G18	
	For pilot light conversion kits: See 9998PC306–308	clear lens G21 red lens G22	
24 Vdc only LED	Class 9012 GAW–GMW and GAWM–GFWM, or Class 9016 GAW	G23	
SPDT snap switch rated 1.1 A at 125 Vdc (minimum differential doubles)	Available on GAR–GFR, GAW–GJW, and GAWM–GFWM	H3	
Prewired 5-pin male receptacle: Brad Harrison #41310 or interchangeable Crouse-Hinds receptacle at our convenience. For use with Brad Harrison female portable plug #41306, 41307, 41308 or equal	Available on GAW–GJW single pole devices only. See wiring diagrams on page 8/90.	H10 or H11	
Micro connector, 4-pin, for 24 Vdc pilot light (see diagram on page 8/90)	G•W (single pole only), except GAW2 and Form B2.	H17	
External range adjustment with knob	GAW–GFW, GAWM–GFWM, and GKW–GMW	K	
with range scale window	Slotted for screwdriver	GAW–GFW, GAWM–GFWM, and GKW–GMW	
Pg 13.5 conduit thread and 1/4"-19 BSP pressure connection	GAW–GFW and GKW–GMW	M12	
#316 stainless steel flange	Standard nitrile diaphragm	GAR, GBR, GDR, GER, GAW, GBW, GDW, GEW, GGW, GHW, GAWM, GBWM, GDWM, GEWM, GKW, GLW, except Types 1 and 21	Q1
	Ethylene propylene diaphragm	Available on all GGW, GHW except GGW-1, 21. Available on all GAR, GBR, GDR, GER, GAW, GBW, GDW, GEW, GAWM, GBWM, GDWM, GEWM, GKW, GLW, except Types 1 and 21	Q3
	Viton® fluorocarbon diaphragm	GAR, GAW, GBR, GBW, GDR, GDW, GER, GEW, GGW, GHW, GAWM, GBWM, GDWM, GEWM, GKW, GLW, except Types 1 and 21	Q4
Range scale window (standard with Forms K and K1)	GAW–GMW, GAWM–GFWM	V1	
Special factory setting specified (If indicating only one special setting, specify whether this setting is on increasing or decreasing pressure.)	All 9012G	Y1	
Pressure connection	1/4"-18 NPT external thread	GAR, GAW, GDR, GDW, GGW, GKW	Z
	Not available in combination with Forms Q1, Q3, Q4	1/2"-14 NPT external thread, 1/4"-18 NPTF internal thread	GAR, GAW, GDR, GDW, GGW, GKW
	7/16"-20 UNF-2B internal thread	GAR–GFR; GAW–GMW	Z18

9012G Pressure Switches, Factory Modifications (Forms) for Renewal Parts Kits, Class 9998

For suffixes for renewal parts kits, see the table below.

Modification	Applies to Parts Kit Type	Form	
SPDT snap switch rated 1.1 A at 125 Vdc (minimum differential doubles)	PC313	H3	
Standard nitrile diaphragm	PC177–179, PC268, 269	Q1	
	PC265–267		
#316 stainless steel flange	PC177–178, PC268, 269	Q3	
	PC266, 267		
Viton® fluorocarbon diaphragm	PC177–178, PC268, 269	Q4	
	PC265–267		
Pressure connection	1/4"-18 NPT external thread	PC265–269	Z
	1/2"-14 NPT external thread, 1/4"-18 NPTF internal thread	PC265–269	Z16
	7/16"-20 UNF-2B internal thread	PC177, 178, PC265–273	Z18

Renewal Parts Kits, Class 9998, for Class 9012 and 9016 Devices

Description	Equipment To Be Serviced	Parts Kit Type
Actuator assembly	9012GA, GD, GG, GK, GN, GR 5, 25, 55 Series C only	PC268 (1)
	9012GA, GD, GG, GK, GN, GR 6, 26, 36, 46, 56 Series C only	PC269 (1)
	9012GB, GE, GH1, 21, 31, 41, 51; GL, GP, GS1	PC177 (1)
	9012GB, GE, GH2, 22, 32, 42, 52; GL, GP, GS2	PC178 (1)
Diaphragm assembly	9012GA, GD, GN, GR1, 21 Series C only	PC265 (1)
	9012GA, GD, GG, GK, GN, GR 2, 3, 22, 52 Series C only	PC266 (1)
	9012GA, GD, GG, GK, GN, GR4, 24, 54 Series C only	PC267 (1)
	9016 GAW-1, 21	PC233
Gasket kit	Contains all replaceable gaskets for all 9012 Open, NEMA 1, 4, 4X, 13	PC184
Pilot light	9012, 9016G Forms G7, G8, G9, G10, G21, G22; 24 Volts DC	PC305
Piston assembly	9012GC, GF, GJ, GQ, GT1, 21, 31, 41, 51 Series C only	PC270 (1)
	9012GC, GF, GJ, GQ, GT2, 22, 32, 42, 52 Series C only	PC271 (1)
	9012GC, GF, GQ, GT4, 24, 34, 44, 54 Series C only	PC273 (1)
Snap switch	SPDT, for 9012GA, GB, GC, GD, GE, GF, GG, GH, GJ Single Pole; Except Forms E2, E3, E4, H3: Series C only	PC313 (1)
	DPDT, 9012GA, GB, GC, GD, GE, GF, GG, GH, GJ Double Pole; Except Forms E2, E3, H6, H7: Series C only	PC314 (1)

(1) If one of these Form designations appears on the pressure switch nameplate, the 9998 PC number must be completed by adding that same Form suffix from the table above, and the Form price added to the kit price.

Accessories

Class 9049 Accessories for 9012G Pressure Switches

Description	Type
Stainless steel surge reducer for use on oils, coolants, and hydraulic fluids (not recommended for air or water)	A26S



9012GRG5

**Fixed Differential
Open Type or NEMA 1 Enclosure
UL Listed and CSA Certified as Industrial Control Equipment**

Range on Decreasing Pressure, psig	Approximate Differential ⁽¹⁾ At Mid Range, psig	Maximum Allowable Pressure, psig	Class 9012 Type	
			Open Type	NEMA 1

Diaphragm Actuated—Nitrile Diaphragm, Zinc Plated Steel Housing

0.2–10	0.4 ± 0.1	100	GRO1	GRG1
1–40	1.2 ± 0.3	100	GRO3	GRG3
1.5–75	2.2 ± 0.4	240	GRO4	GRG4
3–150	4.2 ± 1	475	GRO5	GRG5
5–250	7.4 ± 2	750	GRO6	GRG6
13–425	13 ± 3	850	GSO1	GSG1
20–675	19 ± 5	2000	GSO2	GSG2

**Piston Actuated—#440 Stainless Steel Piston.
#303 Stainless Steel Housing, Viton® Fluorocarbon Diaphragm and O-Ring, Teflon® Retaining Ring**

20–1000	49 ± 10	10,000	GTO1	GTG1
90–2900	141 ± 15	15,000	GTO2	GTG2
170–5600	200 ± 40	20,000	GTO3	GTG3
270–9000	350 ± 45	25,000	GTO4	GTG4

Specifications

Fluids Controlled	Air, water, hydraulic oils, gases, steam (depending on the model)		
Pressure Connection	1/4"-18 NPTF (standard), 1/2"-14 NPT, or 7/16"-20 UNF-2B. See Forms table on page 8/93.		
Weight (approximate)	Type 1: 2 lb (0.91 kg); Open: 1.7 lb (0.77)		
Voltage Limits	600 V		
Continuous Current	10 A		
Electrical Connections	1/2" conduit entry, unthreaded		
Standards/Ratings	CE, IEC 60957.5.1, UL 508, CSA 3211-03		
Temperature Ratings	Minimum	Maximum	
Ambient	-23 °C (-10 °F)	+85 °C (+185 °F)	
Media	Diaphragm	-40 °C (-40 °F)	
	Piston	-26 °C (-15 °F)	
	All with Form Q4	-26 °C (-15 °F)	
		+120 °C (+250 °F)	

Operating Curves

	Contact Blocks SPDT Form C contacts 	Acceptable Wire Sizes: 12–22 AWG Recommended Terminal Clamp Torque: 7 lb-in

⁽¹⁾ Determines the operating point on rising pressure.





9012GNO5



9012GQO2



9012GNG1

Adjustable Differential
Open Type or NEMA 1 Enclosure
UL Listed and CSA Certified as Industrial Control Equipment

Range on Decreasing Pressure psig	Approximate Mid Range ⁽¹⁾ Differential (adds to the decreasing set point)	Maximum Allowable Pressure psig	Class 9012 Type	
			Open Type	NEMA 1
Diaphragm Actuated—Nitrile Diaphragm, Zinc Plated Steel Housing				
0.2–10	0.6–1.0	100	GNO1	GNG1
1–40	1.6–5.0	100	GNO3	GNG3
1.5–75	2.5–6.5	240	GNO4	GNG4
3–150	4.8–13	475	GNO5	GNG5
5–250	8.5–20.5	750	GNO6	GNG6
13–425	20–41	850	GPO1	GPG1
20–675	35–66	2000	GPO2	GPG2

Piston Actuated—#440 Stainless Steel Piston.
#303 Stainless Steel Housing, Viton® Fluorocarbon Diaphragm and O-Ring, Teflon® Retaining Ring

20–1000	56–98	10,000	GQO1	GQG1
90–2900	162–308	15,000	GQO2	GQG2
170–5600	355–563	20,000	GQO3	GQG3
270–9000	481–1050	25,000	GQO4	GQG4

Specifications

Fluids Controlled	Air, water, hydraulic oils, gases, steam (depending on the model)
Pressure Connection	1/4"-18 NPTF (standard), G1/4 (BSP) female, or 1/2"-14 NPT. See Forms in the table below.
Weight (approximate)	Type 1: 2 lb (0.91 kg); Open: 1.7 lb (0.77)
Voltage Limits	600 V
Continuous Current	10 A
Electrical Connections	1/2" conduit entry, unthreaded
Standards/Ratings	CE, IEC 60957.5.1, UL 508, CSA 3211-03

	Temperature Ratings	
	Minimum	Maximum
Ambient	-23 °C (-10 °F)	+85 °C (+185 °F)
Diaphragm	-40 °C (-40 °F)	
Media	-26 °C (-15 °F)	+120 °C (+250 °F)
All with Form Q4	-26 °C (-15 °F)	

Operating Curves **Contact Blocks**

SPDT Form C contacts

Acceptable Wire Sizes:
12–22 AWG

Recommended Terminal Clamp Torque:
7 lb-in

⁽¹⁾ Determines the operating point on rising pressure.

Factory Modifications (Forms) for 9012G Pressure Switches, Open Type or NEMA 1
UL Listed and CSA Certified as Industrial Control Equipment

Modification	Applies to	Form	
Diaphragm	Standard Nitrile in #316 stainless steel housing	GNG, GNO, GPG, GPO, GRG, GRO, GSG, GSO	Q1
	Ethylene propylene in #316 stainless steel housing	Not available on GNG, GNO, GRG, GRO1. Available on all other GNG, GNO, GPG, GPO, GRG, GRO, GSG, GSO	Q3
	Viton® fluorocarbon in #316 stainless steel housing	GNG, GNO, GPG, GPO, GRG, GRO, GSG, GSO	Q4
Pressure connection	1/4"-18 NPT external thread	GNG, GNO, GRG, GRO	Z
	1/2"-14 NPT external thread, 1/4"-18 NPTF internal thread. Standard actuator only.	GNG, GNO, GRG, GRO	Z16
	7/16"-20 UNF-2B internal thread	GNG, GNO, GPG, GPO, GQG, GQO, GRG, GRO, GSG, GSO, GTG, GTO	Z18

9012G and 9016G

Industrial pressure and vacuum switches
9016G vacuum switches
Control applications

Selection and Specifications—9016G Vacuum Switches



9016GAW2



9016GAR1

9016GAW Switches for Sensitive Control Applications

9016GAW vacuum switches have double throw contacts. Normally open and normally closed circuits allow the use of these controls for standard or reverse action applications.

Standard controls can be mounted from the front using the bracket provided. Two mounting screws are required for firm attachment to any smooth, flat surface. Allowance must be made for flange projection.

Controls with the Form F modification include two mounting feet with 9/32" mounting holes on 3–3/4 in. centers. The Range and Differential adjustments are accessed by removing the front cover.

- Maximum allowable positive pressure: 100 psig.
- Diaphragms are oil resisting, nitrile butadiene rubber (Buna-N).
- For electrical ratings and temperature limitations, see table on page 8/83.
- For dimensions and modifications, see page 99.

9016GAW Vacuum Switch for Control Applications, Diaphragm Actuated

Range on Decreasing Vacuum (inHg)	Adjustable Differential (inHg) Adds to Range (1)		Contact Arrangement	Pipe Tap (NPTF)	Class 9016 Type NEMA Enclosure Type	
	@ Minimum Range	@ Mid-Range			4, 4X & 13	7 & 9
0–28.7	0.8–9	1.3–7.4	1 N.O.–1 N.C.	1/4"–18	GAW1	GAR1
0–25	5–20	5–20	1 N.O.–1 N.C.	1/4"–18	GAW2	N/A
0–28.3	1–9	1.7–7.4	2 N.O.–2 N.C.	1/4"–18	GAW21	GAR21
0–25	5–20	5–20	2 N.O.–2 N.C.	1/4"–18	GAW22	N/A

Specifications

Fluids Controlled	Air, water, hydraulic oils, gases, steam (depending on the model)	
Pressure Connection	NEMA 4, 4X & 13: 1/4"–18 NPTF (standard), G1/4 (BSP) female, or 1/2"–14 NPT. NEMA 7 & 9: 1/4" NPTF	
Weight (approximate)	Type 4, 4X, and 13: 3 lb (1.36 kg); Type 7 & 9: 10 lb (4.54 kg)	
Voltage Limits	600 V	
Continuous Current	10 A	
Electrical Connections	NEMA 4, 4X & 13: 1/2"–14 NPTF NEMA 7 & 9: 3/4"–14 NPTF	
Standards/Ratings	CE, IEC 60957.5.1, UL 508, CSA 3211-03	
Temperature Ratings	Minimum	Maximum
Ambient	–23 °C (–10 °F)	+85 °C (+185 °F)
Media	Diaphragm: –40 °C (–40 °F) Piston: –26 °C (–15 °F) All with Form Q4: –26 °C (–15 °F)	+120 °C (+250 °F)

Operating Curves

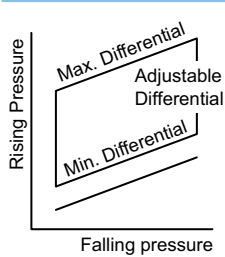

Contact Blocks

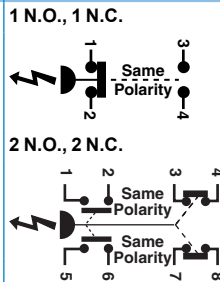

Connection

Form H17

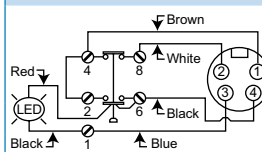

Form H10

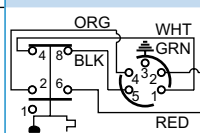

Form H11

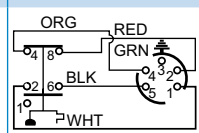

SPDT snap switches contain two double-break contact elements (1 N.O., 1 N.C.) that must be used on circuits of the same polarity. **DPDT** snap switches contain two electrically separated sets of contact elements allowing use on circuits of opposite polarity. Each set contains two double-break contact elements (1 N.O., 1 N.C.) that must be used on circuits of the same polarity.

Acceptable Wire Sizes:

12–22 AWG

Recommended Terminal Clamp Torque:

7 lb-in

(1) Add the Differential to the Range to obtain the operating point on increasing vacuum (within vacuum limitations). The differential increases linearly over the range. The minimum differential doubles with NEMA 7 & 9 enclosures.



File E12443 Haz Loc
File E12158
File E12158
CCN NOWT (GAR)
CCN NKPZ (GAW)
CCN NTHT
Marine Use (GAW)



File LR 25490
Class 3211 06
Type GAW only
File LR26817
Type GAR only
(NEMA 7 and 9 Haz. Loc.)



9012G and 9016G

Industrial pressure and vacuum switches
9016G vacuum switches
Power applications



9016GVG1J10

9016GVG Power Switches

The 9016GVG1 is designed as a companion to the 9036GG float switches in common use on vacuum heating pumps. Electrical ratings of float and vacuum switch types are equal.

For dimensions and modifications, see page 98.

9016GVG Vacuum Switch for Power Applications

NEMA 1 Enclosure

Contacts Open on Increasing Vacuum

Cut-Out Range, inHg	Approximate Adjustable Differential, inHg	Cut-In Range, inHg	Poles	Pressure Connection	Vacuum Setting, inHg	NEMA 1 Enclosure Class 9016 Type
5–25	5–10 inHg	0–20	2	1/4"-18 NPSF	3–8	GVG1J09
					16.5–25	GVG1J10
					17–22	GVG1J11
					18–23	GVG1J12
					20–25	GVG1J13
					Specify other vacuum (minimum order quantity: 4 pieces)	GVG1J99

Specifications

Fluids Controlled	Air, water, hydraulic oils, gases, steam (depending on the model)	
Pressure Connection	1/4"-18 NPTF (standard), G1/4 (BSP) female, or 1/2"-14 NPT. See Forms table, page 99.	
Max. Allowable Positive Pressure	100 psig	
Weight (approximate)	2 lb (0.91)	
Voltage Limits	600 V	
Continuous Current	10 A	
Electrical Connections	3 knockouts for 1/2" conduit	
Standards/Ratings	CE, IEC 60957.5.1, UL 508, CSA 3211-03	
Temperature Ratings	Minimum	Maximum
Ambient	-23 °C (-10 °F)	+85 °C (+185 °F)
	Diaphragm	+120 °C (+250 °F)
Media	Piston	
	All with Form Q4	
	-26 °C (-15 °F)	

Operating Curves

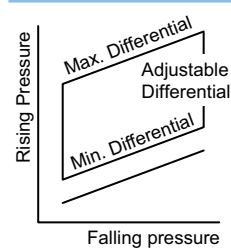

Contact Blocks

DPST

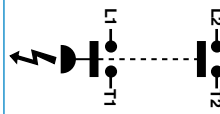

Acceptable Wire Sizes:

8–14 AWG

Recommended Terminal Clamp Torque:

22-27 lb-in

For other ratings and specifications, see page 8/82.

Available Modifications for 9016GVG Vacuum Switches

Description	Form
3-way lever plus nameplate with marking: <i>Float only—Vacuum and Float—Continuous</i> (factory modification only)	E
Mounting bracket (for retrofit, order 9049A53 bracket kit)	F
Reverse action, normally open contacts	R
1/4 in. male pipe connection (1/4"-18 NPT, external thread) (for retrofit, use 1/4" pipe nipple)	Z



File E12158
CCN NKPZ



File LR 25490



Machine Tool Pressure Switch Dimensions

9012 GAW, GDW, GWK 1, 21

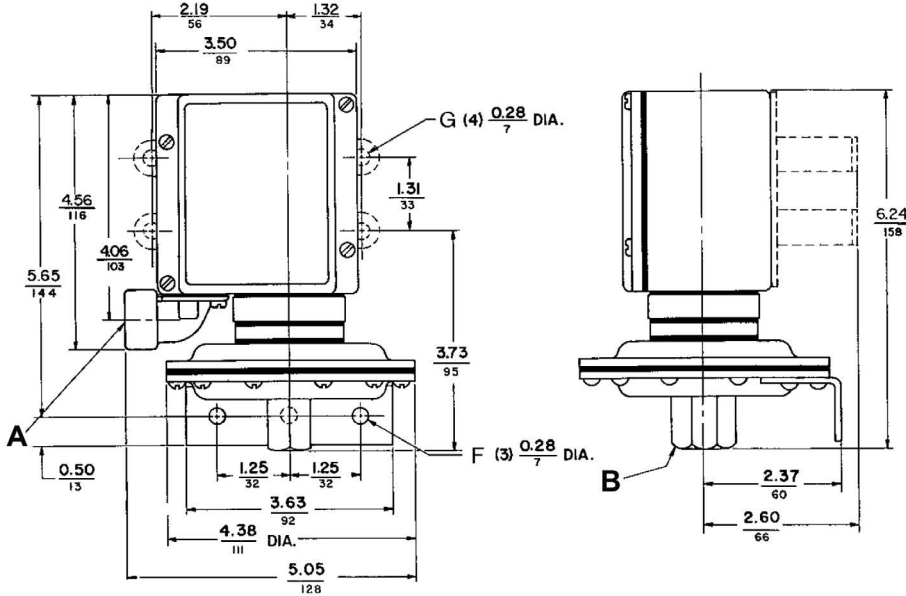

A: Conduit connection: G•W = 1/2-14 NPT; G•WM = 20mm BS4568, Form M12 = Pg13.5; DIN40430.
B: Pressure connection: G•W = 1/4"-18 NPTF; G•WM = 8; Form M14 = G 1/4 BS 2779; RP1/4 ISO 711; R 1/4 DIN 2999; GJ 1/4 UN1339.

9012 GAW, GBW, GCW, GDW, GEW, GFW, GWK, GLW, and GMW (except GAW, GDW, GWK 1, 21)

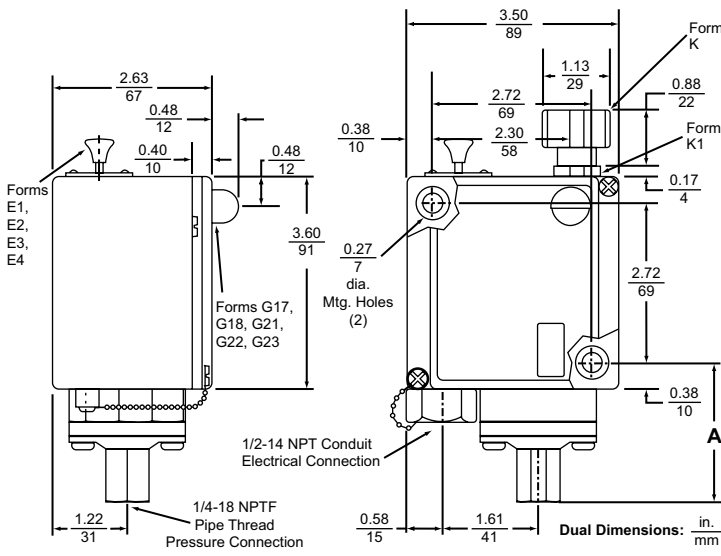

Type	Dimension A, in. (mm)
GAW, GDW, GWK 2, 4, 5, 6, 22, 24, 25, 26	2.33 (59)
GBW, GEW, GLW 1, 2, 21	2.23 (57)
GCW, GFW, GMW 1, 2, 3, 4, 21, 22, 23, 24	3.15 (80)

NOTE: Dimensions change with metric thread.
 For flange and mounting bracket dimensions for low pressure device, see figure on page 99.

9012 GGW, GHW, GJW (Differential-Pressure)

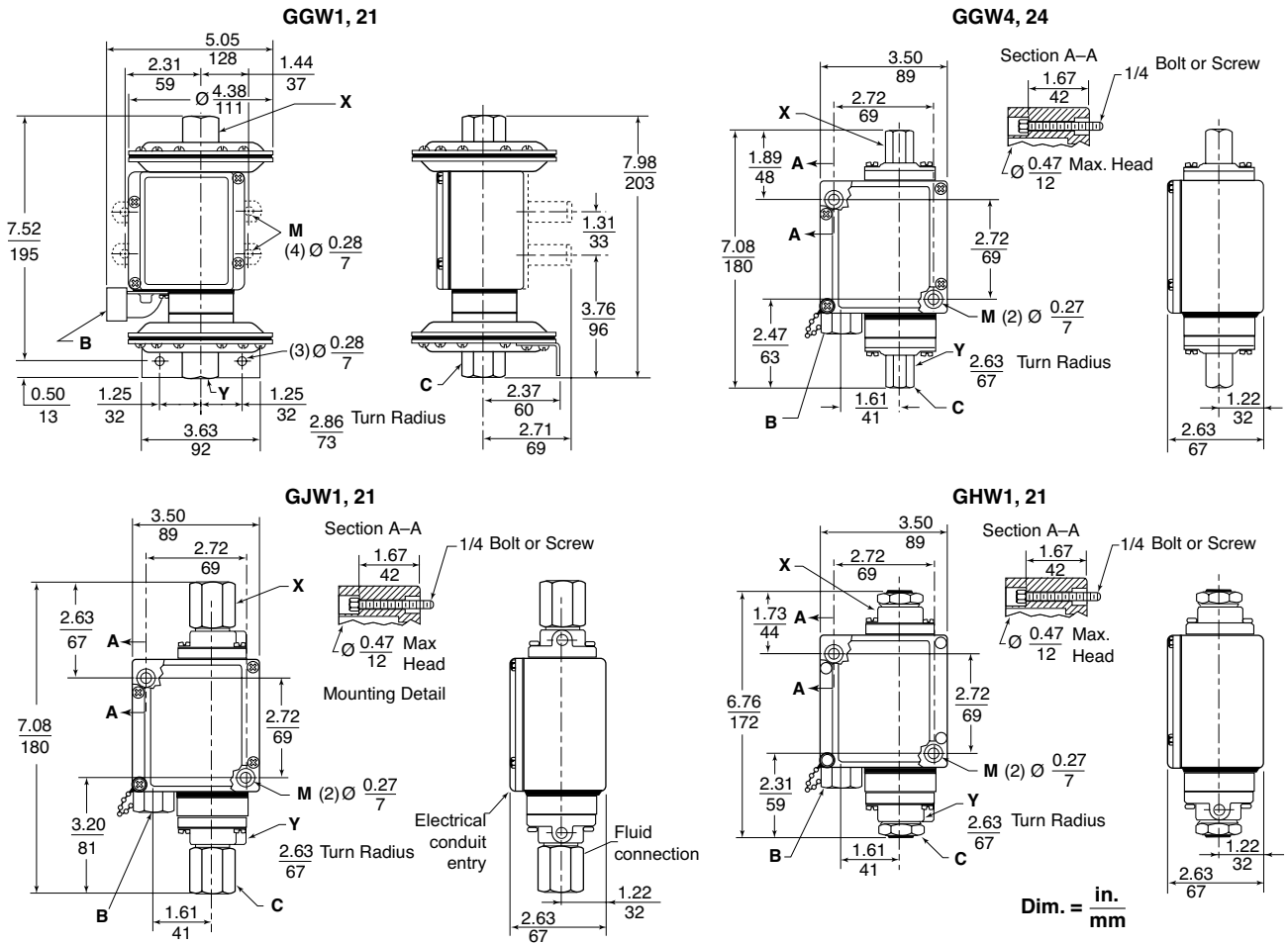

Types GAR, GBR, GCR, GDR, GER, and GFR

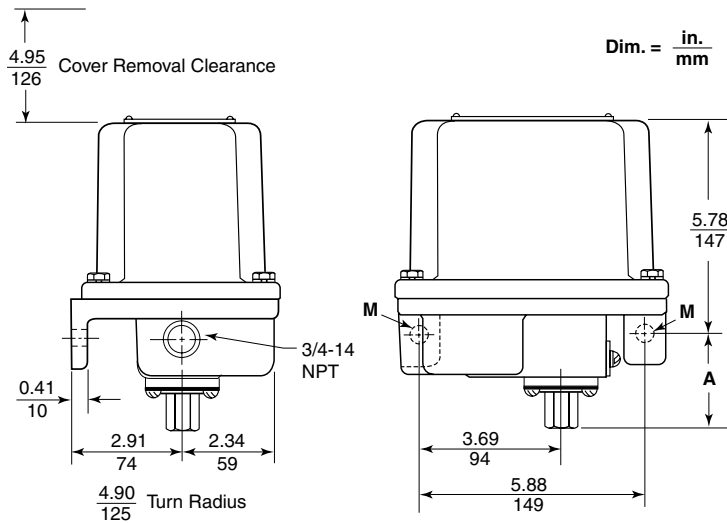

Dimension A for G•R Switches

Type	Dimension A, in. (mm)
GAR1, 2, 21, 22	2.02 (56)
GAR4, 5, 6, 24, 25, 26	1.42 (36)
GBR1, 2, 21, 22; GCR1, 21	1.32 (34)
GCR2, 3, 4, 22, 23, 24	2.24 (57)
GDR1, 2, 21, 22	2.02 (56)
GDR4, 5, 6, 24, 25, 26	1.42 (36)
GER1, 2, 21, 22; GFR1, 21	1.32 (34)
GFR2, 3, 4, 22, 23, 24	2.24 (57)

9012G and 9016G

Industrial pressure and vacuum switches
9012G pressure switches

Types GNO1, GRO1

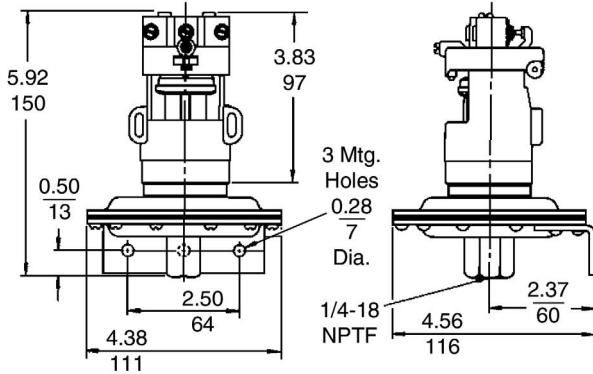

Types GNG1, GRG1

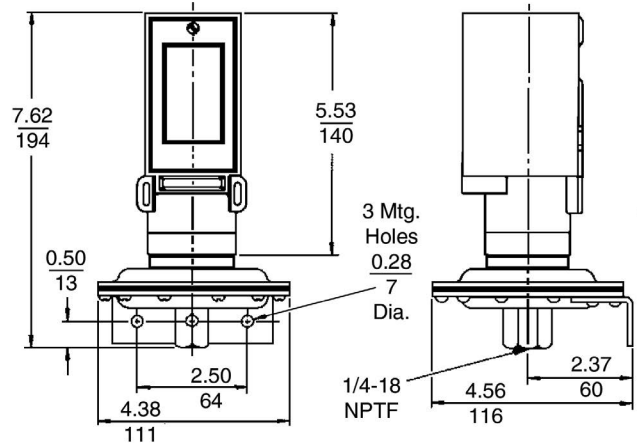

Types GNO, GRO

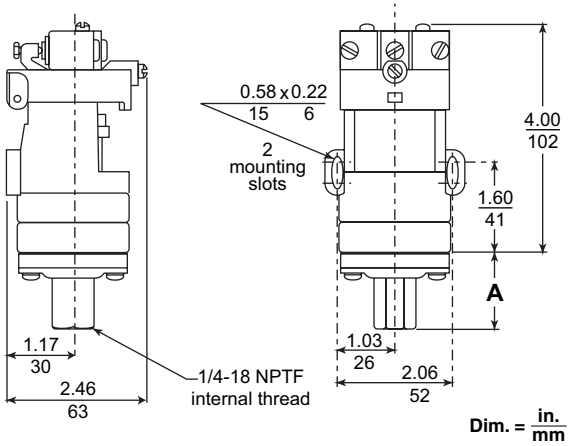

Types GNG, GPG, GQG, GRG, GSG, and GTG

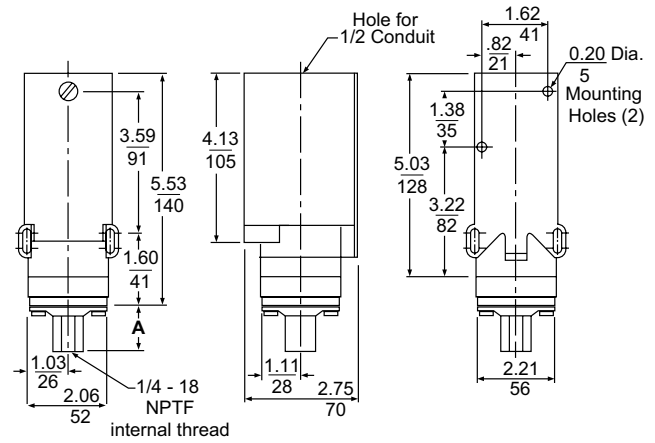

Dimension A for G•O Switches

Type	Dimension A, in. (mm)
GNO, GRO 3, 4, 5, 6	1.41 (36)
GPO, GSO 1, 2, 3	1.31 (33)
GQO, GTO 1, 2, 3, 4	2.24 (57)

Dimension A for G•G Switches

Type	Dimension A, in. (mm)
GNG, GRG 3, 4, 5, 6	1.41 (36)
GPG, GSG 1, 2, 3	1.31 (33)
GQG, GTG 1, 2, 3, 4	2.24 (57)

Vacuum Switch Dimensions and Modifications

9016GAW Control Vacuum Switches—Dimensions

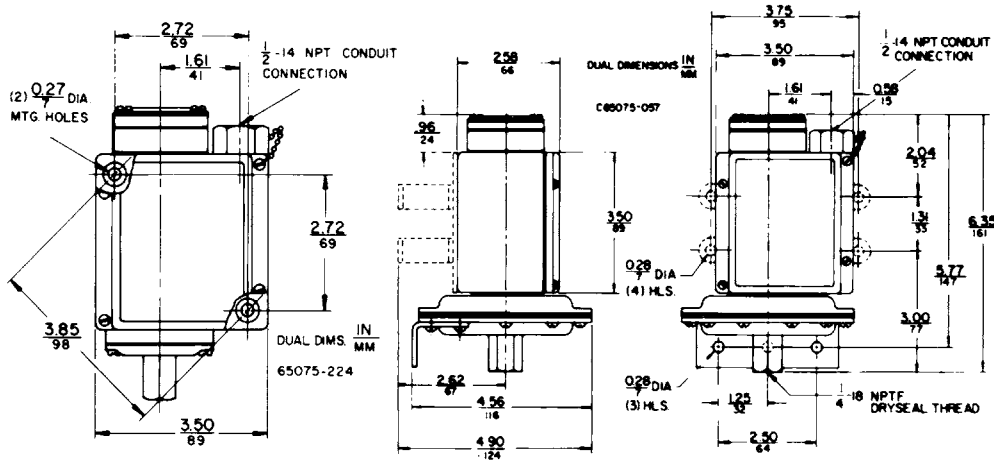

9016GAW Vacuum Switches—Available Modifications

Description	Form
Mounting feet (GAW 1, 21 only)	F
Viton® diaphragm with #316 stainless steel flange	Q4
Range scale window (standard with Forms K and K1)	V1
Special setting specified (If indicating only one special setting, specify whether this setting is on increasing or decreasing pressure.)	Y1
1/4"-18 NPT external thread pressure connection	Z
1/2"-14 NPT external thread, 1/4"-18 NPTF internal thread pressure connection (standard actuator only)	Z16

9016GVG Power Vacuum Switches—Dimensions

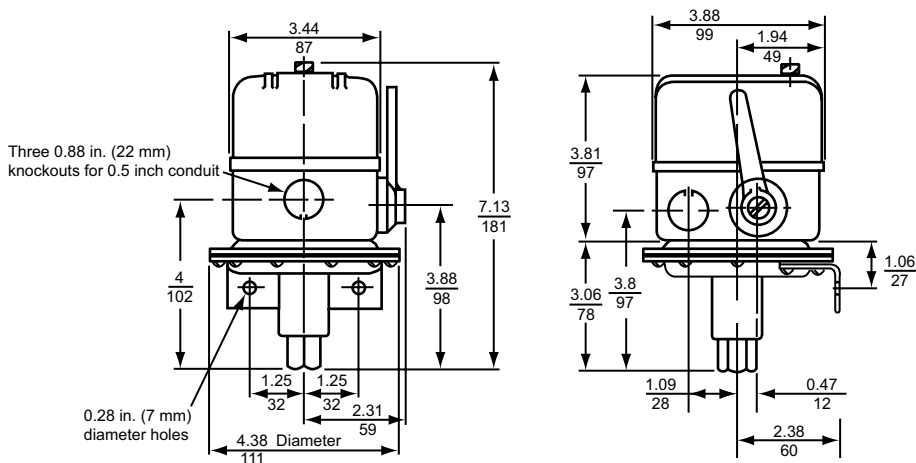

9016GVG Vacuum Switches—Available Modifications

Description	Form
3-way lever plus nameplate with marking: <i>Float only—Vacuum and Float—Continuous</i> (factory modification only)	E
Mounting bracket (for retrofit, order 9049A53 bracket kit)	F
Reverse action, normally open contacts	R
1/4 in. male pipe connection (1/4"-18 NPT, external thread) (for retrofit, use 1/4" pipe nipple)	Z

NOTE: For renewal parts, see page 98.

Telemecanique™ Sensors

www.tesensors.com

Schneider Electric USA, Inc.
1875 Founders Drive
Dayton, Ohio 45420
(800) 435-2121
www.tesensors.us

Schneider Electric Canada, Inc.
5985 McLaughlin Road
Mississauga, Ontario L5R 1B8
(800) 435-2121
www.tesensors.ca

Electrical equipment should be installed, operated, serviced, and maintained only by qualified personnel. No responsibility is assumed by Schneider Electric for any consequences arising out of the use of this material.

The information provided in this documentation contains general descriptions and/or technical characteristics of the performance of the products contained herein. This documentation is not intended as a substitute for and is not to be used for determining suitability or reliability of these products for specific user applications. It is the duty of any such user or integrator to perform the appropriate and complete risk analysis, evaluation and testing of the products with respect to the relevant specific application or use thereof. Neither Schneider Electric nor any of its affiliates or subsidiaries shall be responsible or liable for misuse of the information contained herein.

Schneider Electric, Square D, Telemecanique, OsiSense, and Simply easy! are trademarks owned by Schneider Electric Industries SAS or its affiliated companies. All other trademarks are the property of their respective owners.

9012CT9701R06/13 August 2013 © 1998–2013 Schneider Electric. All Rights Reserved.
Replaces 9012CT9701R04/09 dated 10/2009