

## Low Water Cut-Off/Pump Controllers For Steam Boilers

### Series 150, 150S Series 157, 157S

The Series 150S is available as an alternative for Series 150 LWCO controls that contain mercury switches. Please keep in mind that in a replacement or repair situation you do not have to change out the entire control. A head replacement (i.e. 150S-HD) is all that's required.

There may be additional letters such as 'B', 'R', 'RL', etc. in the sales catalog designation of the control. These additional letters designate tapping locations and sizes which have no affect on which head mechanism to purchase. All head mechanisms are interchangeable and can be installed on any body.

#### 'MD' Models

The 'MD' model should be used as a replacement head when the boiler operating pressure is less than 50 psi. These were created to provide a control with factory settings to compensate for the narrowing of setpoints. The larger differential between pump on and burner off reduces the potential for nuisance burner shutdown.

**It is important to understand that there are requirements that lead to the best performance of ALL level controllers and LWCO's:**

- Use of properly-sized pump starters/relays in the pump control circuitry
- Pumps that are balanced to the system requirements
- Equalizing piping, per the boiler manufacturer's recommendations, to properly sense the boiler water level
- Industry accepted blowdown piping to provide best cleaning action of the control chamber, float linkage mechanism and/or probes
- Proper periodic blowdown of the boiler controls.
- Proper chemical treatment of boiler water.
- Annually cleaning and careful examination of the float mechanism, probes, and electrical switches or controls. More frequent cleaning may be required for exceptionally dirty steam systems.



150 or 150S  
Float Chamber Body



157 or 157S  
Water Column Body

## Low Water Cut-Off/Pump Controllers For Steam Boilers

### Series 150, 150S Series 157, 157S

(continued)

#### Replacement Head Mechanisms

For Model	Part Number	Repl. Head Model No.	Description	Weight lbs. (kg)
150S-HD	173003		Head mechanism	11.0 (5.0)
150S-M-HD	173203	150S-HD	w/manual reset	11.0 (5.0)
150S-MD-HD	173103	150S-HD	w/maximum differential	11.0 (5.0)
150S-M-MD-HD	173302	150S-HD	w/manual reset and maximum differential	11.0 (5.0)
158S-HD	178602		Head mechanism	12.5 (5.7)
158S-M-HD	178702	158-S-HD	w/manual reset	12.5 (5.7)
159S-HD	178702		Head mechanism	12.0 (5.7)

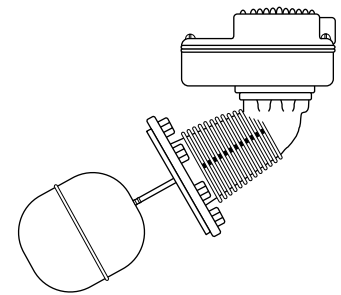

**Series 150S-HD**

## Low Water Cut-Off/Pump Controllers For Steam Boilers

### Series 150, 150S Series 157, 157S

**IMPORTANT:**

- Snap switches **must** be replaced as an assembly.
- We recommend complete head replacement to eliminate the need for field adjustment of the switch assembly.
- Series 150S and 157S replacement switch assemblies are not interchangeable with Series 150 and 157 mercury switch controls.

**Note:**

Manual reset models with date code 03K (October 2003) or older require the purchase of a new head.

### Replacement Switch Assemblies for Series 150S and 157S

For Model	Repl. Switch Model No.	Part Number	Description	Weight lbs. (kg)
All 150S & 157S Units Except 'MD' Models	SWA-150S	310462	Snap-action switch assembly	0.5 (.23)
All 150S & 157S 'MD' Models	SWA-150S-MD	310464	Snap-action switch assembly for maximum differential models	0.5 (.23)
All 158S Models	SWA-158S	310468	Snap-action switch assembly for Model 158S	0.5 (.23)
All 159S Models	SWA-159S	310470	Snap-action switch assembly	0.5 (.23)

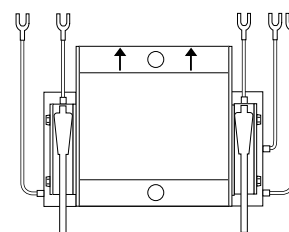

**Model SWA-150S  
Model SWA-150S-MD**

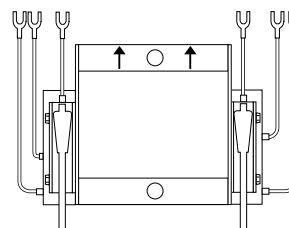

**Model SWA-158S**

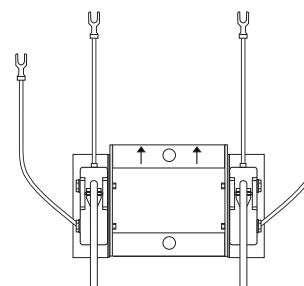

**Model SWA-159S**

Switch assemblies include a mounting bracket and color-coded terminal connection wires.

## Low Water Cut-Off/Pump Controllers For Steam Boilers

**Series 150, 150S**  
**Series 157, 157S** (continued)

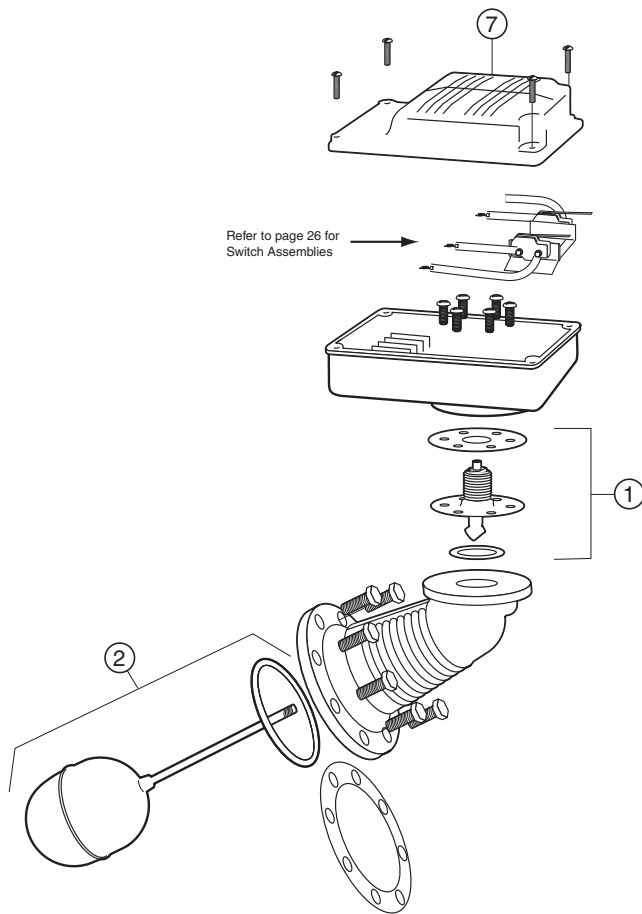

**Series 150S**

### Series 150 Head Gasket and Casting

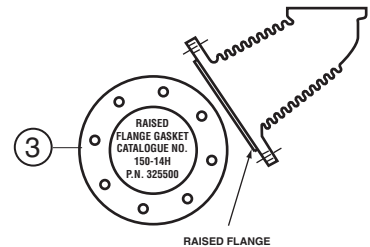

This new gasket, specifically designed for the Raised Flange Heads, may be used.

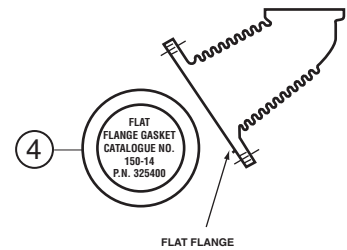

This gasket **must** be used on the Flat Flange Heads.

### Components

Item Number	Model Number	Part Number	Description	Weight lbs. (kg)
1	SA150-106R	347900	Bellows assembly	0.4 (.18)
2	SA150-11	347600	Float & rod	1.0 (0.5)
3	150-14H	325500	Head gasket for raised face flange head, 8 holes	0.5 (.23)
4	150-14	325400	Head gasket for flat face flange head, no holes	0.5 (.23)
7	150-436	326950	Cover	.435 (.19)

## Low Water Cut-Off/Pump Controllers For Steam Boilers

**Series 150, 150S**

**Series 157, 157S** (continued)

### Components

Item Number	Model Number	Part Number	Description	Weight lbs. (kg)
1	EA-157-S	354106	Short electrode for 157S-RBP	0.5 (.23)
2	EA-157-L	354107	Long electrode for 157S-RBP	0.5 (.23)

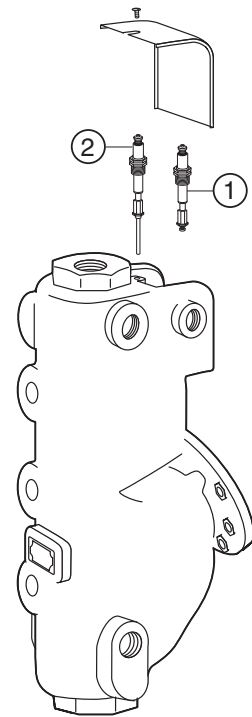

**Model 157S-RBP**