

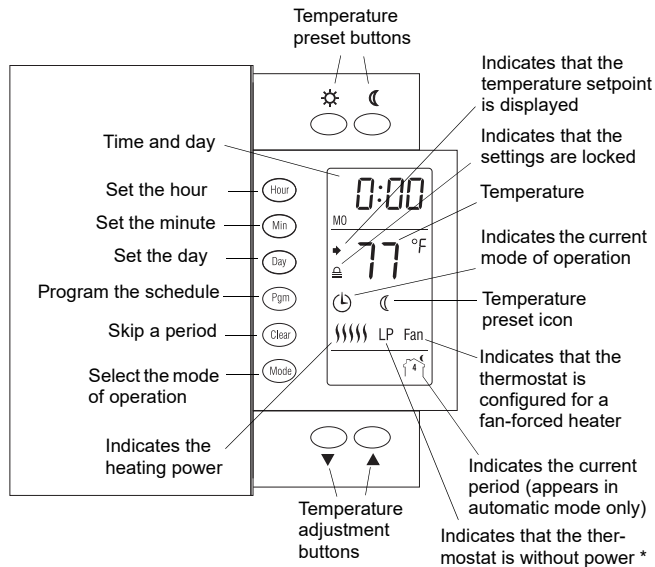

TH106, TL6160 Programmable Thermostat

OWNER'S GUIDE



* LP appears only for the first two minutes when the thermostat is without power. This can occur during a power outage or when the thermal protection device inside the baseboard heater is opened.

1. Description

This programmable thermostat can be used to control an electric heating system such as an electric baseboard heater, a radiant ceiling, a radiant floor, a convector or a fan-forced heater.

The thermostat cannot be used with:

- a resistive load over 16.7 A
- a resistive load under 2 A
- a system driven by a contactor or relay (inductive load)
- a central heating system

SUPPLIED PARTS:

- One (1) thermostat
- Two (2) 6-32 screws
- Two (2) solderless connectors

2. Installation

TURN OFF POWER TO THE HEATING SYSTEM AT THE MAIN POWER PANEL TO AVOID ELECTRICAL SHOCK. THE INSTALLATION MUST BE PERFORMED BY AN ELECTRICIAN.

- All cables and connections must conform to the local electrical code.
- Special CO/ALR solderless connectors must be used when connecting with aluminum conductors.
- Install the thermostat onto an electrical box.
- Install the thermostat about 5 feet high, or an inside wall facing the heater.
- Avoid locations where there are air drafts (such as the top of a staircase or an air outlet), dead air spots (such as behind a door), or direct sunlight.
- Do not install the thermostat on a wall that conceals chimney or stove pipes.
- The thermostat wires are not polarized; either wire can be connected to the load or to the power supply.

NOTE: Always keep the thermostat's vents clean and unobstructed.



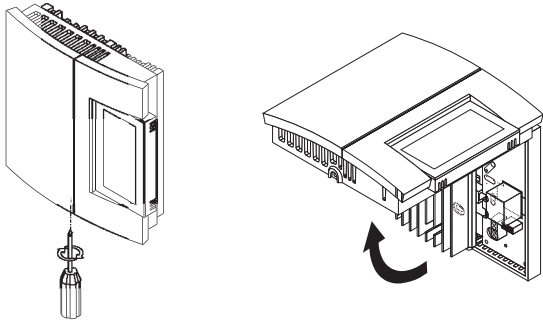

1. Connect the thermostat wires to the line wires and to the load wires using solderless connectors for copper wires.

2-wire installation

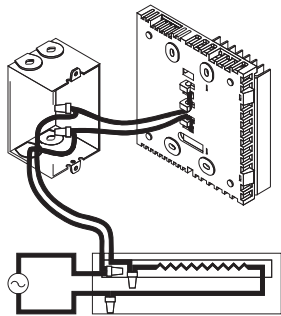

4-wire installation

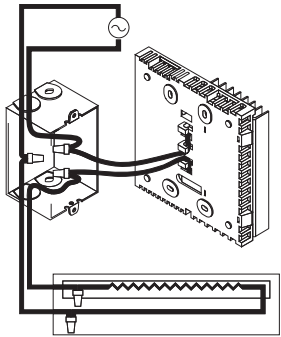

2. Push any excess wire back into the electrical box.

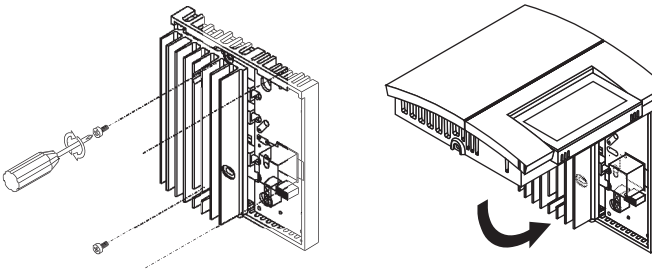

NOTE: If necessary, before re-installing the front component, configure the thermostat (see section 3).

3. Return power to heating system.

3. Configuration

The configuration switches are on the back of the thermostat. The factory settings are indicated by the gray cells in the following table.

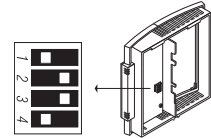

		<input type="checkbox"/>	<input type="checkbox"/>
SW1	Early Start ^a	Off	On
SW2	Display format	°C / 24-hour	°F / 12-hour
SW3	Cycle length ^b	15 seconds Baseboard heater	5 minutes Fan-forced heater
SW4	Keypad lock ^c	Off	On

- Early Start can be used in Automatic mode only. When this function is enabled, the thermostat calculates the optimal time to start heating in order to obtain the desired temperature by the set time. The thermostat re-assesses the start time daily based on the previous day's performance.
- You must select 5 minutes if you have a fan-forced heater. The word FAN is displayed when this setting is selected. Select 15 seconds for better temperature control in most other cases.
- The settings are locked. The temperature adjustment buttons only allow you to view the temperature setpoint.

4. Clock and Day Setting

1. Press the **Hour** button to set the hour.
2. Press the **Min** button to set the minutes.
3. Press the **Day** button to set the day.
4. Press the **Mode** button to end.

Daylight Savings Time

The thermostat can automatically re-adjust its clock at Daylight Savings Time changeover. When this function is enabled (On), the thermostat switches to Daylight Savings Time on the second Sunday of March and to normal time on the first Sunday of November.

NOTE: The function is disabled (default setting) when the clock loses its setting.

1. Press the **Day** button (3 seconds) until **DLS** appears on the screen.
2. Press either of the **▲▼** buttons to toggle between On (enabled) and Off (disabled).
3. Press the **Day** button briefly. The year setting is displayed.
4. Press either of the **▲▼** buttons to set the current year.
5. Press the **Day** button briefly. The month setting is displayed.
6. Press either of the **▲▼** buttons to set the current month.
7. Press the **Day** button briefly. The date setting is displayed.
8. Press either of the **▲▼** buttons to set the current date.
9. Press the **Mode** button to end.

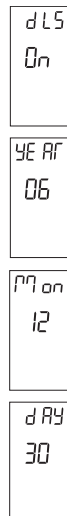

5. Temperature Settings

Setpoint

The thermostat normally displays the actual temperature. To view the setpoint, press the ▲ or ▼ button briefly. The setpoint will appear for the next 5 seconds.

To change the setpoint, press the ▲ or ▼ button until the desired temperature is displayed. To scroll faster, hold the button.

Using a preset temperature

The thermostat has 3 preset temperatures:

- Comfort temperature ☀
- Economy temperature ☾
- Vacation temperature ☑

Icon	Intended Use	Factory Setting
☀	Comfort (when at home)	70°F (21°C)
☾	Economy (when asleep or away from home)	62°F (16.5°C)
☑	Vacation (during prolonged absence)	50°F (10°C)

- To use the Comfort or Economy temperature, press the ☀ or ☾ button respectively. The corresponding icon will be displayed.
- To use the Vacation temperature, press both ☀ and ☾ buttons simultaneously. The ☑ icon will be displayed.

Storing a preset temperature

To store the Comfort or Economy temperature:

Set the desired temperature using the ▲ or ▼ button.

Press and hold the appropriate button (☀ or ☾) for approximately 3 seconds until the corresponding icon is displayed.

To store the Vacation temperature:

Set the desired temperature using the ▲ or ▼ button.

Press and hold both ☀ and ☾ buttons simultaneously for approximately 3 seconds until the ☑ icon is displayed.

6. Modes of Operation

Ⓞ **Automatic** - The temperature is set according to the programmed schedule. To place the thermostat in this mode, press the **Mode** button until Ⓞ is displayed. The icons of the current period and preset temperature are also displayed.

Temporary Bypass: If you modify the setpoint (by pressing the ▲, ▼, ☀, or ☾ button) when the thermostat is in automatic mode, the new setpoint will be used until the end of the current period. When the next period starts, the temperature set for that period becomes the new setpoint. To cancel the bypass, press the **Mode** button.

⚡ **Manual** - The programmed schedule is not used. The temperature must be set manually. To place the thermostat in this mode:

1. Press the **Mode** button until ⚡ is displayed.
2. Set the temperature using the ▲, ▼, ☀ or ☾ button.

7. Schedule

The schedule consists of 4 periods per day which represents a typical weekday. You can program the thermostat to skip the periods that do not apply to your situation. For example, you can skip periods 2 and 3 for the weekend.

Period	Description	Setting
☀	Wake	☀
☾	Leave	☾
☀	Return	☀
☾	Sleep	☾

The Comfort (☀) temperature is used in periods 1 and 3 and the Economy (☾) temperature is used in periods 2 and 4. For example, when the period changes from 1 to 2, the setpoint automatically changes from Comfort setting (☀) to Economy setting (☾).

You can have a different program for each day of the week; i.e., each period can start at different time for each day of the week. The thermostat has been programmed with the following schedule.

Period	Setting	MO	TU	WE	TH	FR	SA	SU
☀	☀	6:00 AM	6:00 AM	6:00 AM	6:00 AM	6:00 AM	6:00 AM	6:00 AM
☾	☾	8:00 AM	8:00 AM	8:00 AM	8:00 AM	8:00 AM	--:--	--:--
☀	☀	6:00 PM	6:00 PM	6:00 PM	6:00 PM	6:00 PM	--:--	--:--
☾	☾	10:00 PM	10:00 PM	10:00 PM	10:00 PM	10:00 PM	10:00 PM	10:00 PM

To modify the schedule:

1. Press **Pgm** to access the programming mode. Period 1 is selected.
2. Press **Day** to select the day to program (hold for 3 seconds to select the entire week.)
3. Press **Hour** and **Min** to set the start time of the selected period, or press **Clear** if you want to skip the period (--:-- is displayed).
4. Press **Pgm** to select another period, or press **Day** to select another day. Then repeat step 3.
5. Press **Mode** to exit the programming mode.

NOTE: If no button is pressed for 60 seconds, the thermostat will automatically exit the programming mode.

8. Power Outage

During a power outage, **LP** (Low Power) appears for the first minute. Then the screen becomes blank. The settings are stored in memory. *After initial installation, product must be connected to power for a minimum of two hours to enable the power outage feature.* However, if the power failure exceeds 4 hours, the thermostat's clock must be re-adjusted and, if you are using the automatic Daylight Savings Time changeover function, it must be re-enabled. When power returns, the thermostat will return to the mode of operation active prior to the power failure.

9. Troubleshooting

Problem	Solutions
Thermostat is hot.	Under normal operation, the thermostat housing can reach a temperature between 95°F (35°C) and 104°F (40°C).
LO is displayed.	The measured temperature is below the display range. Heating is activated.
HI is displayed.	The measured temperature is above the display range.
Wrong temperature is displayed.	The thermostat is exposed to air draft. Eliminate the draft. The sticker on the thermostat's screen has not been removed.
Wrong time is displayed.	The thermostat was without power for more than 4 hours.
Temperature does not change according to the programmed schedule.	Check that the thermostat is in Automatic mode. Check the schedule and clock settings.
LP appears on the screen or the screen is blank despite there is no power outage.	The thermal circuit breaker in the heater is opened. This can happen if the heater is obstructed by furniture or curtain and has overheated, or if the thermal circuit breaker is defective.
Display looks faded when heating is activated	The heating system is less than the required minimum load. This thermostat cannot be used below that rating.
The settings cannot be changed.	The settings are locked (see section 3).
E2 is displayed	The thermostat performance is reduced due to a sensor error. Please contact technical support for more information.

10. Technical Specifications

Power:
120/240 VAC, 60 Hz

Minimum load:
2 A (resistive only)
250 W @ 120 VAC
500 W @ 240 VAC

Maximum load:
16.7 A (resistive only)
2000 W @ 120 VAC
4000 W @ 240 VAC

Display range:
32°F to 140°F (0°C to 60°C)

Display resolution:
1°F (0.5°C)

Setpoint range:
40°F to 86°F (5°C to 30°C)

Setpoint interval:
1°F (0.5°C)

Storage:
-4°F to 120°F (-20°C to 50°C)

Approval:
c UL us

ICES-003 Class B Notice
This Class B digital apparatus complies with Canadian ICES-003.



1-year limited warranty

Resideo warrants this product to be free from defects in workmanship or materials, under normal use and service, for a period of one (1) year from the date of first purchase by the original purchaser. If at any time during the warranty period the product is determined to be defective due to workmanship or materials, Resideo shall repair or replace it (at Resideo's option).

If the product is defective,

- (i) return it, with a bill of sale or other dated proof of purchase, to the place from which you purchased it; or
- (ii) call Resideo Customer Care at 1-800-468-1502. Customer Care will make the determination whether the product should be returned to the following address: Resideo Return Goods, 1985 Douglas Dr. N., Golden Valley, MN 55422, or whether a replacement product can be sent to you.

This warranty does not cover removal or reinstallation costs. This warranty shall not apply if it is shown by Resideo that the defect was caused by damage which occurred while the product was in the possession of a consumer.

Resideo's sole responsibility shall be to repair or replace the product within the terms stated above. RESIDEO SHALL NOT BE LIABLE FOR ANY LOSS OR DAMAGE OF ANY KIND, INCLUDING ANY INCIDENTAL OR CONSEQUENTIAL DAMAGES RESULTING, DIRECTLY OR INDIRECTLY, FROM ANY BREACH OF ANY WARRANTY, EXPRESS OR IMPLIED, OR ANY OTHER FAILURE OF THIS PRODUCT.

Some states do not allow the exclusion or limitation of incidental or consequential damages, so this limitation may not apply to you.

THIS WARRANTY IS THE ONLY EXPRESS WARRANTY RESIDEO MAKES ON THIS PRODUCT. THE DURATION OF ANY IMPLIED WARRANTIES, INCLUDING THE WARRANTIES OF MERCHANTABILITY AND FITNESS FOR A PARTICULAR PURPOSE, IS HEREBY LIMITED TO THE ONE YEAR DURATION OF THIS WARRANTY. Some states do not allow limitations on how long an implied warranty lasts, so the above limitation may not apply to you.

This warranty gives you specific legal rights, and you may have other rights which vary from state to state. If you have any questions concerning this warranty, please write Resideo Customer Care, 1985 Douglas Dr, Golden Valley, MN 55422 or call 1-800-468-1502.



Resideo Technologies, Inc.
1985 Douglas Drive North, Golden Valley, MN 55422

www.resideo.com

69-2202-07 M.S. Rev. 05-20 | Printed in United States