

T7351 Commercial Programmable Thermostat

FOR SINGLE- OR MULTI-STAGE CONVENTIONAL/HEAT PUMP SYSTEMS

PRODUCT DATA



FEATURES

- Typically used in buildings (including: restaurants, shopping malls, office buildings and banks) under 55,000 square feet.
- For single zone rooftop units, split systems, heat pumps or hot/chilled water systems.
- 365-day programming.
- Two Occupied and two Not Occupied periods per day.
- Individual heat and cool setpoints available for Occupied and Not Occupied periods.
- P+I+D control minimizes temperature fluctuations.
- Recovery ramp control automatically optimizes equipment start times based on building load.
- Convenient overrides allow temporary setpoint changes.
- Keypad multi-level lockout available with all models.
- Remote sensor capability for temperature (including outdoor air and discharge air) and humidity sensors.
- Auxiliary subbase contact typically interface with a Honeywell Economizer System (for total rooftop control integration) or act as dehumidification output.
- Universal Versaguard Thermostat guards available.

APPLICATION

The T7351 Commercial Programmable Thermostat controls 24 Vac commercial single zone heating, ventilating and air conditioning (HVAC) equipment. The T7351 consists of a thermostat and subbase. The thermostat includes the keypad and display for 365-day programming. The subbase includes equipment control connections. The subbase mounts on the wall and the thermostat mounts to the subbase.

Contents

Application	1
Features	1
Specifications	2
Ordering Information	2
Setting	6
Installer Setup	7
Operation	12
Troubleshooting Guide (Table 11)	17
Wiring Diagram (Figures 14 and 15)	19



63-2666-03

SPECIFICATIONS

IMPORTANT

The specifications given in this publication do not include normal manufacturing tolerances. Therefore, this unit might not exactly match listed specifications. This product is tested and calibrated under closely controlled conditions; minor performance differences can be expected if those conditions are changed.

Models: See Table 1.

Dimensions: Refer to Fig. 1.

Finish (color): Trident White.

Batteries: No batteries required

Table 1. T7351 Thermostat Features

Model	Application	Maximum Stages ^a		Features	Auxiliary Relay
		Heat	Cool		
T7351F	Conventional or Heat Pump	3 (2) ^b	3 (4) ^b	Humidity, Occupancy, Outdoor, Discharge Air Capability	Yes

^a This model is down-selectable and can be configured to control fewer stages than the maximum allowed.

^b Heat pump applications for this model have a maximum of two heat stages and two cool stages.

Mounting Means:

Mounts on subbase.

Subbase Mounts On:

Wall: Using two 5/8 in. long #6-32 screws (included).

Outlet Box: Using sheet metal screws.

Outdoor Sensor Wiring: Requires 18 gauge wire.

Humidity Ratings: 5% to 90% RH, noncondensing.

Emergency Heat Indication:

Display indicates when Emergency Heat is activated (Em).

Clock Accuracy at 77° F (25° C): ±1 min./month (30 days).

Temperature:

Ratings:

Operating Ambient: 30° to 110° F (-1° to 43° C).

Shipping: -30° to +150° F (-34° to +66° C).

Display Accuracy: ±1° F (±1° C).

Setpoint:

Range:

Heating: 40° to 90° F (4° to 32° C).

Cooling: 45° to 99° F (7° to 37° C).

Deadband: 2° F (1° C).

Default Settings: Refer to Table 2.

Minimum Stage Operation Time (fixed):

Minimum On

Heat: 1 minutes.

Cool: 3 minutes.

Minimum Off (Cool and Heat Pump): 1 minute.

Loss of Power: The thermostat maintains programmed times and temperatures for the life of the product. Clock and day information is retained for a minimum of 48 hours.

NOTE: To achieve the 48-hour power-loss clock retention, the T7351 must be powered for at least 5 minutes.

Electrical Ratings:

Power: 24 Vac, 50/60 Hz.; 20 to 30 Vac, 50/60 Hz.

Input:

Temperature: 20K ohms.

Humidity: 0-10 Vdc.

Outdoor: 3000 PTC.

Discharge Air: 20K ohms.

Occupancy Sensor: Dry contact switching 30 Vdc at 1 mA.

All Relay Outputs (at 30 Vac):

Running: 1.5A maximum.

Inrush: 7.5A maximum.

System Current Draw (without load):

5 VA maximum at 30 Vac, 50/60 Hz.

Approvals:

UL 873 Recognized, NEC Class 2.

FCC Part 15 subpart J Class A.

cUL.

NOTE: Relays are N.O. Single-Pole, Single-Throw (SPST).

ORDERING INFORMATION

When purchasing replacement and modernization products from your TRADELINE® wholesaler or distributor, refer to the TRADELINE® Catalog or price sheets for complete ordering number. If you have additional questions, need further information, or would like to comment on our products or services, please write or phone:

1. Your local Honeywell Environmental and Combustion Controls Sales Office (check white pages of your phone directory).
2. Honeywell Customer Care
1885 Douglas Drive North
Minneapolis, Minnesota 55422-4386
3. <http://customer.honeywell.com> or <http://customer.honeywell.ca>

International Sales and Service Offices in all principal cities of the world. Manufacturing in Belgium, Canada, China, Czech Republic, Germany, Hungary, Italy, Mexico, Netherlands, United Kingdom, and United States.

Table 2. Default Setpoints.

Control	Occupied	Not Occupied	Standby
Heating	70° F (21° C)	55° F (13° C)	67° F (19° C)
Cooling	75° F (24° C)	85° F (29° C)	78° F (26° C)

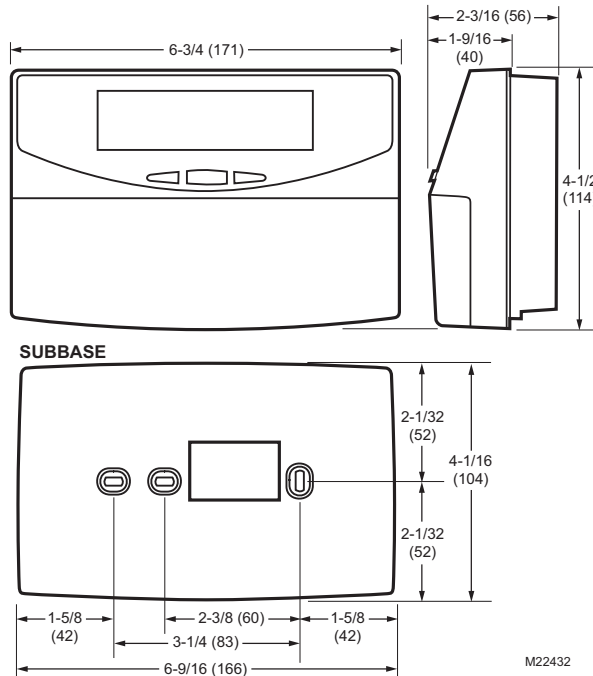

Fig. 1. Thermostat and Subbase Dimensions in inches (mm).

Accessories:**Duct Discharge Air Sensors:**

- C7041B (6 or 12 in. [152 or 305 mm]),
- C7041C (18 in. [457 mm]),
- C7041J (12 ft. [3.66 m] averaging),
- C7770A (8 in. [203 mm] probe).

Outdoor Air Sensors: C7170A,

- C7031G2014 (weatherproof).

Temperature Sensors (Remote): C7772A, TR21, TR22, TR23, and TR24 series, TR21-WK, TR23-WK, T7771.**Economizer Logic Modules:** W7210, W7212, W7215, W7459.**Humidity Sensors:** H7625, H7635.**Others:**

- 209541B FTT network termination module.
- 209651A Vertical Mounting Hardware Wallplate Adapter (Trident white).
- 50000452-001 Troubleshooting Cable.
- TG512 Universal Versaguard Thermostat guards.

INSTALLATION

When Installing this Product...

1. Read these instructions carefully. Failure to follow them could damage the product or cause a hazardous condition.
2. Check ratings given in instructions and on the product to ensure the product is suitable for your application.
3. Installer must be a trained, experienced service technician.
4. After installation is complete, check out product operation as provided in these instructions.



CAUTION

Electrical Shock or Equipment Damage Hazard.
Can shock individuals or short equipment circuitry.
Disconnect power supply before installation.

IMPORTANT

All wiring must agree with applicable codes, ordinances and regulations.



MERCURY NOTICE

If this control is replacing a control that contains mercury in a sealed tube, do not place your old control in the trash. Dispose of properly.

Contact your local waste management authority for instructions regarding recycling and the proper disposal of an old control. If you have questions, call Honeywell Customer Care Center at 1-800-468-1502.

Location

Do not install the thermostat where it can be affected by:

- drafts, or dead spots behind doors and in corners.
- hot or cold air from ducts.
- radiant heat from sun or appliances.
- concealed pipes and chimneys.
- unheated (uncooled) areas such as an outside wall behind the thermostat.

Subbase

WHEN USED TO SENSE ROOM TEMPERATURE

Install the thermostat about 5 ft. (1.5 m) above the floor in an area with good air circulation at average temperature. (Refer to Fig. 3.)

WHEN NOT USED TO SENSE ROOM TEMPERATURE

When using the remote-mounted temperature (and humidity) sensor(s) to sense ambient conditions, install the thermostat in an area that is accessible for setting and adjusting the temperature and settings.

CAUTION

Equipment Damage Hazard.

Can damage the TIM connection beyond repair. Disconnect the TIM cable prior to opening or closing the thermostat cover.

NOTE: Allow sufficient clearance below the thermostat to plug in the TIM cable.

Install the remote-mounted sensor(s) about 5 ft. (1.5 m) above the floor in an area with good air circulation at average temperature. (See Fig. 2.)

NOTE: Only TR21 models with neither setpoint adjustment nor bypass can be used for temperature averaging.

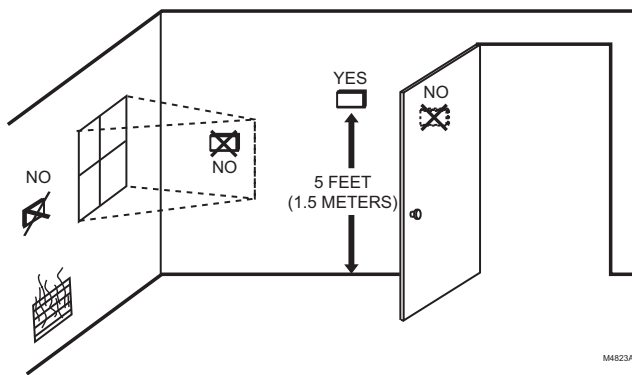

Fig. 2. Typical Location of Thermostat or Remote-Mounted Sensor.

IMPORTANT

To avoid electrical interference, which can cause erratic performances, keep wiring runs as short as possible and do not run thermostat wires adjacent to the line voltage electrical distribution systems. Use shielded cable (Belden type 8762 or equivalent for 2-wire). The cable shield must be grounded only at the controlled equipment case.

Mounting Subbase

The subbase mounts horizontally or vertically.

IMPORTANT

- When using the internal temperature sensor, the device must be mounted horizontally (with the LCD facing upwards). Precise leveling is not needed.
- When using remote sensors, thermostat mounting orientation does not matter.

Wall mounting (using standard drywall screws) is standard. Mounting to a 2 in. (50.8 mm) by 4 in. (101.6 mm) wiring box can be accomplished:

- for a horizontal box, no extra hardware is required.
- for a vertical box, part 209651A is required.
- Mount to European standard wall box 2.4 in. (having 61 mm between mounting screws in a horizontal line) with or without adaptive hardware.

1. Position and level the subbase.

NOTE: A level wallplate is only for appearance. The thermostat functions properly when not level.

2. Use a pencil to mark the mounting holes. (Refer to Fig. 6.)
3. Remove the subbase from the wall and drill two 3/16 in. (4.76 mm) holes in the wall (if drywall) as marked. For firmer material such as plaster or wood, drill two 7/32 in. (5.56 mm) holes.
4. Gently tap anchors (provided) into the drilled holes until flush with the wall.
5. Position the subbase over the holes, pulling wires through the wiring opening.
6. Loosely insert the mounting screws into the holes.
7. Tighten mounting screws.

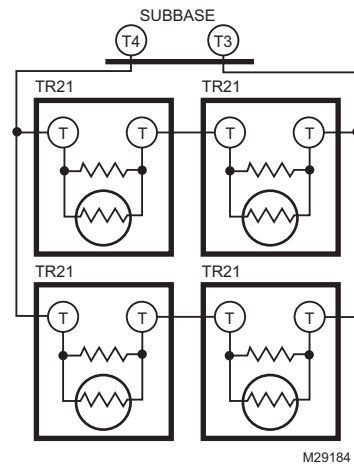
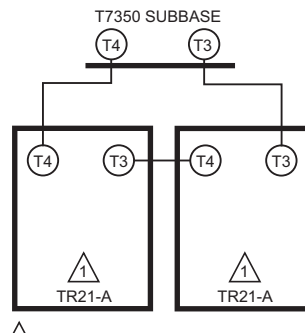

Fig. 3. Four TR21 Sensors providing a Temperature Averaging Network for T7351 Thermostat.



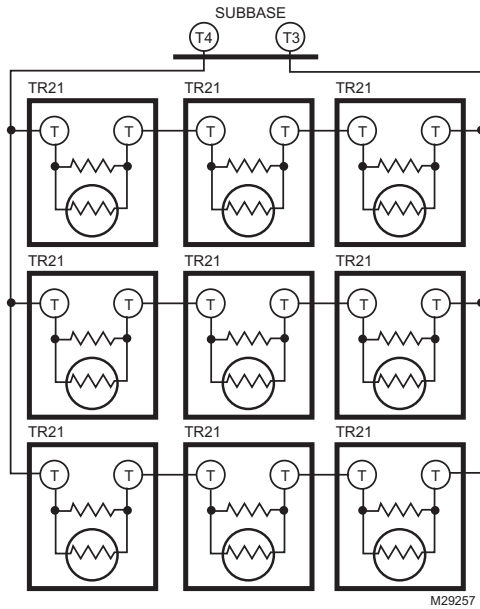

Fig. 5. Nine TR21 Sensors Providing a Temperature Averaging Network for T7351 Thermostat.

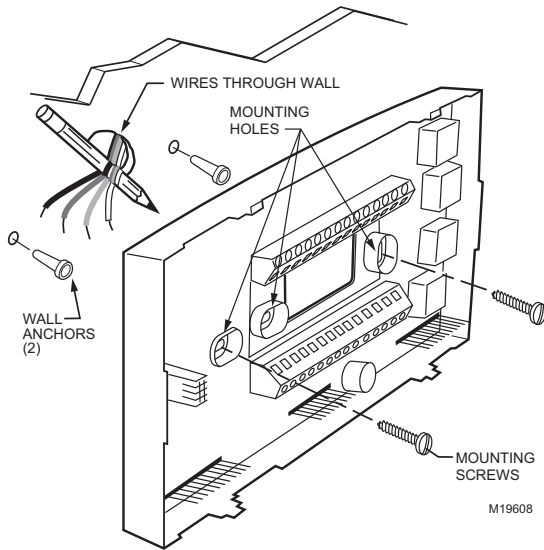

Fig. 6. Mounting the Subbase.

Wiring



CAUTION

Electrical Shock or Equipment Damage Hazard.
Can shock individuals or short equipment circuitry.
 Disconnect power supply before installation.

IMPORTANT

All wiring must comply with local electrical codes and ordinances.

NOTE: Maximum (and recommended) wire size is 18-gauge (ø 1.02 mm). Do not use wire smaller than 22-gauge (ø 0.644 mm).

Follow equipment manufacturer wiring instructions when available. Refer to the Wiring Diagram section for typical hookups. A letter code is located near each terminal for identification. Refer to Tables 3 for terminal designations.

1. Loosen subbase terminal screws and connect system wires.
2. Securely tighten each terminal screw.
3. Push excess wire back into the hole in the wall.
4. Plug the hole with nonflammable insulation to prevent drafts from affecting the thermostat.

Table 3. T7351 Subbase for Three-stage Heat, Three-stage Cool Systems.

Terminal		Description
Conventional	Heat Pump	
RC ^a	RC ^a	24 VAC Cooling transformer.
RH ^a	RH ^a	24 VAC Heating transformer.
X	X	Common.
aux	aux	Auxiliary relay.
W1	O/B	Conventional: Stage 1 heating relay. Heat Pump: Changeover relay for heating (B) or cooling (O) ^b .
W2	W1	Conventional: Stage 2 heating relay. Heat Pump: 1st Stage auxiliary heat relay.
Y1	Y1	Conventional: Stage 1 cooling relay. Heat Pump: Stage 1 compressor relay.
Y2	Y2	Conventional: Stage 2 cooling relay. Heat Pump: Stage 2 compressor relay.
AS	AS	Discharge Air Sensor connection (1).
AS	AS	Discharge Air Sensor connection (2).
OS	OS	Outdoor Air Sensor connection (1).
OS	OS	Outdoor Air Sensor connection (2).
G	G	Fan relay.
T3	T3	TR20 Series Remote Sensor connection (1).
T4	T4	TR20 Series Remote Sensor connection (2).
T5	T5	TR20 Series Remote Sensor connection (5).
T6	T6	TR20 Series Remote Sensor connection (9).
T7	T7	TR20 Series Remote Sensor connection (7).
W3	W2	Conventional: Stage 3 heat or stage 4 cool relay. Heat Pump: 2nd Stage auxiliary heat relay.
Y3	—	Conventional: Stage 3 cooling relay.
HS	HS	Humidity Sensor connection (signal: 0-10 Vdc). TR23-H connection (11)
HC	HC	Humidity Sensor connection (common). ^c
HP	HP	Humidity Sensor connection (power). TR23-H connection (12)
M	M	Motion Sensor connection (1).
M	M	Motion Sensor connection (2).

^a Factory jumper between RC and RH for systems with one transformer.
^b For changeover functional details, see Operation section.
^c HC connection is not needed when using a TR23-H sensor.

Mounting Thermostat on Subbase (Fig. 7)

- With the subbase installed, mount the thermostat:
- Engage the tabs at the top of the thermostat and subbase.
 - Swing the thermostat down.

- Press the lower edge of the case to latch.

NOTE: To remove the thermostat from the wall, first pull out at the bottom of the thermostat; then remove the top.

A. ENGAGE TABS AT TOP OF THERMOSTAT AND SUBBASE OR WALLPLATE.

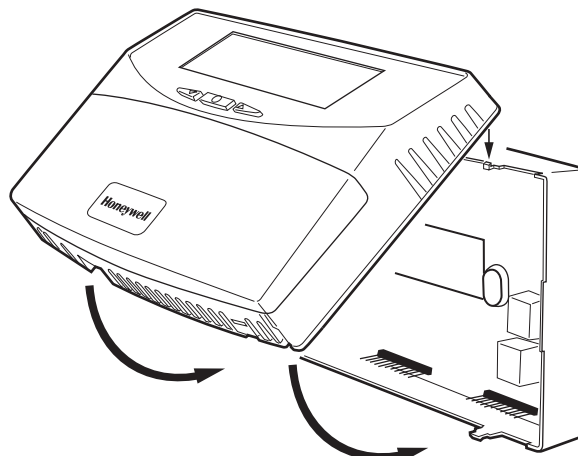

B. PRESS LOWER EDGE OF CASE TO LATCH.

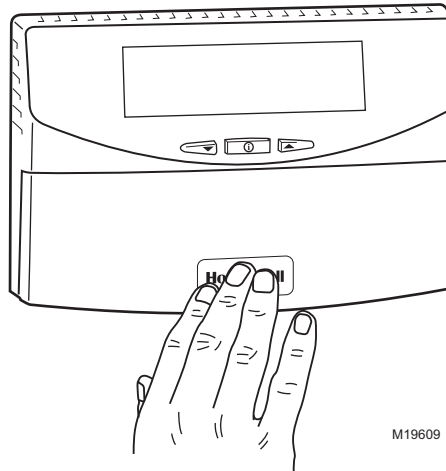

Fig. 7. Mounting Thermostat on Subbase.

SETTING

Using Thermostat Keys

- The thermostat keys are used to:
- set current time and day,
 - program times and setpoints for heating and cooling,
 - override the program temperatures,
 - display present setting,
 - set system and fan operation,
 - perform simple configuration.

NOTE: Refer to Fig. 8 for keypad information.

Setting Temperature

Refer to Table 2 for the default temperature setpoints. See Programming section for complete instructions on changing the setpoints.

Setting System and Fan

System default setting is Auto. Fan default setting is On.

NOTE: Use *System* and *Fan* keys to change settings.

System Settings

- Auto: Thermostat automatically changes between heating and cooling based on indoor temperature.
- Cool: Thermostat controls only cooling.
- Off: Heating, cooling, and fan are all off.
- Heat: Thermostat controls only heating.
- Em Heat: Auxiliary heat serves as first stage. Compressor stages are locked off.

Fan Settings.

- On: See Table 4.
- Auto: Fan always cycles with call for heating or cooling.
 - Conventional: The equipment (i.e. plenum switch) controls fan operation in heat mode. The thermostat controls fan operation in cool mode.
 - Electric Heat: The thermostat controls fan operation in both heat and cool modes.

NOTE: Fan operation can extend (delay Off) after the heating/cooling turns off:

- Heating choices are 0 or 90 seconds.
- Cooling choices are 0 or 40 seconds.

Table 4. T7351 Intelligent™ Fan ON control logic

Occupancy			Call for Heat/Cool		Notes
Scheduled Period	Motion Sensor Signal	Effective Occupancy	Yes	No	
Occupied	No Sensor Wired	Occupied	Fan On	Fan On	
Occupied	Motion Sensed	Occupied	Fan On	Fan On	
Occupied	No Motion Sensed	Standby	Fan On	Fan Off ^a	Effective Occupancy is Standby. Standby setpoints are used and it assumes that the space is unoccupied. Fan is on only when there is a call for heating or cooling.
Not Occupied	No Sensor Wired	Not Occupied	Fan On	Fan Off ^a	Occupancy sensor will only be active during scheduled Occupied periods. During scheduled Not Occupied periods, the effective occupancy will always be Not Occupied.
Not Occupied	Motion Sensed	Not Occupied	Fan On	Fan Off ^a	
Not Occupied	No Motion Sensed	Not Occupied	Fan On	Fan Off ^a	

^a In heat mode, when set for conventional heat, the equipment (i.e. plenum switch) could power the fan despite the T7350.

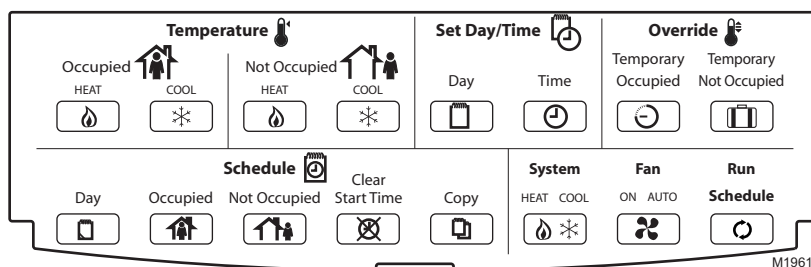

Fig. 8. Thermostat Key Locations.

INSTALLER SETUP

For most applications, the thermostat factory settings do not need to be changed. Review the factory settings in Table 2.

NOTE: When power is first applied to the thermostat, the display will show all segments (See Fig. 9).

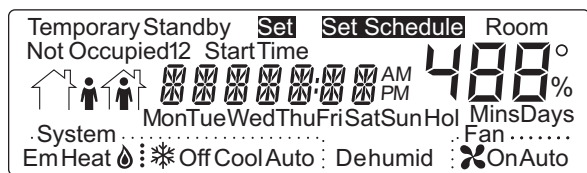

Fig. 9. LCD Display of all Segments.

CAUTION

Possible Equipment Damage.
Fan must be running when system is operating.
 Heat pump and electric heat systems must be configured correctly to prevent equipment damage caused by the system running without the fan.

Setup Using Keypad

The installer uses the Installer Setup to customize the thermostat to specific systems.

A combination of key presses are required to use the Installer Setup features.

- To enter the Installer Setup, press and hold both the *Run Schedule* and the *Copy* keys until DEGREES 00 (or DEGREES 01) displays.

NOTE: Installer Setup will display WAIT and is unavailable for 30 seconds after power up.

- To advance to the next Installer Setup number, press **i**.

NOTE: Pressing *Run/Copy* again while in this mode displays the T7351 firmware version number.

- To return to a Setup item, cycle through the options.
- To change a setting, use the up ▲ or down ▼ key.
- To exit the Installer Setup, press *Run Schedule*.
- Display prompts SAV CFG (save configuration).

- a. If you want to save the new configuration, use the up ▲ or down ▼ key to change NO to YES before pressing *Run Schedule*.
- b. If you want the configuration to remain as it was before starting this change, ensure the display indicates SAV CFG NO and press *Run Schedule*.

NOTE: Installer Setup is automatically exited after five minutes with no key pressed. Upon this automatic exit, all changes are lost.

Configuration

Configuration can be done with the keypad using the Installer Setup (ISU).

Table 5. Installer Setup.

Text	Default	Choices	Notes
DEGREES	0	0 - 1	Degree Temperature Format 0: Degrees F 1: Degrees C
CLOCK	0	0 - 1	Clock Display Format 0: 12 hour 1: 24 hour
KEYLOCK	0	0 - 3	Keypad Lockout Level 0: None 1: Lockout all keys except Set Day, Set Time, Set Date, Set Holidays, Temporary Occupied, Temporary Not Occupied, System, Fan, Up, Down and Information 2: Lockout all keys except Set Day, Set Time, Set Date, Set Holidays, Temporary Occupied, Temporary Not Occupied, Up, Down and Information 3: Lockout all keys except Information
HEATPMP	0	0 - 2	Application Type Selection 0: Conventional 1: Heat Pump - Cooling (Energize O/B on call for cool) 2: Heat Pump - Heating (Energize O/B on call for heat)
COOLSTG	1	0 - 4	Number of Cooling Stages 0: 0 Stages of Cooling 1: 1 Stages of Cooling 2: 2 Stages of Cooling 3: 3 Stages of Cooling (Not available if Heat Pump is selected) 4: 4 Stages of Cooling (W3 will be used as 4th stage relay) (Not available if Heat Pump is selected)
HEATSTG	1	0 - 3	Number of Conventional Heating Stages (Not available if Heat Pump is selected) 0: 0 Stages of Heating 1: 1 Stages of Heating 2: 2 Stages of Heating (This is the max if 4 cooling stages is selected) 3: 3 Stages of Heating
AUX STG	0	0 - 2	Number of Heat Pump Heating Stages (Only shown when Heat Pump is selected) 0: 0 Aux Stages 1: 1 Aux Stages 2: 2 Aux Stages
AUX CON	0	0 - 3	Aux Contact Functionality 0: Time of Day 1: Economizer 2: Dehumid - Hot Gas Bypass 3: Simple Dehumid
WALLMOD	0	0 - 3	Remote Room Sensor Selection 0: Local sensor only 1: TR21/TR24 and T7770A/D (Remote Sensor, No Remote Setpoint, Bypass 0) 2: TR22/TR23 and T7770B/C (Remote Sensor, Remote Setpoint, Bypass 0) 3: T7771 (Remote sensor, Remote Setpoint, Bypass 1) (Bypass 0 means that by pressing the override button the thermostat goes from unoccupied to occupied and the LED will light up and the temporary occupied timer will begin. If the button is pressed again, the timer will restart.) (Bypass 1 means that by pressing the override button a second time the thermostat can return to the unoccupied period.)

Table 5. Installer Setup. (Continued)

Text	Default	Choices	Notes
OATSENS	0	0 - 1	Outdoor Air Sensor Selection 0: None 1: Remote Outdoor Air Sensor
DATSENS	0	0 - 1	Discharge Air Sensor Selection 0: None 1: Remote Discharge Air Sensor
HUMSENS	0	0 - 2	Room Humidity Sensor selection 0: None 1: On Board Sensor 2: Remote Sensor
OCCSENS	0	0 - 1	Occupancy Sensor Selection 0: None 1: Remote Occ Sensor
FAN HT	0	0 - 1	Fan Operation on Heat 0: Conventional (Equipment controls Fan) 1: Electric (Thermostat turns on Fan with call for Heat)
XFAN HT	YES	YES or NO	Extended Fan on Heat NO: None YES: 90 seconds
XFAN CL	NO	YES or NO	Extended Fan on Cool NO: None YES: 40 seconds
STRTDEL	0	0 - 15	Sequential Start Delay 0 to 150 seconds in 10 second increments
ADVANCE	NO	YES or NO	Advanced Settings NO: Hide YES: Show
TMP LIM	3	0 - 5	Temporary Setpoint Adjustment 0: 0 Deg. F 1: 1 Deg. F 2: 2 Deg. F 3: 3 Deg. F 4: 4 Deg. F 5: 5 Deg. F
TMP OCC	3	1 - 8	Temporary Occupied Duration 1 to 8 hours
TMP CAL	0	-4 - 3	Temporary Display Adjustment 0 - 3 = 0 to 3 DDF 4 - 7 = -4 to -1 DDF
MINCOOL	45° F (7° C)	45° - 99° F (7° - 37° C)	Min Cool Setpoint
MAXHEAT	90° F (32° C)	40° - 90° F (4° - 32° C)	Max Heat Setpoint
HEATLCK	NO	YES or NO	Heating Lockout (Only displayed if Outdoor Air Sensor is selected) NO: None YES: Enabled
HTLCKSP	70° F (21° C)	-40° - 120° F (-40° - 49° C)	Heating Lockout Temperature (Display only if Remote Outdoor Air Sensor is configured)
COOLLCK	NO	YES or NO	Cooling Lockout (Only displayed if Outdoor Air Sensor is Selected) NO: None YES: Enabled
CLLCKSP	35° F (2° C)	-40° - 120° F (-40° - 49° C)	Cooling Lockout Temperature (Display only if Remote Outdoor Air Sensor is configured)
DAT LL	NO	YES or NO	Discharge Low Limit (Only displayed if Discharge Air Sensor is Selected) NO: None YES: Enabled
DATLLSP	45° F (7° C)	35° - 60° F (2° - 16° C)	Discharge Low Temp Limit (Display only if Discharge Sensor is configured)

Table 5. Installer Setup. (Continued)

Text	Default	Choices	Notes
DAT HL	NO	YES or NO	Discharge High Limit (Only displayed if Discharge Air Sensor is Selected) NO: None YES: Enabled
DATHLSP	110° F (43° C)	65° - 140° F (18° - 60° C)	Discharge High Temperature Limit (Display only if Discharge Sensor is configured)
DEHUMID	0	0 - 5	Dehumidification 0: None 1: MinOn Time 2: Reset Temp Setpoint 3: Reset w/ MinOn 4: Reheat 5: Reheat w/ Min On
DEH MIN	5	5 - 15	Dehumidify Minutes On
DEH TMP	2	1 - 5	Dehumidify Temp Reset
MINHTRT	5	0 - 20 DDF/HR	Minimum Heat Recovery Ramp Rate
MAXHTRT	8	0 - 20 DDF/HR	Maximum Heat Recovery Ramp Rate (Only Displayed if Outdoor Sensor is Selected)
MINHTOA	0° F (-18° C)	-20° - 120° F (-29° - 49° C)	Minimum Heat Outdoor Air Temperature (Only Displayed if Outdoor Sensor is Selected)
MAXHTOA	40° F (4° C)	-20° - 120° F (-29° - 49° C)	Maximum Heat Outdoor Air Temperature (Only Displayed if Outdoor Sensor is Selected)
MINCLRT	3	0 - 20 DDF/HR	Minimum Cool Recovery Ramp Rate
MAXCLRT	6	0 - 20 DDF/HR	Maximum Cool Recovery Ramp Rate (Only Displayed if Outdoor Sensor is Selected)
MINCLOA	90° F (32° C)	-20° - 120° F (-29° - 49° C)	Minimum Cool Outdoor Air Temperature (Only Displayed if Outdoor Sensor is Selected)
MAXCLOA	70° F (21° C)	-20° - 120° F (-29° - 49° C)	Maximum Cool Outdoor Air Temperature (Only Displayed if Outdoor Sensor is Selected)
			(DayLight Savings options only display when Date is valid)
DSTMON1	3	0 - 12	DLS Spring Month
DSTDAY1	40	0 - 31, 32 - 74	DLS Spring Day 0 - 31 = Day of Month 32 = Last Day of Month 33 = First Sunday etc...
DSTMON2	11	0 - 12	DLS Fall Month
DSTDAY2	33	0 - 31, 32 - 74	DLS Fall Day 0 - 31 = Day of Month 32 = Last Day of Month 33 = First Sunday etc...
HT RESP	1	0 - 3	0: Standard - 3 cph 1: Medium - 6 cph 2: Fast - 9 cph 3: Super Fast - 20 cph
CL RESP	0	0 - 1	0: Standard - 3 cph 1: Fast - 4 cph

Holidays and 365 - Day Clock

The T7351 can be configured to schedule up to 10 separate holidays, each with a duration of up to 99 days. To enable this function, the user must set the date:

1. Press Set Day and Set Time keys simultaneously.
2. Use the Up/Down keys to set the date to YES, then press the **i** key.
3. Use the Up/Down keys to set the month, then press the **i** key.

4. Use the Up/Down keys to set the day, then press the **i** key (Refer to Table 4 for valid day choices).
5. Use the Up/Down keys to set the year, then press the **i** key.

Holidays can be set in the following manner:

1. Press the "Temporary Occupied" and Temporary Not Occupied" keys simultaneously.
2. The month (MON) of the first holiday is then displayed (00 means the holiday is ignored).
3. Use the Up/Down keys to set the month, then press the **i** key.



4. Use the Up/Down keys to set the day, then press the  The first holiday is now set and pressing the  key will take you to programming the second holiday (denoted by the number 2 on the screen)
5. Use the Up/Down keys to set the duration.

Table 6. Valid Day Values.

Value	Description		Value	Description			
1 to 31	Day of month	42	Second Tuesday	53	Third Saturday	64	Fifth Wednesday
32	Last Day of Month	43	Second Wednesday	54	Fourth Sunday	65	Fifth Thursday
33	First Sunday	44	Second Thursday	55	Fourth Monday	66	Fifth Friday
34	First Monday	45	Second Friday	56	Fourth Tuesday	67	Fifth Saturday
35	First Tuesday	46	Second Saturday	57	Fourth Wednesday	68	Last Sunday
36	First Wednesday	47	Third Sunday	58	Fourth Thursday	69	Last Monday
37	First Thursday	48	Third Monday	59	Fourth Friday	70	Last Tuesday
38	First Friday	49	Third Tuesday	60	Fourth Saturday	71	Last Wednesday
39	First Saturday	50	Third Wednesday	61	Fifth Sunday	72	Last Thursday
40	Second Sunday	51	Third Thursday	62	Fifth Monday	73	Last Friday
41	Second Monday	52	Third Friday	63	Fifth Tuesday	74	Last Saturday

Table 7. T7351 Key Function Summary.

























Grouping	Button	Definition
Information	Down Arrow 	Lowers setpoint, day, or time. When setting times or temperatures, hold key down to continuously decrease value. Also can make temporary change in temperature setpoint.
	Information 	Obtains information (where humidity “high-limit” can be set), cycles through setup options.
	Up Arrow 	Raises setpoint, day, or time. When setting times or temperatures, hold key down to continuously increase value. Also can make temporary change in temperature setpoint.
Temperature 	Occupied Heat 	Sets Occupied Heat setpoint.
	Occupied Cool 	Sets Occupied Cool setpoint.
	Not Occupied Heat 	Sets Not Occupied Heat setpoint.
	Not Occupied Cool 	Sets Not Occupied Cool setpoint.
Set 	Day 	Sets day of week. Tapping key with ‘Set Value’ segment on increases current day (same effect as <i>Up Arrow</i> key).
	Time 	Sets time. Tapping key with “Set Value” segment on increases time in one hour increments.
Override 	Temporary Occupied 	Temporary occupied setting for length of time defined by installer. User can modify setpoints.
	Temporary Not Occupied 	Sets holiday length. User selects number of days (“0”-“99”), or “---” for continuous override.
Schedule 	Day 	Selects day schedule to modify. (Used also with copy key.)
	Occupied 	Selects occupied event start times for specified day. Repeatedly press this key to toggle between two occupied events.
	Not Occupied 	Selects not occupied event start times for specified day. Repeatedly press this key to toggle between two not occupied events.
	Clear Start Time 	Clears start time for specified period and day.
	Copy 	Copies schedule from one day to another.
	System 	Selects System Mode. Toggles through Em Heat, Off, Cool, and Auto.

Table 7. T7351 Key Function Summary. (Continued)

Grouping	Button	Definition
Schedule 	Fan 	Selects fan operation mode. Toggles between On and Auto. ^a
	Run Schedule 	Resumes running schedule (cancels Temporary Occupied action, Holiday, and/or Temporary setpoint changes.)

^a On: Continuous fan operation during occupied periods. During not occupied periods and in standby mode when no motion is sensed, fan cycles with call for heat or cool.

Auto: Fan cycles with call for heat or cool during all periods. (See Product Data Sheet, form 63-2605, for more details).

NOTES: The display returns to default screen after pressing Run Schedule (or after a period of time without keypress):

- ten seconds: when returning from temporary setpoint changes, info screen, temp occ, and temp not occ.
- one minute: when returning from setting clock/day.
- ten minutes: when returning from System Checkout.
- five minutes: when returning from all other modes.

Special Functions

Restore Factory Configuration (Run/Clear)

IMPORTANT

This operation erases current configuration and restores factory defaults for all configuration, parameters, setpoints and schedules. To regain the old requires device reconfiguration.

1. Press both *Run Schedule* and *Clear Start Time*.
2. The display gives the option to revert to FAC CFG.
 - a. To restore the factory defaults, press up ▲ or down ▼ until the display indicates YES.
 - b. To cancel this option, ensure the display indicates NO.
3. Press *Run Schedule*.

Get Factory Schedule (Info/Clear)

Performing this operation reverts the schedules to the factory defaults:

1. Press both *Info* and *Clear Start Time*.
2. The display gives the option to revert to FAC SCH.
 - a. To restore the factory schedule, press up ▲ or down ▼ until the display indicates YES.
 - b. To cancel this option, ensure display indicates NO.
3. Press *Run Schedule*.

Test Mode (Occupied/Not Occupied/Schedule Day)



CAUTION

Possible Equipment Damage.
Equipment damage can result if compressor is cycled too quickly.

The minimum off time for compressors is bypassed during Test Mode. Equipment damage can occur if the compressor is cycled too quickly.

Use the Test Mode to check the thermostat configurations and operation. To start the system test:

1. Press *Schedule Day, Occupied* and *Not Occupied* simultaneously.
2. The display gives the option to TEST.

- a. To enter test mode, press up ▲ or down ▼ until the display indicates IN TEST.
 - b. To cancel this option, ensure display indicates NO TEST.
3. Press *Run Schedule*.

NOTES:

- To verify whether or not the system test is still active, repeat the above process.
- The system test times out after ten minutes with no key pressed.

Save User Schedule (Info/Copy)

Performing this operation saves the current schedule (including holidays) to memory, overwriting the old saved schedule:

1. Press both *Info* and *Copy*.
2. The display gives the option to revert to SAV SHD.
 - a. To save the current schedule, press up ▲ or down ▼ until the display indicates YES.
 - b. To cancel this option, ensure display indicates NO.
3. Press *Run Schedule*.

Get User Schedule (Info/Run)

Getting the user schedule restores the schedule (including holidays) from saved memory, overwriting the schedule currently in use:

1. Press both *Run Schedule* and *Info*.
2. The display gives the option to GET SHD.
 - a. To retrieve the saved schedule, press up ▲ or down ▼ until the display indicates YES.
 - b. To cancel this option, ensure display indicates NO.
3. Press *Run Schedule*

OPERATION

Startup Operation

Upon initial thermostat power-up, a startup and initialization program begins. This startup occurs only on initial power-up. After total loss of power for an extended period, the current time and day can be lost (requiring reset). However, the thermostat retains the user program.

NOTE: With no program set, the thermostat controls to the Occupied default setpoints of 70° F (21° C) for heat and 75° F (24° C) for cool.

T7351 Relay Logic

All T7351 model thermostats contain at least four switching relays. In conventional applications, the relays control first stage cooling, first stage heating, fan, and auxiliary. In heat pump applications, the relays control the heat pump compressor, changeover, fan, and emergency heat.

O/B Terminal for Heat or Cool Changeover

The O/B terminal controls heat pump changeover. The default operation is for the terminal to be powered when calling for heat (or while the most recent call was for heat). This corresponds to a typical B terminal.

NOTE: The O/B terminal can be configured to operate as a typical O terminal (powered on call for cool).

Emergency Heat

With the system set for *Em Heat*, auxiliary heat serves as stage one; compressor stages are locked off. The fan cycles with the auxiliary heat.

Equipment Protection

As part of the operational sequence, the T7351 microprocessor incorporates cycle rate, and minimum on and off times for all heating and cooling stages. This extends equipment life as it prevents rapid cycling of equipment.

NOTE: Minimum on and off times are fixed.

Cycle Rates

The thermostat control algorithm maintains the temperature by cycling stages of heating or cooling to meet setpoint. Cycle rates, in cycles per hour (cph) are set in the installer setup.

NOTE: Defaults are: heat: 6cph, cool: 3cph.

P+I+D Control

The T7351 microprocessor-based control requires that the user understands temperature control and thermostat performance. A conventional electromechanical or electronic thermostat does not control temperature precisely at setpoint. Typically, there is an offset (droop) in the control point as the system load changes. This is a phenomenon that most people in the industry know and accept.

IMPORTANT

- *P+I+D (Loop Tuning) parameters are optimized for proper operation of a vast majority of HVAC systems. Only when completely certain of necessary and proper changes should you alter these values.*
- *Improper changes result in poor system performance and equipment problems such as compressor short cycling. Other problems include wide swings in space temperature and excessive overdriving of modulating outputs.*

All adjustments to Loop Tuning parameters should be gradual. After each change, allow the system to stabilize to accurately observe the effects of the change. Then, as needed, make further refinements until the system operates as desired.

If adjustment of PID parameters is required, use the following:

NOTE: In the items that follow, the term “error” refers to the difference between the measured space temperature and the current actual space temperature setpoint:

- The **Throttling Range (TR)**, also called Proportional Gain, determines the impact of the error on the output signal. Decreasing TR amplifies the error effect; that is, for a given error, smaller TR causes higher output signal.
- The **Integral Time (IT)**, also called Integral Gain, determines the impact of the error-over-time on the output signal. Error-over-time has two components making up its value: amount of time the error exists; and size of the error. The higher the IT, the slower the control response. In other words, a decrease in IT causes a more rapid change to the output signal.
- The **Derivative Time (DT)**, also called Derivative Gain, determines the impact of the error rate on the output signal. The error rate is how fast the error value changes. It can also be the direction the space temperature is going, either toward or away from the setpoint, and its speed—rapid or slow. A decrease in DT causes, for a given error rate, a greater effect on output signal.

Recovery Ramping Logic

The T7351 incorporates a ramping feature that gradually changes the space setpoints. During recovery operation, the setpoint changes at a rate in degrees per hour depending on the outdoor air temperature. If there is no outdoor air temperature sensor available, the minimum ramp rate is used.

When recovering in heating, the control point raises gradually, maximizing the use of the more economical first stage heat to bring the sensed temperature to the desired comfort setpoint. This minimizes using the typically more expensive later stage(s) of heat.

NOTE: See Fig. 10 for a pictorial representation of the heat ramp rate determination.

Recovery Ramping for Conventional Systems

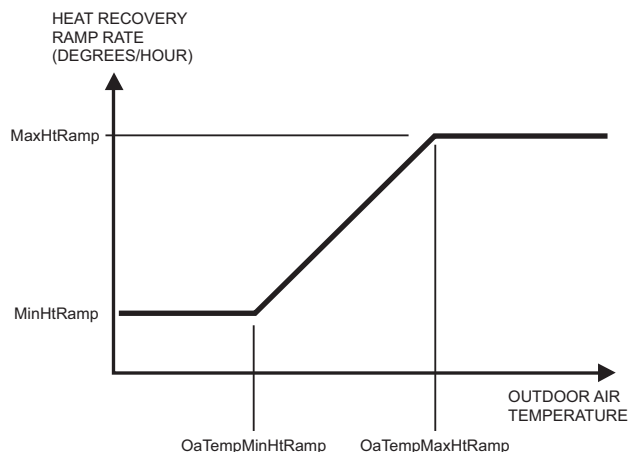

Fig. 10. Heat Setpoint Ramping for Conventional Systems.

NOTES:

- Recovery ramping applies between scheduled heat or cool setpoint changes from not occupied to standby and not occupied to occupied.
- Other setpoint changes use a setpoint step change.

Recovery Ramping for Heat Pump Systems

During recovery with heat pump equipment, the heating setpoint is split into a heat pump setpoint for compressors, and two auxiliary heat setpoints for the auxiliary heat stages. (Refer to Fig. 11 for the various setpoints.)

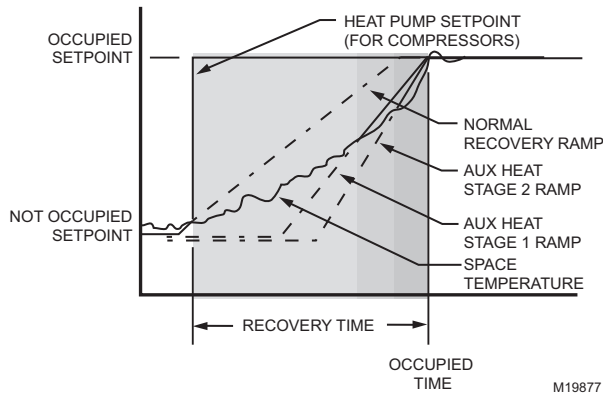

Fig. 11. Heat Setpoint Ramping for Heat Pump Systems.

Heat pump ramping for heating proceeds as follows:

1. The heat pump setpoint begins to ramp until the room temperature and the compressor ramp intersect.
 2. At this point, the heat pump setpoint performs a step change to the Occupied (or Standby) setpoint and all auxiliary heat stages are disabled.
- NOTE: The heat pump setpoint remains here for the rest of the Not Occupied period.
3. The stage one auxiliary heat ramp is calculated based on a steeper slope starting 1° F (0.5° C) below the not occupied setpoint.
 4. When the room temperature intersects this auxiliary heat ramp, the first stage of auxiliary heat is enabled.
 5. The stage two auxiliary heat ramp is calculated based on an even steeper slope starting 2° F (1° C) below the not occupied setpoint.
 6. When the room temperature intersects this auxiliary heat ramp, the second stage of auxiliary heat is enabled.

During the cool recovery period, the setpoint changes at a rate in degrees per hour relative to the outdoor air temperature. If there is no outdoor air temperature sensor available, the minimum ramp rate is used.

See Fig. 12 for the various setpoints.

NOTE: For cooling, the same method is used in both conventional and heat pump systems.

NOTE: The setpoint used during the cool recovery period is similar to the heat mode in Fig. 10, except the slope of the line reverses for cooling.

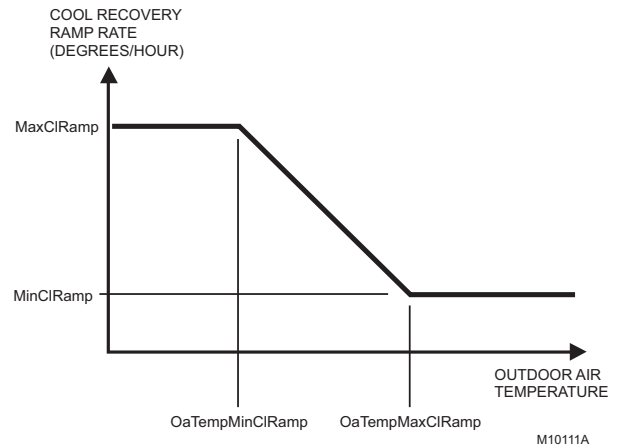

Fig. 12. Setpoint Ramping Parameters with Ramp Rate Calculation.

Advantages:

- Comfort setting is achieved at the programmed time and maintained regardless of weather conditions; occupants are comfortable.
- Drafts from low-temperature discharge air are minimized during Occupied periods.
- Use of the more economical first stage of heat is maximized during recovery, minimizing use of the expensive later heat stage(s).
- Comfort and energy savings can be achieved in both heating and cooling.
- Heat cycling reduced, extending equipment life.

Auxiliary Relay

The auxiliary relay can be used with a variety of controls:

- Time-of-day (TOD).
- Economizer minimum position control.
- Dehumidification (see Dehumidification section).

Relay for Time-Of-Day (Table 8)

Time-of-day (TOD) is the Auxiliary Relay default configuration.

TOD logic operates strictly according to programming:

- Occupied: Relay contacts closed.
- Not Occupied: Relay contacts open.
- Standby (Scheduled): Relay contacts closed.

Relay for Economizers

Mechanical cooling is often used with outside temperatures in the 50° F (10° C) to 60° F (16° C) range and humidity below 50 percent. In central and northern climates, hundreds of hours fall into this temperature category. By permitting 80 to 100 percent outside air into the system, mechanical cooling may not be needed at all, particularly during Spring and Fall.

Economizers take advantage of outside air. The typical economizer consists of an outside air damper, motor, outdoor air changeover control and a minimum position potentiometer. The motor controls the dampers. Suitability of the outside air for cooling is determined by the outdoor air changeover control.

The potentiometer adjusts the minimum position of the economizer dampers, which provide a minimum amount of fresh air for ventilation.

The economizer reduces compressor run time, thereby saving energy and extending compressor life. The drawback to using the economizer is that during the Not Occupied period, if there is no call for cool or outdoor air is not suitable for free cooling, the economizer is controlled to minimum position. This position allows some percentage of outdoor air to enter the building, regardless of air suitability. The situation can cause the heating or cooling to run more often than when only suitable air is permitted to enter the building.

The T7351 can take advantage of an economizer by closing the auxiliary relay contacts to control the economizer minimum position potentiometer. (See Table 8 for details.)

- Powered: Allows normal economizer operation.
- Unpowered: Disables the economizer minimum position. The lack of power causes the economizer to drive dampers fully closed instead of staying at minimum open position. This reduces the possibility of unsuitable outdoor air entering the building, which lowers the internal load on the HVAC system and saves additional energy.

Table 8. T7351 Auxiliary Relay Logic (Economizer and TOD)

Occupancy			Auxiliary Contacts		Notes
Scheduled Period	Motion Sensor Signal	Effective Occupancy	Economizer	TOD	
Occupied	No Sensor Wired	Occupied	Closed ^b	Closed	
Occupied	Motion Sensed	Occupied	Closed ^b	Closed	
Occupied	No Motion Sensed	Standby	Open; Closed only during calls for cool ^a	Open	Effective Occupancy is Standby. Standby setpoints are used and it assumes that the space is unoccupied. Economizer relay is energized only on calls for cooling.
Not Occupied	No Sensor Wired	Not Occupied	Open; Closed only during calls for cool ^a	Open	Occupancy sensor will only be active during scheduled Occupied periods. During scheduled Not Occupied periods, the effective occupancy will always be Not Occupied.
Not Occupied	Motion Sensed	Not Occupied	Open; Closed only during calls for cool ^a	Open	
Not Occupied	No Motion Sensed	Not Occupied	Open; Closed only during calls for cool ^a	Open	

^a Unless otherwise noted, Economizer logic ignores calls for heat. The Economizer relay will be energized during calls for cooling.

^b With fan set to AUTO and call for neither heat nor cool, the relay is open in order to disable damper minimum position.

Other Uses for the Auxiliary Relay

Examples of other uses of the auxiliary relay are hot water heaters, lighting, or baseboard heat. The additional loads are connected to the auxiliary relay contacts on the subbase. The contacts are rated for 1.5A at 30 Vac, but can be adapted to higher current applications using an external relay (See Fig. 13).

Default Auxiliary Relay Operations

Unless configured as a stage of heating or cooling, terminals W2, W3, and Y3 operate for specific auxiliary functions. Each output takes on different auxiliary functions depending on configuration for Conventional or Heat Pump operation. See Table 9 for details.

NOTE: The default functions cannot be modified. They are limited to firmware version 1.3.0 or higher.

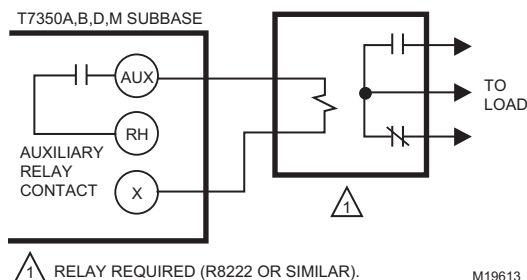

Fig. 13. Using T7351 Models with an External Relay (with loads greater than 1.5A).

Table 9. Default Auxiliary Relay Operations.

Heat Pump or Conventional	Contact Not Used as Heat or Cool Stage	Contact Configuration of Contact Not Used as Stage			
		Simple Dehumidification ^a	Simple Dehumidification ^a	Time of Day	Time of Day
Heat Pump	Y3	Simple Dehumidification ^a	Simple Dehumidification ^a	Time of Day	Time of Day
	W2 not aux heat	Economizer	Time of Day	Economizer	Economizer
Conventional	W3 not	Simple Dehumidification ^a	Simple Dehumidification ^a	Simple Dehumidification ^a	Time of Day
	Y3 not (W3 not)	Economizer	Time of Day	Time of Day	Economizer
	Y3 not (W3 used)	Simple Dehumidification ^a	Simple Dehumidification ^a	Simple Dehumidification ^a	Time of Day

	↑	↑	↑	↑
Auxiliary Contact Configuration	Time of Day	Economizer	Hot Gas Bypass Dehumidification	Simple Dehumidification ^a

^aSimple dehumidification uses a normally closed contact. The relay is closed when humidity is below the high limit. When the humidity is above the high limit, the contact is open.

Dehumidification

There are five methods through which the T7351 can control for dehumidification. Three of them modify the control algorithm, thus providing limited dehumidification through cooling. The other two use the auxiliary output to control another device.

NOTE: The dehumidification high limit can be set within the range of 10 to 90 percent relative humidity.

Control Through Cooling

Configure using some combination of the following:

- Minimum On.
- Reheat.
- Reset.

NOTES:

- These methods operate only during cooling.
- Selecting both Reheat and Reset can cause frequent setpoint adjustments. This selection is not recommended.

MIN ON TIME

Dehumidifies by increasing the compressor minimum on time (normally 3 minutes) by a programmable amount. This is useful with oversized systems in that it forces the coils to cool to a point where dehumidification can occur.

NOTES:

- Can force wider temperature swings by cooling when setpoint control does not require it.
- The minimum on time can be set within the range of 5 to 15 minutes.
- Hysteresis and a minimum timer are used to ensure this behavior does not change with every equipment cycle.

REHEAT

Dehumidifies by operating cooling during typical off time. The T7351 maintains the proper setpoint by running the heat at the same time.

IMPORTANT

At times during Reheat dehumidification, the T7351 operates heating and the cooling simultaneously. This is normal.

NOTES:

- The heat stage never energizes during Reheat if more than one cool stage is on.
- Reheat mode cannot occur during heating.

RESET TEMP SETPT

The room temperature set point resets to a specified number of degrees below the actual set point when room relative humidity (RH) rises above humidity high limit. The default value is 2 degrees.

Though this may not technically reduce RH, it reduces the dew point to provide the customer with a sense of comfort due to a lower temperature setting in the room.

As long as RH stays above humidity high limit, this set point is maintained.

NOTE: Hysteresis and a minimum timer prevent the set point from short interval alternation (between standard and reset set points).

Options Utilizing Auxiliary Output

There are two dehumidification options that utilize the auxiliary output. They are:

- Simple Dehumidification.
- Hot Gas Bypass Dehumidification.

SIMPLE DEHUMID(IFICATION)

The auxiliary output:

- Energizes when RH rises above humidity high limit.
- De-energizes when RH drops below humidity high limit.

NOTES:

- 5% Hysteresis and a minimum timer prevent short cycling of this output.
- Unlike Dehumid Hot Gas BP the relay remains energized during calls for multiple cooling stages.

DEHUMID HOT GAS BP

The auxiliary output operates as shown in Table 10.

Table 10. Hot Gas Bypass Dehumidification Logic.

Humidity	Cooling Stages Active	Auxiliary Output
High	more than one	De-energized
High	one or less	Energized
Low	more than one	De-energized
Low	one or less	De-energized

Auxiliary output during call for multiple cooling stages for two reasons:

1. This method assumes that the cooling provides dehumidification.
2. Multiple cooling stages probably provide necessary dehumidification.

NOTE: Hysteresis and a minimum timer prevent short cycling of this output.

TROUBLESHOOTING GUIDE (TABLE 11)

Table 11. Troubleshooting Information.

Symptom	Possible Cause	Action
Display will not come on.	Thermostat is not being powered.	Check that X terminal is connected to the system transformer. Check for 24 Vac between X and RH or RC terminals. If missing 24 Vac: <ul style="list-style-type: none"> • Check if circuit breaker is tripped; if so, reset circuit breaker. • Check if system fuse is blown; if so, replace fuse. • Check if the HVAC equipment power switch is in the Off position; if so, set to the On position. • Check wiring between thermostat and HVAC equipment. Replace broken wires and tighten loose connections. If 24 Vac is present, proceed with troubleshooting.
	Temperature display is incorrect.	Thermostat is configured for ° F or ° C display. Press both <i>Run Schedule</i> and <i>Copy</i> , then reconfigure the display.
	Bad thermostat location.	Relocate the thermostat.
Temperature settings will not change. (Example: Cannot set heating higher or cooling lower.)	Display shows three dashes and a degree sign (all systems shut down).	T7351 is set for the remote sensing and sensor is missing or circuit is either open or shorted.
	Upper or lower temperature limits were reached.	Check the temperature setpoints: <ul style="list-style-type: none"> • Heating limits are 40° to 90° F (4° to 32° C) • Cooling limits are 45° to 99° F (7° to 37° C)
	Occupied setpoint temperature range stops were configured.	Check setpoint stops. If necessary, reconfigure the stop(s).
Room temperature is out of control.	Keypad is locked. When a locked key is pressed, LOCKED appears momentarily on the LCD.	Change keypad lock level.
	Remote temperature sensing is not working.	Check all remote sensors.
Heat will not come on.	No power to the thermostat.	Check that X terminal is connected to the system transformer. Check for 24 Vac between X and RH terminals. If missing 24 Vac: <ul style="list-style-type: none"> • Check if circuit breaker is tripped; if so, reset circuit breaker. • Check if system fuse is blown; if so, replace fuse. • Check if the HVAC equipment power switch is in the Off position; if so, set to the On position. • Check wiring between thermostat and HVAC equipment. Replace broken wires and tighten loose connections. If 24 Vac is present, proceed with troubleshooting.
	Thermostat minimum off time is activated.	<ul style="list-style-type: none"> • Wait up to five minutes for the system to respond. • Configure heating response.
	System selection is set to Off or Cool.	Set system selection to Heat or Auto.
	DAT high limit has been reached, or OAT lockout is engaged.	<ul style="list-style-type: none"> • If the setpoints are correct, do nothing. • Adjust or disable DAT high limit and/or OAT lockout. • Check HVAC equipment to ensure proper operation.

Table 11. Troubleshooting Information. (Continued)

Symptom	Possible Cause	Action
Cooling will not come on.	No power to the thermostat.	Check that X terminal is connected to the system transformer. Check for 24 Vac between X and RC terminals. If missing 24 Vac: <ul style="list-style-type: none"> • Check if circuit breaker is tripped; if so, reset circuit breaker. • Check if system fuse is blown; if so, replace fuse. • Check if the HVAC equipment power switch is in the Off position; if so, set to the On position. • Check wiring between thermostat and HVAC equipment. Replace broken wires and tighten loose connections. If 24 Vac is present, proceed with troubleshooting.
	Thermostat minimum off time is activated.	<ul style="list-style-type: none"> • Wait up to five minutes for the system to respond. • Configure cooling response.
	System selection is set to Off or Heat.	Set system selection to Cool or Auto.
	DAT low limit has been reached, or OAT lockout is engaged.	<ul style="list-style-type: none"> • If the setpoints are correct, do nothing. • Adjust or disable DAT low limit and/or OAT lockout. • Check HVAC equipment to ensure proper operation.
System indicator (flame: heat, snowflake: cool) is displayed, but no warm or cool air is coming from the registers.	The call for heat or cool is not yet given.	Check if any stage indicators (dots next to the system indicator) are displayed. With no display of stage indicators, no call for cool/heat via relay is yet given.
	Conventional heating equipment turns the fan on only after the furnace has warmed to a setpoint.	Wait one minute after seeing the on indicator and then check the registers.
	Heating or cooling equipment is not operating.	Verify operation of heating or cooling equipment in Test Mode.

WIRING DIAGRAM (FIGURES 14 AND 15)

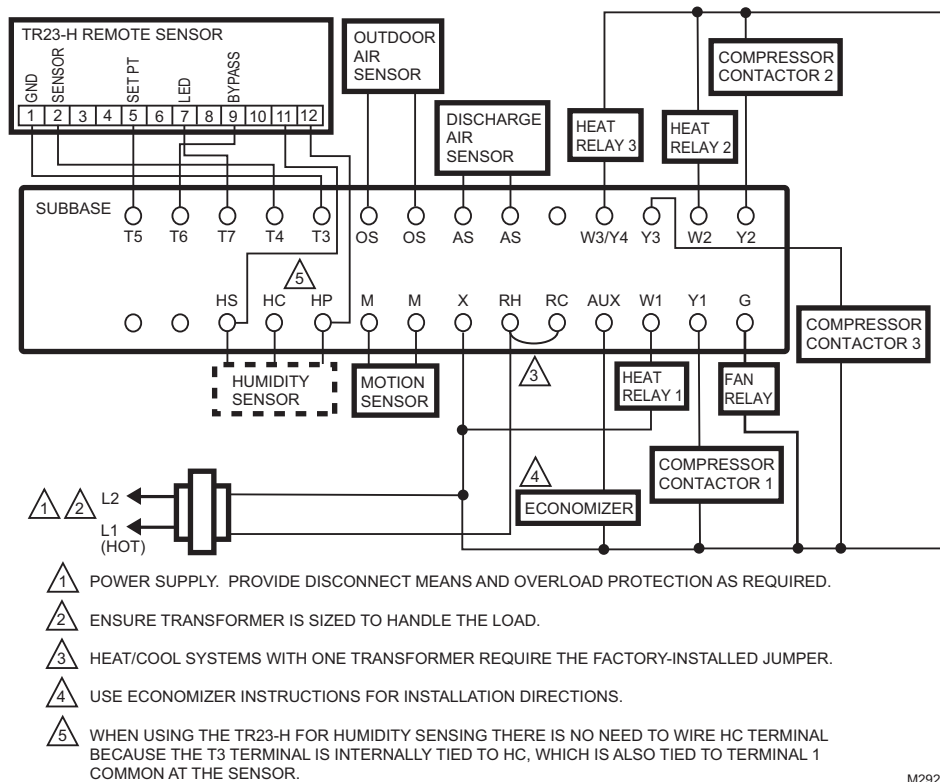

M29255

Fig. 14. Typical Hookup of T7351F2010 in Three-Stage Heat and Three-Stage Cool Conventional System with One Transformer.

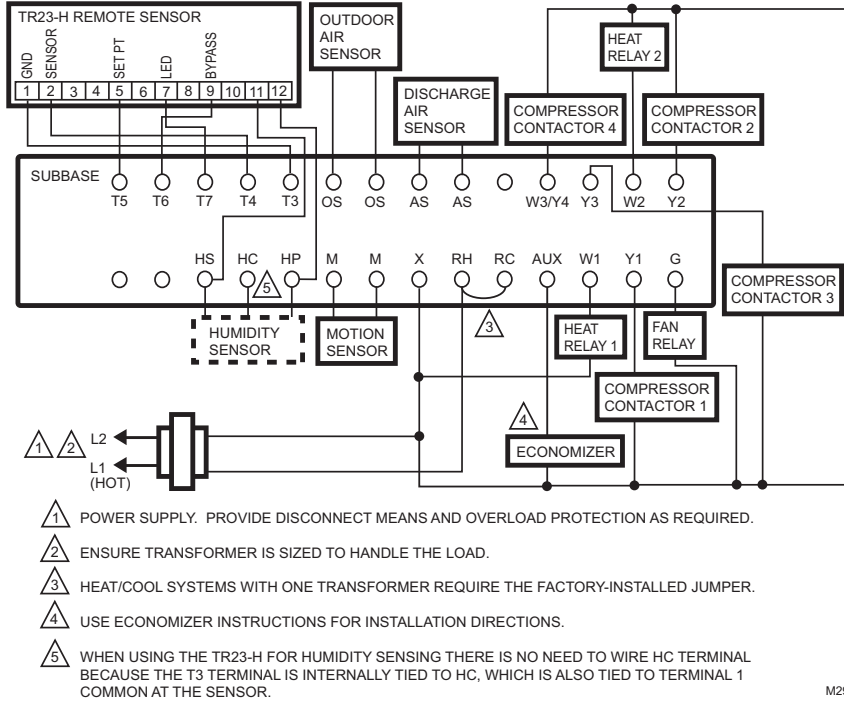

M29254

Fig. 15. Typical Hookup of T7351F2010 in Two-Stage Heat and Four-Stage Cool Conventional System.

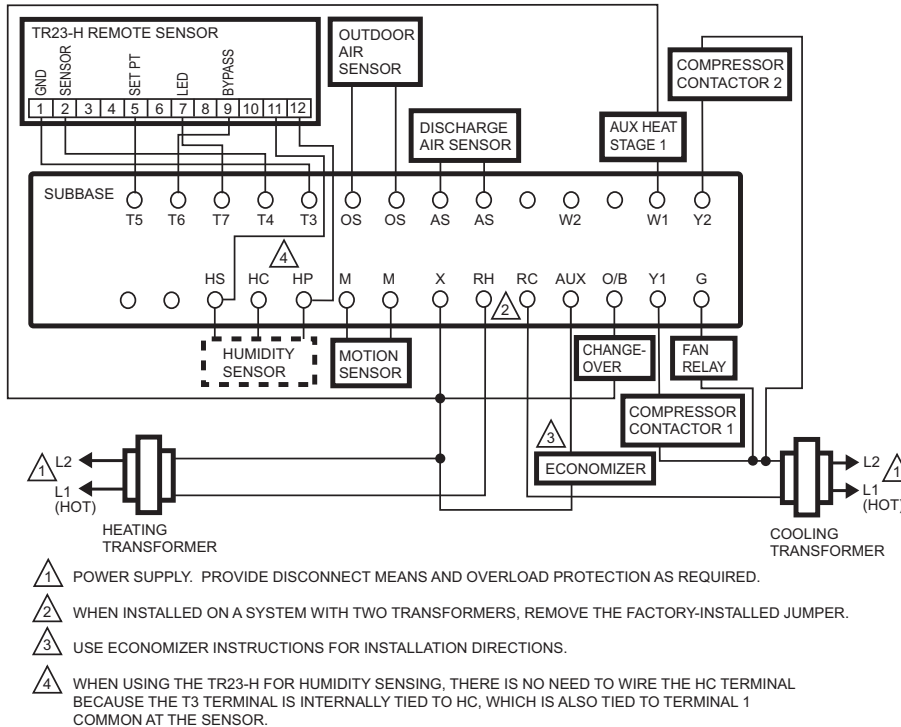

M29323

Fig. 16. Typical hookup of T7351F2010 in two-stage heat and two-stage cool heat pump system with two transformers.

Automation and Control Solutions

Honeywell International Inc.
 1985 Douglas Drive North
 Golden Valley, MN 55422
 customer.honeywell.com



© U.S. Registered Trademark
 © 2013 Honeywell International Inc.
 63-2666-03 M.S. Rev. 12-13
 Printed in United States

By using this Honeywell literature, you agree that Honeywell will have no liability for any damages arising out of your use or modification to, the literature. You will defend and indemnify Honeywell, its affiliates and subsidiaries, from and against any liability, cost, or damages, including attorneys' fees, arising out of, or resulting from, any modification to the literature by you.