

Compact (HBH/V) Series

HBH-HBV 006-60

60Hz - HFC-410A

Comfort-Aire  **Century**

Table of Contents

	*Page Number
Unit Features	4
Selection Procedure	5
HB Series Nomenclature	7
Performance Data – AHRI/ASHRAE/ISO 13256-1	8
Performance Data – Selection Notes	9
Performance Data – HBH/V 006 (PSC Blower)	10
Performance Data – HBH/V 009 (PSC Blower)	11
Performance Data – HBH/V 012 (PSC Blower)	12
Performance Data – HBH/V 015 (PSC Blower)	13
Performance Data – HBH/V 015 (ECM Blower)	14
Performance Data – HBH/V 018 (PSC Blower)	15
Performance Data – HBH/V 018 (ECM Blower)	16
Performance Data – HBH/V 024 (PSC Blower)	17
Performance Data – HBH/V 024 (ECM Blower)	18
Performance Data – HBH/V 030 (PSC Blower)	19
Performance Data – HBH/V 030 (ECM Blower)	20
Performance Data – HBH/V 036 (PSC Blower)	21
Performance Data – HBH/V 036 (ECM Blower)	22
Performance Data – HBV 041 (PSC Blower)	23
Performance Data – HBH/V 042 (PSC Blower)	24
Performance Data – HBH/V 042 (ECM Blower)	25
Performance Data – HBH/V 048 (PSC Blower)	26
Performance Data – HBH/V 048 (ECM Blower)	27
Performance Data – HBH/V 060 (PSC Blower)	28
Performance Data – HBH/V 060 (ECM Blower)	29
Air Flow Correction Table	30
Antifreeze Correction Table	31
Blower Performance Data – Standard Unit – PSC	32
Blower Performance Data – High Static – PSC	33
Blower Performance Data (ECM Data)	34
ECM Control	35
Physical Data	37
HB - Horizontal – Dimensional Data	38
HB - Horizontal Service Access	40
HB - Vertical Upflow – Dimensional Data	41
HB - Vertical Service Access	43
Corner Weights for HBH Series Units	44
Electrical Data – Standard Unit	45
Electrical Data – High Static Blower	46
Electrical Data – ECM	47
HB Series Wiring Diagram Matrix	48
Typical Wiring Diagram – Single Phase HB Units with CXM Controller	49
Typical Wiring Diagram – Single Phase HB Units with CXM Controller, ECM Blower	50
Typical Wiring Diagram – Three Phase 208/230V HB Units with CXM Controller	51
Typical Wiring Diagram – Three Phase 208/230V HB Units with DXM Controller	52
Typical Wiring Diagram – Three Phase 460/575V HB Units with CXM Controller	53
Typical Wiring Diagram – Three Phase 460/575V HB Units with DXM Controller	54
Typical Wiring Diagram – Three Phase 460/575V HB Units with CXM And LON Controller	55
Typical Wiring Diagram – Three Phase 460/575V HB Units with DXM & LON Controller	56
Typical Wiring Diagram – Three Phase 460/575V HB Units with CXM & MPC Controller	57
Typical Wiring Diagram – Three Phase 460/575V HB Units with DXM & MPC Controller	58
Engineering Specifications	59
Revision History	66

COMPACT (HB) SERIES

The award winning HB Series raises the bar for water-source heat pump efficiencies, features and application flexibility. Not only does the HB Series exceed ASHRAE 90.1 efficiencies, but it also uses EarthPure® HFC-410A zero ozone depletion refrigerant, making it an extremely environmentally-friendly option. The HB Series is eligible for additional LEED® (Leadership in Energy and Environmental Design) points because of the “green” technology design. With one of the smallest cabinets in the industry, the HB Series will easily fit into tight spaces. Designed to be backward compatible with thousands of older water-source heat pumps, the HB Series heat pump is packed full of the innovation you have come to expect from the experts at MARS.

Available in sizes from 1/2 ton (1.76 kW) through 5 tons (17.6 kW) with multiple cabinet options (vertical upflow and horizontal) the HB Series offers a wide range of units for most anaxy powder painted front access panel, galvanized steel with epoxy powder painted drain pan and sound absorbing air handler insulation are just some of the features of the HB Series.

MARS's exclusive double isolation compressor mounting system makes the HB Series the quietest unit on the market. Compressors are mounted on specially engineered sound-tested EPDM grommets or spring vibration isolators to a heavy gauge mounting plate, which is further isolated from the cabinet base with rubber grommets for maximized vibration/sound attenuation. The easy access control box and large access panels make installing and maintaining the unit easier than other water-source heat pumps currently in production, proving that a small unit can be easy to service.

Options such as coated air coil, DDC controls, high efficiency pleated MERV 11 two-inch (51mm) air filter or one-inch (25mm) pleated MERV 8 air filters allow customized design solutions. Optional high static fan motor expands the operating range and helps overcome some of the challenges associated with ductwork for retrofit installations. A cupro-nickel water-coil and sound absorbing mute package are options that make a great unit even better.

The HB Series Water-Source Heat Pumps are designed to meet the challenges of today's HVAC demands with one of the most innovative products available on the market.

UNIT FEATURES

Sizes 006 (1/2 ton, 1.76 kW) through 060 (5 tons, 17.6 kW)
 EarthPure® HFC-410A refrigerant
 Exceeds ASHRAE 90.1 efficiencies
 Galvanized steel construction with attractive matte black epoxy powder coat paint front access panel
 Epoxy powder painted galvanized steel drain pan
 Sound absorbing glass fiber insulation
 Unique double isolation compressor mounting via vibration isolating rubber grommets for quiet operation
 Insulated divider and separate compressor/air handler compartments
 Copeland scroll compressors (rotary for size 018 and below)
 TXV metering device
 Microprocessor controls standard (optional DXM and/or DDC controls)
 Field convertible discharge air arrangement for horizontal units
 PSC three-speed fan motor
 Internally trapped condensate drain line (vertical units only)
 Unit Performance Sentinel performance monitoring system
 Eight Safeties Standard
 Extended range (20 to 120°F, -6.7 to 48.9°C) capable

AVAILABLE OPTIONS

- High static blowers
- LonWorks, BACnet, Modbus and Johnson N2 compatibility options for DDC controls
- Cupro-nickel water-coil
- Sound absorbing UltraQuiet package
- ECM Blowers

Selection Procedure

Reference Calculations

Heating	Cooling	
$LWT = EWT - \frac{HE}{GPM \times 500}$	$LWT = EWT + \frac{HR}{GPM \times 500}$	$LC = TC - SC$
$LAT = EAT + \frac{HC}{CFM \times 1.08}$	$LAT (DB) = EAT (DB) - \frac{SC}{CFM \times 1.08}$	$S/T = \frac{SC}{TC}$

Legend and Glossary of Abbreviations

BTUH = BTU(British Thermal Unit) per hour	HWC = hot water generator (desuperheater) capacity, Mbtuh
CFM = airflow, cubic feet/minute	FPT = female pipe thread
COP = coefficient of performance = BTUH output/BTUH input	KW = total power unit input, kilowatts
DB = dry bulb temperature (°F)	LAT = leaving air temperature, °F
EAT = entering air temperature, Fahrenheit (dry bulb/wet bulb)	LC = latent cooling capacity, BTUH
EER = energy efficiency ratio = BTUH output/Watt input	LWT = leaving water temperature, °F
MPT = male pipe thread	MBTUH = 1000 BTU per hour
ESP = external static pressure (inches w.g.)	S/T = sensible to total cooling ratio
EWT = entering water temperature	SC = sensible cooling capacity, BTUH
GPM = water flow in U.S. gallons/minute	TC = total cooling capacity, BTUH
HE = total heat of extraction, BTUH	WB = wet bulb temperature (°F)
HC = air heating capacity, BTUH	WPD = waterside pressure drop (psi & ft. of hd.)
HR = total heat of rejection, BTUH	

Conversion Table - to convert inch-pound (English) to S-I (Metric)

Air Flow	Water Flow	Ext Static Pressure	Water Pressure Drop
Airflow (L/s) = CFM x 0.472	Water Flow (L/s) = gpm x 0.0631	ESP (Pa) = ESP (in of wg) x 249	PD (kPa) = PD (ft of hd) x 2.99

Selection Procedure

- Step 1 Determine the actual heating and cooling loads at the desired dry bulb and wet bulb conditions.
- Step 2 Obtain the following design parameters: Entering water temperature, water flow rate in GPM, air flow in CFM, water flow pressure drop and design wet and dry bulb temperatures. Air flow CFM should be between 300 and 450 CFM per ton. Unit water pressure drop should be kept as close as possible to each other to make water balancing easier. Go to the appropriate tables and find the proper indicated water flow and water temperature.
- Step 3 Select a unit based on total and sensible cooling conditions. Select a unit which is closest to, but no larger than, the actual cooling load.
- Step 4 Enter tables at the design water flow and water temperature. Read the total and sensible cooling capacities (Note: interpolation is permissible, extrapolation is not).
- Step 5 Read the heating capacity. If it exceeds the design criteria it is acceptable. It is quite normal for Water-Source Heat Pumps to be selected on cooling capacity only since the heating output is usually greater than the cooling capacity.
- Step 6 Determine the correction factors associated with the variable factors of dry bulb, wet bulb and air flow.

 Corrected Total Cooling = tabulated total cooling x wet bulb correction x air flow correction

 Corrected Sensible Cooling = tabulated sensible cooling x dry bulb correction x air flow correction
- Step 7 Compare the corrected capacities to the load requirements. Normally if the capacities are within 10% of the loads, the equipment is acceptable. It is better to undersize than oversize, as undersizing improves humidity control, reduces sound levels and extends the life of the equipment.
- Step 8 When completed, calculate water temperature rise and assess the selection. If the units selected are not within 10% of the load calculations, then review what effect changing the GPM, water temperature and/or air flow and air temperature would have on the corrected capacities. If the desired capacity cannot be achieved, select the next larger or smaller unit and repeat the procedure. Remember, when in doubt, undersize slightly for best performance.

Example Equipment Selection For Cooling

Step 1 Load Determination:

Assume we have determined that the appropriate cooling load at the desired dry bulb 80°F and wet bulb 65°F conditions is as follows:

Total Cooling.....23,700 BTUH
 Sensible Cooling.....16,500 BTUH
 Entering Air Temp.....80°F Dry Bulb / 65°F Wet Bulb

Step 2 Design Conditions:

Similarly, we have also obtained the following design parameters:

Entering Water Temp.....90°F
 Water Flow (Based upon 10°F rise in temp.).....6.0 GPM
 Air Flow.....800 CFM

Step 3, 4 & 5 HP Selection:

After making our preliminary selection (TC024), we enter the tables at design water flow and water temperature and read Total Cooling, Sens. Cooling and Heat of Rej. capacities:

Total Cooling.....23,400 BTUH
 Sensible Cooling.....17,500 BTUH
 Heat of Rejection.....30,200 BTUH

Step 6 & 7 Entering Air and Airflow Corrections:

Next, we determine our correction factors.

Table	Ent Air	Air Flow	Corrected
Corrected Total Cooling = 23,400 x 0.9681 x 1.0050 = 22,767			
Corrected Sens Cooling = 17,500 x 1.1213 x 0.9820 = 19,270			
Corrected Heat of Rej. = 30,200 x 0.9747 x 1.0434 = 30,713			

Step 8 Water Temperature Rise Calculation & Assessment:

Actual Temperature Rise.....10.2°F

When we compare the Corrected Total Cooling and Corrected Sensible Cooling figures with our load requirements stated in Step 1, we discover that our selection is within +/- 10% of our sensible load requirement. Furthermore, we see that our Corrected Total Cooling figure is within 1,000 Btuh the actual indicated load.

HB Series Nomenclature

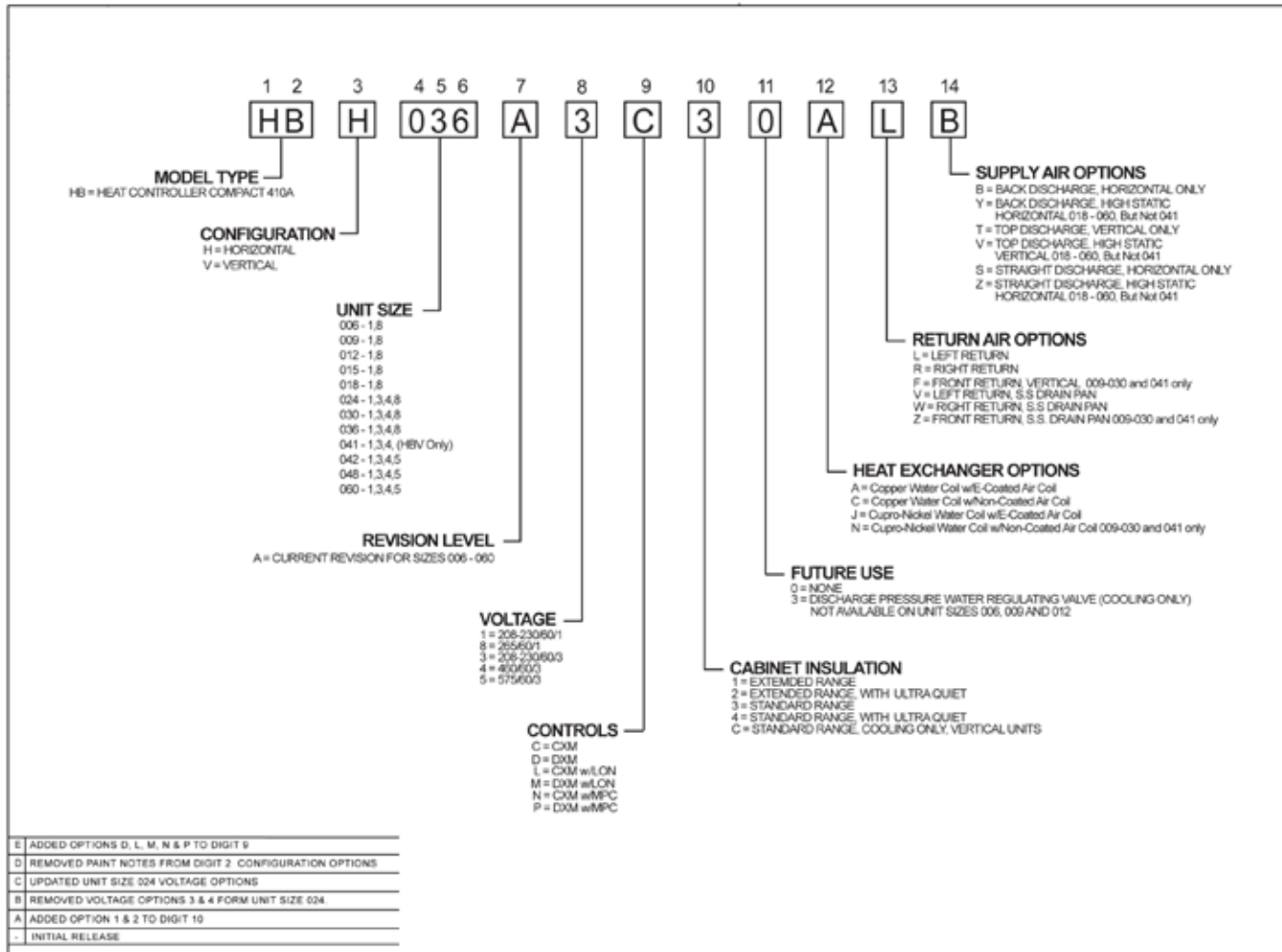

Performance Data – AHRI/ASHRAE/ISO 13256-1

ASHRAE/AHRI/ISO 13256-1. English (I-P) Units

Model	Fan Motor	Water Loop Heat Pump				Ground Water Heat Pump				Ground Loop Heat Pump			
		Cooling 86°F		Heating 68°F		Cooling 59°F		Heating 50°F		Cooling 77°F		Heating 32°F	
		Capacity Btuh	EER Btuh/W	Capacity Btuh	COP	Capacity Btuh	EER Btuh/W	Capacity Btuh	COP	Capacity Btuh	EER Btuh/W	Capacity Btuh	COP
HB-006	PSC	5,800	13.2	7,500	4.7	6,900	21.1	6,200	4.0	6,200	15.4	4,900	3.4
HB-009	PSC	8,800	13.4	11,600	4.2	10,100	21.0	9,800	3.9	9,300	15.7	7,900	3.4
HB-012	PSC	11,700	13.5	15,200	4.3	13,700	20.8	12,500	3.8	12,000	14.9	9,900	3.2
HB-015	PSC	14,500	15.4	17,300	5.0	16,800	24.5	14,400	4.4	15,000	17.2	11,100	3.6
	ECM	14,500	15.5	16,800	5.1	16,800	25.0	13,800	4.4	15,000	17.9	10,900	3.6
HB-018	PSC	17,300	14.3	21,500	5.0	20,600	24.2	17,200	4.4	18,400	16.3	13,900	3.4
	ECM	19,600	15.9	22,000	5.3	22,300	24.8	18,200	4.6	20,200	18.1	14,100	3.8
HB-024	PSC	23,700	13.4	28,500	4.7	26,700	20.9	24,000	4.1	24,900	15.4	18,500	3.3
	ECM	23,800	14.3	27,700	4.9	26,700	21.5	23,400	4.1	24,900	16.4	18,500	3.5
HB-030	PSC	28,100	13.4	35,100	4.6	31,700	20.1	29,600	4.1	28,900	15.1	23,400	3.4
	ECM	28,300	14.3	35,800	4.8	32,400	22.0	30,000	4.4	29,300	16.5	23,600	3.7
HB-036	PSC	34,500	13.5	45,200	4.4	38,700	20.7	37,500	4.0	35,300	14.9	29,600	3.3
	ECM	34,500	14.0	43,400	4.5	39,000	20.9	35,800	4.0	35,400	15.5	28,700	3.4
HBV-041	PSC	36,500	13.2	45,700	4.2	41,400	19.7	38,000	3.7	38,000	14.8	30,100	3.1
HB-042	PSC	40,100	13.2	52,700	4.3	45,900	19.6	44,000	3.8	40,500	14.4	34,300	3.2
	ECM	42,100	14.9	50,400	4.5	46,400	22.0	42,400	4.0	42,200	16.8	33,900	3.4
HB-048	PSC	47,700	13.3	55,900	4.7	54,300	20.5	46,500	4.1	49,000	14.7	36,400	3.4
	ECM	47,900	14.2	53,000	4.8	53,600	21.0	45,600	4.3	49,000	16.2	36,400	3.6
HB-060	PSC	59,400	13.4	72,000	4.3	66,600	19.9	60,000	3.9	60,100	14.8	47,500	3.3
	ECM	60,000	14.8	71,200	4.4	67,000	21.0	59,600	4.0	61,400	16.5	47,500	3.4

Cooling capacities based upon 80.6°F DB, 66.2°F WB entering air temperature
 Heating capacities based upon 68°F DB, 59°F WB entering air temperature
 All ratings based upon operation at lower voltage of dual voltage rated models

ASHRAE/AHRI/ISO 13256-1. Metric (S-I) Units

Model	Fan Motor	Water Loop Heat Pump				Ground Water Heat Pump				Ground Loop Heat Pump			
		Cooling 86°F		Heating 68°F		Cooling 59°F		Heating 50°F		Full Cooling 77°F		Full Heating 32°F	
		Capacity Btuh	EER W/W	Capacity Btuh	COP	Capacity Btuh	EER W/W	Capacity Btuh	COP	Capacity Btuh	EER W/W	Capacity Btuh	COP
HB-006	PSC	1.70	3.9	2.20	4.7	2.02	6.2	1.82	4.0	1.82	4.5	1.44	3.4
HB-009	PSC	2.58	3.9	3.40	4.2	2.96	6.2	2.87	3.9	2.72	4.6	2.31	3.4
HB-012	PSC	3.43	4.0	4.45	4.3	4.01	6.1	3.66	3.8	3.52	4.4	2.90	3.2
HB-015	PSC	4.25	4.5	5.07	5.0	4.92	7.2	4.22	4.4	4.39	5.0	3.25	3.6
	ECM	4.25	4.5	4.92	5.1	4.92	7.3	4.04	4.4	4.39	5.2	3.19	3.6
HB-018	PSC	5.07	4.2	6.30	5.0	6.04	7.1	5.04	4.4	5.39	4.8	4.07	3.4
	ECM	5.74	4.7	6.45	5.3	6.54	7.3	5.33	4.6	5.92	5.3	4.13	3.8
HB-024	PSC	6.94	3.9	8.35	4.7	7.82	6.1	7.03	4.1	7.30	4.5	5.42	3.3
	ECM	6.97	4.2	8.12	4.9	7.82	6.3	6.87	4.1	7.30	4.8	5.42	3.5
HB-030	PSC	8.23	3.9	10.28	4.6	9.29	5.9	8.67	4.1	8.47	4.4	6.86	3.4
	ECM	8.29	4.2	10.49	4.8	9.49	6.4	8.79	4.4	8.58	4.8	6.91	3.7
HB-036	PSC	10.11	4.0	13.24	4.4	11.34	6.1	10.99	4.0	10.34	4.4	8.67	3.3
	ECM	10.11	4.1	12.72	4.5	11.43	6.1	10.49	4.0	10.37	4.5	8.41	3.4
HBV041	PSC	10.69	3.9	13.39	4.2	12.13	5.8	11.13	3.7	11.13	4.3	8.82	3.1
HB-042	PSC	11.75	3.9	15.44	4.3	13.45	5.7	12.89	3.8	11.87	4.2	10.05	3.2
	ECM	12.34	4.4	14.77	4.5	13.60	6.4	12.42	4.0	12.36	4.9	9.93	3.4
HB-048	PSC	13.98	3.9	16.38	4.7	15.91	6.0	13.62	4.1	14.36	4.3	10.67	3.4
	ECM	14.03	4.2	15.53	4.8	15.70	6.2	13.36	4.3	14.36	4.7	10.67	3.6
HB-060	PSC	17.40	3.9	21.10	4.3	19.51	5.8	17.58	3.9	17.61	4.3	14.80	3.3
	ECM	17.58	4.3	20.86	4.4	19.63	6.2	17.46	4.0	17.99	4.8	13.92	3.4

Cooling capacities based upon 27°C DB, 19°C WB entering air temperature
 Heating capacities based upon 20°C DB, 15°C WB entering air temperature
 All ratings based upon operation at lower voltage of dual voltage rated models

Performance Data – Selection Notes

For operation in the shaded area when water is used in lieu of an antifreeze solution, the LWT (Leaving Water Temperature) must be calculated. Flow must be maintained to a level such that the LWT is maintained above 40°F [4.4°C] when the JW3 jumper is not clipped (see example below). Otherwise, appropriate levels of a proper antifreeze solution should be used in systems with leaving water temperatures of 40°F or below and the JW3 jumper should be clipped. This is due to the potential of the refrigerant temperature being as low as 32°F [0°C] with 40°F [4.4°C] LWT, which may lead to a nuisance cutout due to the activation of the Low Temperature Protection. JW3 should never be clipped for standard range equipment or systems without antifreeze.

Example:

At 50°F EWT (Entering Water Temperature) and 2.25 gpm/ton, a 3 ton unit has a HE of 27,300 Btuh. To calculate LWT, rearrange the formula for HE as follows:

HE = TD x GPM x 500, where HE = Heat of Extraction (Btuh);
 TD = temperature difference (EWT - LWT) and GPM = U.S. Gallons per Minute.

$$TD = HE / (GPM \times 500)$$

$$TD = 27,300 / (6.75 \times 500)$$

$$TD = 8^\circ\text{F}$$

$$\text{LWT} = \text{EWT} - \text{TD}$$

$$\text{LWT} = 50 - 8 = 42^\circ\text{F}$$

In this example, as long as the EWT does not fall below 50°F, the system will operate as designed. For EWTs below 50°F, higher flow rates will be required (open loop systems, for example, require at least 2 gpm/ton when EWT is below 50°F).

Heating - EAT 70°F						
	Airflow CFM	HC	kW	HE	LAT	COP
	860	22.6	2.67	14.1	94	2.49
	1150	23.2	2.39	15.1	89	2.84
23.8	860	25.6	2.80	16.6	98	2.68
23.8	1150	26.2	2.51	17.7	91	3.06
24.7	860	26.8	2.85	17.6	99	2.76
24.7	1150	27.5	2.56	18.8	92	3.15
25.0	860	27.5	2.88	18.2	100	2.80
25.0	1150	28.2	2.59	19.4	93	3.19
21.8	860	30.1	2.98	20.3	102	2.95
21.8	1150	30.8	2.68	21.7	95	3.37
23.3	860	31.6	3.05	21.6	104	3.04
23.3	1150	32.4	2.74	23.1	96	3.47
23.9	860	32.4	3.08	22.3	105	3.09
23.9	1150	33.2	2.77	23.8	97	3.52
19.2	860	34.5	3.16	24.1	107	3.20
19.2	1150	35.4	2.84	25.7	98	3.65
21.0	860	36.3	3.23	25.6	109	3.30
21.0	1150	37.2	2.90	27.3	100	3.76
21.9	860	37.3	3.27	26.4	110	3.35
21.9	1150	38.2	2.93	28.2	101	3.82
16.4	860	38.9	3.32	27.8	112	3.43
16.4	1150	39.8	2.99	29.7	102	3.91
16.4	860	40.9	3.40	29.5	114	3.53
16.4	1150	41.9	3.05	31.5	104	4.02
16.4	860	42.0	3.44	30.4	115	3.62
16.4	1150	43.0	3.09	32.5	105	4.11
16.4	860	43.1	3.47	31.4	116	3.67
16.4	1150	44.1	3.12	33.5	106	4.20

Performance Data – HB H/V 006 (PSC Blower)

220 CFM Nominal (Rated) Airflow

Performance capacities shown in thousands of Btuh

EWT °F	GPM	WPD		Cooling - EAT 80/67°F							Heating - EAT 70°F					
		PSI	FT	Airflow CFM	TC	SC	Sens/Tot Ratio	kW	HR	EER	Airflow CFM	HC	kW	HE	LAT	COP
20	1.5	1.7	4.0	Operation not recommended							170	4.3	0.49	2.7	93.3	2.6
	1.5	1.7	4.0	Operation not recommended							225	4.4	0.44	2.9	88.0	2.9
30	0.8	0.5	1.2	170	7.4	4.2	0.57	0.28	8.4	26.4	170	4.6	0.50	3.0	95.2	2.7
	0.8	0.5	1.2	225	7.7	4.8	0.62	0.29	8.7	26.4	225	4.7	0.45	3.2	89.5	3.1
	1.1	0.8	1.8	170	7.4	4.1	0.55	0.26	8.3	28.5	170	4.8	0.51	3.2	96.2	2.8
	1.1	0.8	1.8	225	7.7	4.6	0.60	0.27	8.6	28.5	225	4.9	0.46	3.4	90.3	3.2
	1.5	1.3	2.9	170	7.3	4.0	0.54	0.25	8.2	29.2	170	4.9	0.51	3.2	96.8	2.8
	1.5	1.3	2.9	225	7.6	4.5	0.59	0.26	8.5	29.2	225	5.0	0.46	3.5	90.7	3.2
40	0.8	0.4	0.9	170	7.3	4.3	0.59	0.31	8.3	23.2	170	5.3	0.52	3.6	98.8	3.0
	0.8	0.4	0.9	225	7.6	4.8	0.64	0.33	8.7	23.2	225	5.4	0.47	3.8	92.3	3.4
	1.1	0.6	1.4	170	7.4	4.2	0.57	0.29	8.4	25.8	170	5.5	0.53	3.8	100.2	3.1
	1.1	0.6	1.4	225	7.7	4.8	0.62	0.30	8.7	25.8	225	5.7	0.47	4.1	93.3	3.5
	1.5	1.0	2.4	170	7.4	4.2	0.56	0.28	8.4	26.9	170	5.7	0.53	3.9	100.9	3.1
	1.5	1.0	2.4	225	7.7	4.7	0.61	0.29	8.7	26.9	225	5.8	0.48	4.2	93.9	3.6
50	0.8	0.3	0.8	170	6.9	4.2	0.61	0.35	8.1	19.9	170	6.0	0.54	4.2	102.7	3.3
	0.8	0.3	0.8	225	7.2	4.8	0.66	0.36	8.5	19.9	225	6.1	0.48	4.5	95.3	3.7
	1.1	0.5	1.2	170	7.2	4.3	0.59	0.32	8.3	22.5	170	6.3	0.55	4.5	104.4	3.4
	1.1	0.5	1.2	225	7.5	4.8	0.64	0.33	8.6	22.5	225	6.5	0.49	4.8	96.6	3.9
	1.5	0.9	2.0	170	7.3	4.3	0.58	0.31	8.3	23.8	170	6.5	0.55	4.6	105.4	3.4
	1.5	0.9	2.0	225	7.6	4.8	0.63	0.32	8.7	23.8	225	6.7	0.50	5.0	97.4	3.9
60	0.8	0.3	0.6	170	6.5	4.1	0.63	0.39	7.9	16.8	170	6.7	0.56	4.9	106.7	3.5
	0.8	0.3	0.6	225	6.8	4.7	0.69	0.40	8.2	16.8	225	6.9	0.50	5.2	98.4	4.0
	1.1	0.5	1.0	170	6.9	4.2	0.61	0.36	8.1	19.1	170	7.1	0.57	5.2	108.6	3.7
	1.1	0.5	1.0	225	7.1	4.8	0.67	0.37	8.4	19.1	225	7.3	0.51	5.5	99.9	4.2
	1.5	0.8	1.8	170	7.0	4.2	0.61	0.34	8.2	20.4	170	7.3	0.57	5.3	109.7	3.7
	1.5	0.8	1.8	225	7.3	4.8	0.66	0.36	8.5	20.4	225	7.5	0.51	5.7	100.7	4.3
70	0.8	0.2	0.5	170	6.0	4.0	0.66	0.43	7.5	14.0	170	7.4	0.58	5.5	110.5	3.8
	0.8	0.2	0.5	225	6.3	4.5	0.72	0.45	7.8	14.0	225	7.6	0.52	5.9	101.4	4.3
	1.1	0.4	0.9	170	6.4	4.1	0.64	0.40	7.8	16.0	170	7.8	0.58	5.8	112.4	3.9
	1.1	0.4	0.9	225	6.7	4.6	0.70	0.42	8.1	16.0	225	8.0	0.53	6.2	102.8	4.5
	1.5	0.7	1.6	170	6.6	4.1	0.63	0.38	7.9	17.1	170	8.0	0.59	5.9	113.4	4.0
	1.5	0.7	1.6	225	6.8	4.7	0.69	0.40	8.2	17.1	225	8.2	0.53	6.4	103.6	4.5
80	0.8	0.2	0.5	170	5.6	3.8	0.68	0.47	7.2	12.0	170	7.9	0.59	5.9	113.2	4.0
	0.8	0.2	0.5	225	5.8	4.3	0.74	0.49	7.5	12.0	225	8.1	0.53	6.3	103.5	4.5
	1.1	0.4	0.8	170	5.9	3.9	0.67	0.45	7.4	13.2	170	8.3	0.60	6.3	115.4	4.1
	1.1	0.4	0.8	225	6.1	4.4	0.73	0.46	7.7	13.2	225	8.5	0.54	6.7	105.1	4.6
	1.5	0.6	1.5	170	6.2	4.0	0.65	0.42	7.6	14.7	170	8.4	0.60	6.3	115.7	4.1
	1.5	0.6	1.5	225	6.4	4.6	0.71	0.44	7.9	14.7	225	8.6	0.54	6.7	105.3	4.6
85	0.8	0.2	0.5	170	5.3	3.7	0.70	0.50	7.0	10.7	170	8.2	0.60	6.2	114.7	4.0
	0.8	0.2	0.5	225	5.5	4.2	0.76	0.52	7.3	10.7	225	8.4	0.50	6.6	104.6	4.6
	1.1	0.3	0.8	170	5.6	3.8	0.68	0.47	7.2	11.9	170	8.5	0.60	6.4	116.2	4.1
	1.1	0.3	0.8	225	5.8	4.3	0.74	0.49	7.5	11.9	225	8.7	0.50	6.8	105.8	4.7
	1.5	0.6	1.4	170	5.8	3.9	0.67	0.45	7.4	13.1	170	8.5	0.60	6.4	116.4	4.1
	1.5	0.6	1.4	225	6.1	4.4	0.73	0.47	7.7	13.1	225	8.7	0.50	6.8	105.9	4.7
90	0.8	0.2	0.4	170	5.0	3.6	0.72	0.53	6.7	9.4	170	8.5	0.61	6.4	116.3	4.1
	0.8	0.2	0.4	225	5.2	4.1	0.79	0.55	7.0	9.4	225	8.7	0.55	6.8	105.8	4.7
	1.1	0.3	0.7	170	5.3	3.7	0.70	0.49	7.0	10.7	170	8.6	0.62	6.5	117.0	4.1
	1.1	0.3	0.7	225	5.5	4.2	0.76	0.52	7.3	10.7	225	8.8	0.55	7.0	106.4	4.7
	1.5	0.6	1.3	170	5.5	3.8	0.69	0.48	7.1	11.5	170	8.7	0.62	6.5	117.1	4.1
	1.5	0.6	1.3	225	5.7	4.3	0.75	0.50	7.4	11.5	225	8.9	0.56	7.0	106.5	4.7
100	0.8	0.2	0.4	170	4.4	3.4	0.76	0.58	6.4	7.6	Operation not recommended					
	0.8	0.2	0.4	225	4.6	3.8	0.83	0.60	6.6	7.6						
	1.1	0.3	0.7	170	4.7	3.5	0.74	0.55	6.6	8.7						
	1.1	0.3	0.7	225	4.9	4.0	0.80	0.57	6.9	8.7						
	1.5	0.5	1.2	170	4.9	3.6	0.73	0.53	6.7	9.3						
	1.5	0.5	1.2	225	5.1	4.0	0.79	0.55	7.0	9.3						
110	0.8	0.2	0.3	170	3.9	3.1	0.81	0.63	6.0	6.2	Operation not recommended					
	0.8	0.2	0.3	225	4.1	3.6	0.87	0.66	6.3	6.2						
	1.1	0.3	0.6	170	4.2	3.3	0.78	0.60	6.2	7.0						
	1.1	0.3	0.6	225	4.4	3.7	0.85	0.62	6.5	7.0						
	1.5	0.5	1.2	170	4.3	3.3	0.77	0.58	6.3	7.4						
	1.5	0.5	1.2	225	4.5	3.8	0.83	0.61	6.6	7.4						
120	0.8	0.1	0.3	170	3.5	3.0	0.85	0.68	5.8	5.0	Operation not recommended					
	0.8	0.1	0.3	225	3.6	3.3	0.93	0.71	6.0	5.0						
	1.1	0.3	0.6	170	3.7	3.0	0.83	0.65	5.9	5.6						
	1.1	0.3	0.6	225	3.8	3.4	0.90	0.68	6.2	5.6						
	1.5	0.5	1.1	170	3.8	3.1	0.81	0.64	6.0	6.0						
	1.5	0.5	1.1	225	4.0	3.5	0.88	0.67	6.2	6.0						

Interpolation is permissible; extrapolation is not.
 All entering air conditions are 80°F DB and 67°F WB in cooling, and 70°F DB in heating.
 AHRI/ISO certified conditions are 80.6°F DB and 66.2°F WB in cooling and 68°F DB in heating.
 Table does not reflect fan or pump power corrections for AHRI/ISO conditions.
 All performance is based upon the lower voltage of dual voltage rated units.
 Performance stated is at the rated power supply; performance may vary as the power supply varies from the rated.
 Operation below 40°F EWT is based upon a 15% methanol antifreeze solution.
 Operation below 60°F EWT requires optional insulated water/refrigerant circuit.
 See performance correction tables for operating conditions other than those listed above.
 See Performance Data Selection Notes for operation in the shaded areas.

Performance Data – HBH/V 009 (PSC Blower)

325 CFM Nominal (Rated) Airflow

Performance capacities shown in thousands of Btuh

EWT °F	GPM	WPD		Cooling - EAT 80/67°F							Heating - EAT 70°F					
		PSI	FT	Airflow CFM	TC	SC	Sens/Tot Ratio	kW	HR	EER	Airflow CFM	HC	kW	HE	LAT	COP
20	2.3	4.5	10.5	Operation not recommended							250	6.5	0.73	4.2	94.2	2.6
	2.3	4.5	10.5								330	6.7	0.66	4.4	88.8	3.0
30	1.1	1.3	3.0	250	10.2	6.0	0.59	0.39	11.6	26.6	250	7.1	0.74	4.7	96.3	2.8
	1.1	1.3	3.0	330	10.7	6.8	0.64	0.40	12.0	26.6	330	7.3	0.67	5.0	90.4	3.2
	1.7	1.9	4.4	250	10.5	6.0	0.57	0.36	11.7	29.5	250	7.4	0.75	4.9	97.4	2.9
	1.7	1.9	4.4	330	10.9	6.8	0.62	0.37	12.2	29.5	330	7.6	0.67	5.3	91.2	3.3
	2.3	3.5	8.1	250	10.6	6.0	0.56	0.34	11.8	31.1	250	7.5	0.75	5.1	97.9	2.9
	2.3	3.5	8.1	330	11.0	6.8	0.61	0.36	12.3	31.1	330	7.7	0.68	5.4	91.7	3.4
40	1.1	0.9	2.0	250	9.9	6.0	0.61	0.43	11.3	22.8	250	8.0	0.76	5.5	99.8	3.1
	1.1	0.9	2.0	330	10.3	6.8	0.66	0.45	11.8	22.8	330	8.2	0.69	5.9	93.1	3.5
	1.7	1.5	3.5	250	10.1	6.0	0.59	0.40	11.5	25.4	250	8.4	0.77	5.8	101.1	3.2
	1.7	1.5	3.5	330	10.5	6.8	0.64	0.41	12.0	25.4	330	8.6	0.69	6.2	94.1	3.6
	2.3	3.0	6.8	250	10.3	6.0	0.59	0.38	11.6	26.8	250	8.6	0.78	6.0	101.8	3.2
	2.3	3.0	6.8	330	10.7	6.8	0.64	0.40	12.0	26.9	330	8.8	0.70	6.4	94.7	3.7
50	1.1	0.6	1.5	250	9.4	6.0	0.63	0.48	11.1	19.5	250	9.0	0.79	6.4	103.3	3.4
	1.1	0.6	1.5	330	9.8	6.7	0.69	0.50	11.6	19.5	330	9.2	0.71	6.8	95.8	3.8
	1.7	1.3	2.9	250	9.7	6.0	0.62	0.45	11.3	21.7	250	9.4	0.80	6.7	104.8	3.5
	1.7	1.3	2.9	330	10.1	6.8	0.67	0.47	11.7	21.7	330	9.6	0.72	7.2	97.0	3.9
	2.3	2.6	6.0	250	9.9	6.0	0.61	0.43	11.3	23.0	250	9.6	0.80	6.9	105.6	3.5
	2.3	2.6	6.0	330	10.3	6.8	0.66	0.45	11.8	23.0	330	9.8	0.72	7.4	97.6	4.0
60	1.1	0.5	1.2	250	9.0	5.9	0.65	0.54	10.8	16.5	250	9.9	0.81	7.2	106.8	3.6
	1.1	0.5	1.2	330	9.4	6.7	0.71	0.57	11.3	16.5	330	10.2	0.73	7.7	98.5	4.1
	1.7	1.1	2.5	250	9.3	5.9	0.64	0.50	11.0	18.5	250	10.4	0.82	7.6	108.4	3.7
	1.7	1.1	2.5	330	9.7	6.7	0.69	0.52	11.5	18.5	330	10.6	0.74	8.1	99.8	4.2
	2.3	2.3	5.4	250	9.5	6.0	0.63	0.48	11.1	19.6	250	10.6	0.83	7.8	109.3	3.7
	2.3	2.3	5.4	330	9.8	6.7	0.69	0.50	11.6	19.6	330	10.9	0.75	8.3	100.5	4.3
70	1.1	0.4	0.9	250	8.5	5.8	0.68	0.61	10.6	14.0	250	10.8	0.84	8.0	110.1	3.8
	1.1	0.4	0.9	330	8.8	6.5	0.74	0.63	11.0	14.0	330	11.1	0.75	8.5	101.1	4.3
	1.7	1.0	2.3	250	8.8	5.8	0.66	0.56	10.7	15.6	250	11.3	0.85	8.4	111.9	3.9
	1.7	1.0	2.3	330	9.2	6.6	0.72	0.59	11.2	15.6	330	11.6	0.77	9.0	102.5	4.4
	2.3	2.1	4.9	250	9.1	5.9	0.65	0.53	10.9	17.1	250	11.4	0.85	8.5	112.1	3.9
	2.3	2.1	4.9	330	9.5	6.7	0.71	0.55	11.3	17.1	330	11.6	0.77	9.0	102.7	4.4
80	1.1	0.3	0.8	250	8.0	5.6	0.70	0.67	10.3	11.8	250	11.7	0.87	8.7	113.3	4.0
	1.1	0.3	0.8	330	8.3	6.3	0.77	0.70	10.7	11.8	330	12.0	0.78	9.3	103.6	4.5
	1.7	0.9	2.1	250	8.3	5.7	0.69	0.63	10.5	13.2	250	12.2	0.88	9.1	115.1	4.0
	1.7	0.9	2.1	330	8.6	6.5	0.75	0.66	10.9	13.2	330	12.5	0.79	9.8	105.0	4.6
	2.3	2.0	4.6	250	8.6	5.8	0.67	0.59	10.6	14.4	250	12.2	0.88	9.2	115.4	4.1
	2.3	2.0	4.6	330	8.9	6.5	0.73	0.62	11.1	14.4	330	12.5	0.79	9.8	105.2	4.6
85	1.1	0.3	0.7	250	7.7	5.5	0.71	0.70	10.1	11.0	250	12.0	0.88	9.0	114.5	4.0
	1.1	0.3	0.7	330	8.0	6.2	0.78	0.73	10.5	11.0	330	12.3	0.80	9.6	104.6	4.6
	1.7	0.9	2.0	250	8.0	5.6	0.70	0.67	10.3	12.1	250	12.6	0.90	9.5	116.5	4.1
	1.7	0.9	2.0	330	8.4	6.4	0.76	0.69	10.7	12.1	330	12.9	0.80	10.1	106.1	4.7
	2.3	1.9	4.4	250	8.3	5.7	0.69	0.63	10.5	13.3	250	12.6	0.90	9.5	116.8	4.1
	2.3	1.9	4.4	330	8.7	6.5	0.75	0.65	10.9	13.3	330	12.9	0.80	10.2	106.3	4.7
90	1.1	0.3	0.6	250	7.5	5.4	0.72	0.73	10.0	10.2	250	12.3	0.89	9.3	115.7	4.1
	1.1	0.3	0.6	330	7.8	6.2	0.79	0.76	10.4	10.2	330	12.6	0.80	9.9	105.5	4.6
	1.7	0.8	1.9	250	7.7	5.5	0.71	0.70	10.1	11.1	250	12.9	0.91	9.8	117.9	4.2
	1.7	0.8	1.9	330	8.1	6.3	0.78	0.73	10.6	11.1	330	13.3	0.82	10.5	107.2	4.8
	2.3	1.8	4.3	250	8.0	5.6	0.70	0.66	10.3	12.1	250	13.0	0.91	9.9	118.2	4.2
	2.3	1.8	4.3	330	8.4	6.4	0.76	0.69	10.7	12.1	330	13.3	0.82	10.5	107.4	4.8
100	1.1	0.2	0.6	250	6.8	5.1	0.76	0.82	9.6	8.2	Operation not recommended					
	1.1	0.2	0.6	330	7.0	5.8	0.82	0.86	10.0	8.2						
	1.7	0.8	1.7	250	7.1	5.3	0.74	0.78	9.8	9.2						
	1.7	0.8	1.7	330	7.4	6.0	0.81	0.81	10.2	9.2						
	2.3	1.7	4.0	250	7.3	5.4	0.73	0.75	9.9	9.7						
	2.3	1.7	4.0	330	7.6	6.1	0.80	0.78	10.3	9.7						
110	1.1	0.2	0.5	250	6.1	4.8	0.79	0.90	9.2	6.8						
	1.1	0.2	0.5	330	6.3	5.4	0.85	0.94	9.5	6.8						
	1.7	0.7	1.6	250	6.5	5.0	0.77	0.86	9.4	7.6						
	1.7	0.7	1.6	330	6.8	5.6	0.84	0.89	9.8	7.6						
	2.3	1.6	3.8	250	6.7	5.1	0.76	0.83	9.5	8.0						
	2.3	1.6	3.8	330	7.0	5.8	0.83	0.87	9.9	8.0						
120	1.1	0.2	0.4	250	5.4	4.4	0.82	0.98	8.7	5.5						
	1.1	0.2	0.4	330	5.6	5.0	0.89	1.02	9.1	5.5						
	1.7	0.7	1.6	250	5.8	4.6	0.80	0.94	9.0	6.2						
	1.7	0.7	1.6	330	6.0	5.2	0.87	0.98	9.4	6.2						
	2.3	1.6	3.6	250	6.0	4.7	0.79	0.91	9.1	6.5						
	2.3	1.6	3.6	330	6.2	5.4	0.86	0.95	9.5	6.5						

Interpolation is permissible; extrapolation is not.

All entering air conditions are 80°F DB and 67°F WB in cooling, and 70°F DB in heating.

AHRI/ISO certified conditions are 80.6°F DB and 66.2°F WB in cooling and 68°F DB in heating.

Table does not reflect fan or pump power corrections for AHRI/ISO conditions.

All performance is based upon the lower voltage of dual voltage rated units.

Performance stated is at the rated power supply; performance may vary as the power supply varies from the rated.

Operation below 40°F EWT is based upon a 15% methanol antifreeze solution.

Operation below 60°F EWT requires optional insulated water/refrigerant circuit.

See performance correction tables for operating conditions other than those listed above.

See Performance Data Selection Notes for operation in the shaded areas.

Performance Data – HBH/V 012 (PSC Blower)

400 CFM Nominal (Rated) Airflow

Performance capacities shown in thousands of Btuh

EWT °F	GPM	WPD		Cooling - EAT 80/67°F							Heating - EAT 70°F					
		PSI	FT	Airflow CFM	TC	SC	Sens/Tot Ratio	kW	HR	EER	Airflow CFM	HC	kW	HE	LAT	COP
20	3.0	8.5	19.6	Operation not recommended							300	8.5	0.98	5.3	96.2	2.5
	3.0	8.5	19.6								400	8.7	0.88	5.7	90.2	2.9
30	1.5	1.9	4.3	300	14.2	8.2	0.58	0.55	16.1	25.8	300	9.3	1.00	6.0	98.6	2.7
	1.5	1.9	4.3	400	14.8	9.3	0.63	0.57	16.8	25.8	400	9.5	0.90	6.4	91.9	3.1
	2.3	3.6	8.4	300	14.3	8.2	0.58	0.51	16.1	27.9	300	9.6	1.01	6.3	99.7	2.8
	2.3	3.6	8.4	400	14.9	9.3	0.63	0.53	16.7	27.9	400	9.9	0.91	6.8	92.8	3.2
	3.0	6.7	15.5	300	14.3	8.2	0.58	0.50	16.0	28.8	300	9.8	1.02	6.5	100.4	2.8
	3.0	6.7	15.5	400	14.9	9.3	0.63	0.52	16.6	28.8	400	10.1	0.92	7.0	93.3	3.2
40	1.5	1.4	3.2	300	14.0	8.1	0.58	0.61	16.0	22.9	300	10.6	1.04	7.1	102.6	3.0
	1.5	1.4	3.2	400	14.5	9.2	0.63	0.63	16.7	22.9	400	10.8	0.93	7.6	95.0	3.4
	2.3	3.0	6.9	300	14.2	8.2	0.58	0.57	16.1	25.1	300	11.0	1.05	7.6	104.1	3.1
	2.3	3.0	6.9	400	14.8	9.3	0.63	0.59	16.8	25.1	400	11.3	0.94	8.1	96.2	3.5
	3.0	5.7	13.1	300	14.3	8.2	0.58	0.54	16.1	26.2	300	11.3	1.06	7.8	104.9	3.1
	3.0	5.7	13.1	400	14.8	9.3	0.63	0.57	16.8	26.2	400	11.6	0.95	8.3	96.8	3.6
50	1.5	1.1	2.5	300	13.5	7.9	0.58	0.67	15.8	20.1	300	11.9	1.08	8.3	106.8	3.2
	1.5	1.1	2.5	400	14.1	8.9	0.63	0.70	16.5	20.1	400	12.2	0.97	8.9	98.2	3.7
	2.3	2.6	6.0	300	13.9	8.0	0.58	0.62	16.0	22.2	300	12.5	1.09	8.9	108.6	3.4
	2.3	2.6	6.0	400	14.4	9.1	0.63	0.65	16.7	22.2	400	12.8	0.98	9.5	99.6	3.8
	3.0	5.0	11.5	300	14.0	8.1	0.58	0.60	16.1	23.3	300	12.8	1.10	9.1	109.6	3.4
	3.0	5.0	11.5	400	14.6	9.2	0.63	0.63	16.7	23.3	400	13.1	0.99	9.8	100.4	3.9
60	1.5	0.9	2.1	300	12.9	7.6	0.59	0.74	15.5	17.4	300	13.3	1.11	9.6	111.1	3.5
	1.5	0.9	2.1	400	13.5	8.6	0.64	0.77	16.1	17.4	400	13.6	1.00	10.2	101.5	4.0
	2.3	2.3	5.3	300	13.4	7.8	0.58	0.69	15.7	19.3	300	14.0	1.13	10.2	113.1	3.6
	2.3	2.3	5.3	400	13.9	8.8	0.63	0.72	16.4	19.3	400	14.3	1.02	10.8	103.1	4.1
	3.0	4.5	10.3	300	13.6	7.9	0.58	0.67	15.8	20.4	300	14.3	1.14	10.5	114.2	3.7
	3.0	4.5	10.3	400	14.1	8.9	0.63	0.69	16.5	20.4	400	14.7	1.03	11.2	104.0	4.2
70	1.5	0.8	1.8	300	12.2	7.3	0.60	0.82	15.0	14.9	300	14.7	1.15	10.8	115.3	3.7
	1.5	0.8	1.8	400	12.7	8.3	0.65	0.85	15.6	14.9	400	15.0	1.04	11.5	104.8	4.2
	2.3	2.1	4.8	300	12.5	7.4	0.59	0.77	15.2	16.3	300	15.4	1.18	11.4	117.6	3.8
	2.3	2.1	4.8	400	13.1	8.4	0.64	0.80	15.8	16.3	400	15.8	1.06	12.2	106.5	4.4
	3.0	4.1	9.5	300	12.7	7.5	0.59	0.75	15.3	17.0	300	15.8	1.19	11.7	118.8	3.9
	3.0	4.1	9.5	400	13.3	8.5	0.64	0.78	15.9	17.0	400	16.2	1.07	12.5	107.5	4.4
80	1.5	0.7	1.5	300	11.4	7.0	0.61	0.90	14.5	12.7	300	16.0	1.20	11.9	119.4	3.9
	1.5	0.7	1.5	400	11.9	7.9	0.67	0.94	15.1	12.7	400	16.4	1.08	12.7	108.0	4.5
	2.3	1.9	4.4	300	11.8	7.1	0.60	0.85	14.7	13.9	300	16.8	1.22	12.6	121.7	4.0
	2.3	1.9	4.4	400	12.3	8.0	0.65	0.88	15.3	13.9	400	17.2	1.10	13.4	109.8	4.6
	3.0	3.8	8.8	300	12.0	7.2	0.60	0.83	14.8	14.5	300	17.2	1.24	12.9	123.0	4.1
	3.0	3.8	8.8	400	12.5	8.1	0.65	0.86	15.4	14.5	400	17.6	1.11	13.8	110.7	4.6
85	1.5	0.6	1.5	300	10.9	6.8	0.62	0.9	14.2	11.7	300	16.6	1.22	12.5	121.3	4.0
	1.5	0.6	1.5	400	11.4	7.7	0.68	0.98	14.7	11.7	400	17.0	1.1	13.3	109.4	4.6
	2.3	1.8	4.2	300	11.4	6.9	0.61	0.89	14.4	12.8	300	17.4	1.3	13.1	123.6	4.1
	2.3	1.8	4.2	400	11.9	7.9	0.66	0.93	15.0	12.8	400	17.8	1.1	14.0	111.2	4.6
	3.0	3.7	8.5	300	11.6	7.0	0.60	0.87	14.5	13.4	300	17.7	1.3	13.4	124.8	4.1
	3.0	3.7	8.5	400	12.1	7.9	0.66	0.90	15.1	13.4	400	18.2	1.1	14.3	112.1	4.7
90	1.5	0.6	1.4	300	10.5	6.7	0.63	0.99	13.9	10.7	300	17.3	1.24	13.0	123.3	4.1
	1.5	0.6	1.4	400	10.9	7.5	0.69	1.03	14.4	10.7	400	17.7	1.12	13.9	110.9	4.6
	2.3	1.8	4.1	300	11.0	6.8	0.62	0.93	14.1	11.7	300	18.0	1.28	13.6	125.5	4.1
	2.3	1.8	4.1	400	11.4	7.7	0.67	0.97	14.7	11.7	400	18.4	1.15	14.5	112.6	4.7
	3.0	3.6	8.2	300	11.2	6.8	0.61	0.91	14.3	12.3	300	18.3	1.29	13.9	126.6	4.2
	3.0	3.6	8.2	400	11.6	7.7	0.67	0.95	14.8	12.3	400	18.8	1.16	14.8	113.5	4.7
100	1.5	0.5	1.2	300	9.5	6.4	0.67	1.07	13.2	8.9	Operation not recommended					
	1.5	0.5	1.2	400	9.9	7.2	0.72	1.12	13.8	8.9						
	2.3	1.7	3.8	300	10.1	6.5	0.65	1.02	13.5	9.8						
	2.3	1.7	3.8	400	10.5	7.3	0.70	1.06	14.1	9.8						
	3.0	3.3	7.7	300	10.4	6.6	0.64	1.00	13.8	10.4						
	3.0	3.3	7.7	400	10.8	7.5	0.69	1.04	14.3	10.4						
110	1.5	0.5	1.1	300	8.5	6.0	0.71	1.17	12.5	7.3	Operation not recommended					
	1.5	0.5	1.1	400	8.9	6.8	0.77	1.22	13.1	7.3						
	2.3	1.6	3.6	300	9.1	6.2	0.68	1.12	12.9	8.1						
	2.3	1.6	3.6	400	9.4	7.0	0.74	1.16	13.4	8.1						
	3.0	3.2	7.3	300	9.4	6.3	0.67	1.09	13.1	8.6						
	3.0	3.2	7.3	400	9.8	7.1	0.73	1.14	13.7	8.6						
120	1.5	0.4	1.0	300	7.5	5.7	0.76	1.27	11.8	5.9	Operation not recommended					
	1.5	0.4	1.0	400	7.8	6.4	0.82	1.32	12.3	5.9						
	2.3	1.5	3.4	300	8.0	5.8	0.73	1.22	12.2	6.6						
	2.3	1.5	3.4	400	8.3	6.6	0.79	1.27	12.7	6.6						
	3.0	3.0	7.0	300	8.3	5.9	0.71	1.19	12.4	7.0						
	3.0	3.0	7.0	400	8.7	6.7	0.77	1.24	12.9	7.0						

Interpolation is permissible; extrapolation is not.
 All entering air conditions are 80°F DB and 67°F WB in cooling, and 70°F DB in heating.
 AHRI/ISO certified conditions are 80.6°F DB and 66.2°F WB in cooling and 68°F DB in heating.
 Table does not reflect fan or pump power corrections for AHRI/ISO conditions.
 All performance is based upon the lower voltage of dual voltage rated units.
 Performance stated is at the rated power supply; performance may vary as the power supply varies from the rated.
 Operation below 40°F EWT is based upon a 15% methanol antifreeze solution.
 Operation below 60°F EWT requires optional insulated water/refrigerant circuit.
 See performance correction tables for operating conditions other than those listed above.
 See Performance Data Selection Notes for operation in the shaded areas.

Performance Data – HBH/V 015 (PSC Blower)

525 CFM Nominal (Rated) Airflow

Performance capacities shown in thousands of Btuh

EWT °F	GPM	WPD		Cooling - EAT 80/67°F							Heating - EAT 70°F					
		PSI	FT	Airflow CFM	TC	SC	Sens/Tot Ratio	kW	HR	EER	Airflow CFM	HC	kW	HE	LAT	COP
20	3.8	4.1	9.5	Operation not recommended							395	9.5	1.07	6.1	92	2.62
	3.8	4.1	9.5								525	9.8	0.96	6.5	87	2.98
30	1.9	1.0	2.3	395	17.3	10.8	0.62	0.61	19.4	28.4	395	10.6	1.09	7.1	95	2.84
	1.9	1.0	2.3	525	18.1	12.2	0.67	0.64	20.2	28.4	525	10.9	0.98	7.5	89	3.24
	2.8	1.8	4.3	395	17.5	10.8	0.62	0.56	19.4	31.1	395	11.1	1.11	7.5	96	2.94
	2.8	1.8	4.3	525	18.2	12.2	0.67	0.59	20.2	31.1	525	11.4	0.99	8.0	90	3.35
	3.8	3.3	7.7	395	17.5	10.8	0.62	0.54	19.4	32.2	395	11.3	1.11	7.7	97	2.99
	3.8	3.3	7.7	525	18.3	12.2	0.67	0.57	20.2	32.2	525	11.6	1.00	8.2	90	3.41
40	1.9	0.8	1.8	395	17.0	10.6	0.63	0.68	19.3	24.8	395	12.3	1.13	8.5	99	3.18
	1.9	0.8	1.8	525	17.7	12.0	0.68	0.71	20.1	24.8	525	12.6	1.02	9.1	92	3.62
	2.8	1.6	3.6	395	17.2	10.7	0.62	0.63	19.4	27.3	395	12.8	1.14	9.0	100	3.29
	2.8	1.6	3.6	525	18.0	12.1	0.68	0.66	20.2	27.3	525	13.1	1.03	9.7	93	3.75
	3.8	2.9	6.6	395	17.4	10.8	0.62	0.60	19.4	28.8	395	13.1	1.15	9.3	101	3.35
	3.8	2.9	6.6	525	18.1	12.2	0.67	0.63	20.2	28.8	525	13.5	1.03	10.0	94	3.82
50	1.9	0.6	1.5	395	16.4	10.4	0.63	0.76	19.0	21.6	395	13.9	1.16	10.0	103	3.50
	1.9	0.6	1.5	525	17.1	11.8	0.69	0.79	19.8	21.6	525	14.2	1.05	10.7	95	3.99
	2.8	1.4	3.1	395	16.8	10.6	0.63	0.71	19.2	23.8	395	14.6	1.18	10.6	104	3.63
	2.8	1.4	3.1	525	17.5	12.0	0.68	0.74	20.0	23.8	525	14.9	1.06	11.3	96	4.13
	3.8	2.5	5.8	395	17.0	10.6	0.63	0.68	19.3	25.0	395	14.9	1.18	10.9	105	3.69
	3.8	2.5	5.8	525	17.7	12.0	0.68	0.71	20.1	25.0	525	15.3	1.06	11.7	97	4.21
60	1.9	0.6	1.3	395	15.7	10.2	0.65	0.84	18.6	18.7	395	15.5	1.20	11.5	106	3.81
	1.9	0.6	1.3	525	16.4	11.5	0.70	0.88	19.4	18.7	525	15.9	1.07	12.2	98	4.34
	2.8	1.2	2.8	395	16.2	10.4	0.64	0.79	18.9	20.5	395	16.3	1.21	12.1	108	3.94
	2.8	1.2	2.8	525	16.9	11.7	0.69	0.82	19.7	20.5	525	16.7	1.09	13.0	99	4.50
	3.8	2.3	5.3	395	16.4	10.4	0.63	0.76	19.0	21.6	395	16.7	1.22	12.5	109	4.02
	3.8	2.3	5.3	525	17.1	11.8	0.69	0.79	19.8	21.6	525	17.1	1.09	13.3	100	4.58
70	1.9	0.5	1.1	395	15.2	10.1	0.66	0.93	18.3	16.2	395	17.1	1.22	12.9	110	4.10
	1.9	0.5	1.1	525	15.8	11.4	0.72	0.97	19.1	16.3	525	17.5	1.10	13.8	101	4.68
	2.8	1.1	2.5	395	15.5	10.1	0.65	0.88	18.5	17.6	395	18.0	1.24	13.7	112	4.25
	2.8	1.1	2.5	525	16.1	11.4	0.71	0.91	19.2	17.6	525	18.4	1.11	14.6	102	4.85
	3.8	2.1	4.9	395	15.8	10.2	0.65	0.85	18.6	18.6	395	18.4	1.25	14.1	113	4.33
	3.8	2.1	4.9	525	16.4	11.5	0.70	0.88	19.4	18.6	525	18.8	1.12	15.0	103	4.94
80	1.9	0.4	1.0	395	14.3	9.8	0.68	1.03	17.8	13.9	395	18.7	1.25	14.3	114	4.38
	1.9	0.4	1.0	525	14.9	11.1	0.74	1.07	18.5	13.9	525	19.2	1.12	15.3	104	5.00
	2.8	1.0	2.4	395	14.7	9.8	0.67	0.97	18.0	15.1	395	19.6	1.27	15.1	116	4.54
	2.8	1.0	2.4	525	15.3	11.1	0.73	1.01	18.7	15.1	525	20.1	1.14	16.2	105	5.18
	3.8	2.0	4.6	395	14.9	9.9	0.66	0.94	18.2	15.9	395	20.1	1.27	15.6	117	4.62
	3.8	2.0	4.6	525	15.6	11.2	0.72	0.98	18.9	15.9	525	20.6	1.14	16.6	106	5.27
85	1.9	0.4	0.9	395	13.8	9.6	0.70	1.1	17.5	12.8	395	19.5	1.26	15.0	116	4.52
	1.9	0.4	0.9	525	14.4	10.9	0.76	1.13	18.2	12.8	525	19.9	1.13	16.0	105	5.15
	2.8	1.0	2.3	395	14.2	9.7	0.68	1.02	17.7	13.9	395	20.4	1.28	15.9	118	4.68
	2.8	1.0	2.3	525	14.8	11.0	0.74	1.07	18.4	13.9	525	20.9	1.15	16.9	107	5.34
	3.8	1.9	4.4	395	14.5	9.8	0.67	0.99	17.9	14.7	395	20.9	1.29	16.3	119	4.77
	3.8	1.9	4.4	525	15.1	11.1	0.73	1.03	18.6	14.7	525	21.4	1.15	17.4	108	5.43
90	1.9	0.4	0.9	395	13.3	9.5	0.71	1.14	17.2	11.7	395	20.2	1.28	15.7	117	4.65
	1.9	0.4	0.9	525	13.9	10.7	0.77	1.19	18.0	11.7	525	20.7	1.15	16.8	107	5.30
	2.8	1.0	2.2	395	13.7	9.5	0.69	1.08	17.4	12.8	395	21.2	1.29	16.6	120	4.82
	2.8	1.0	2.2	525	14.3	10.8	0.75	1.12	18.1	12.8	525	21.7	1.16	17.7	108	5.49
	3.8	1.9	4.3	395	14.1	9.6	0.69	1.04	17.6	13.5	395	21.7	1.30	17.1	121	4.90
	3.8	1.9	4.3	525	14.6	10.9	0.74	1.08	18.3	13.5	525	22.2	1.17	18.2	109	5.59
100	1.9	0.4	0.8	395	12.4	9.2	0.74	1.25	16.6	9.9	Operation not recommended					
	1.9	0.4	0.8	525	12.9	10.4	0.80	1.31	17.3	9.9						
	2.8	0.9	2.1	395	12.8	9.2	0.72	1.19	16.8	10.8						
	2.8	0.9	2.1	525	13.3	10.4	0.78	1.23	17.5	10.8						
	3.8	1.8	4.1	395	13.1	9.3	0.71	1.15	17.0	11.4						
	3.8	1.8	4.1	525	13.6	10.5	0.77	1.20	17.7	11.4						
110	1.9	0.3	0.7	395	11.3	8.8	0.78	1.37	16.0	8.3	Operation not recommended					
	1.9	0.3	0.7	525	11.8	10.0	0.84	1.43	16.7	8.3						
	2.8	0.8	1.9	395	11.8	8.9	0.75	1.30	16.2	9.0						
	2.8	0.8	1.9	525	12.2	10.0	0.82	1.36	16.9	9.0						
	3.8	1.7	3.9	395	12.1	9.0	0.74	1.27	16.4	9.5						
	3.8	1.7	3.9	525	12.6	10.2	0.81	1.32	17.1	9.5						
120	1.9	0.3	0.7	395	10.3	8.5	0.82	1.50	15.5	6.9	Operation not recommended					
	1.9	0.3	0.7	525	10.8	9.6	0.89	1.56	16.1	6.9						
	2.8	0.8	1.8	395	10.7	8.5	0.79	1.43	15.6	7.5						
	2.8	0.8	1.8	525	11.2	9.6	0.86	1.48	16.2	7.5						
	3.8	1.6	3.7	395	11.0	8.6	0.78	1.39	15.8	7.9						
	3.8	1.6	3.7	525	11.5	9.8	0.85	1.45	16.4	7.9						

Interpolation is permissible; extrapolation is not.
 All entering air conditions are 80°F DB and 67°F WB in cooling, and 70°F DB in heating.
 AHRI/ISO certified conditions are 80.6°F DB and 66.2°F WB in cooling and 68°F DB in heating.
 Table does not reflect fan or pump power corrections for AHRI/ISO conditions.
 All performance is based upon the lower voltage of dual voltage rated units.
 Performance stated is at the rated power supply; performance may vary as the power supply varies from the rated.
 Operation below 40°F EWT is based upon a 15% methanol antifreeze solution.
 Operation below 60°F EWT requires optional insulated water/refrigerant circuit.
 See performance correction tables for operating conditions other than those listed above.
 See Performance Data Selection Notes for operation in the shaded areas.

Performance Data – HBH/V 015 (ECM Blower)

500 CFM Nominal (Rated) Airflow

Performance capacities shown in thousands of Btu/h

EWT °F	GPM	WPD		Cooling - EAT 80/67°F							Heating - EAT 70°F					
		PSI	FT	Airflow CFM	TC	SC	Sens/Tot Ratio	kW	HR	EER	Airflow CFM	HC	kW	HE	LAT	COP
20	3.8	4.1	9.5	Operation not recommended							395	9.6	1.01	6.1	92.0	2.8
	3.8	4.1	9.5	Operation not recommended							525	9.6	0.90	6.5	87.0	3.1
30	1.9	1.0	2.3	395	17.3	10.8	0.62	0.55	19.2	31.3	395	10.6	1.03	7.1	95.0	3.0
	1.9	1.0	2.3	525	18.1	12.2	0.67	0.58	20.1	31.0	525	10.7	0.92	7.5	89.0	3.4
	2.8	1.8	4.3	395	17.5	10.8	0.62	0.50	19.2	34.8	395	11.1	1.05	7.5	96.0	3.1
	2.8	1.8	4.3	525	18.2	12.2	0.67	0.53	20.0	34.1	525	11.2	0.93	8.0	90.0	3.5
	3.8	3.3	7.7	395	17.5	10.8	0.62	0.48	19.1	36.2	395	11.3	1.05	7.7	97.0	3.1
	3.8	3.3	7.7	525	18.3	12.2	0.67	0.51	20.1	35.6	525	11.4	0.94	8.2	90.0	3.5
40	1.9	0.8	1.8	395	17.0	10.6	0.62	0.62	19.1	27.3	395	12.2	1.07	8.5	99.0	3.3
	1.9	0.8	1.8	525	17.7	12.0	0.68	0.65	19.9	27.1	525	12.4	0.96	9.1	92.0	3.8
	2.8	1.6	3.6	395	17.2	10.7	0.62	0.57	19.2	30.0	395	12.7	1.08	9.0	100.0	3.4
	2.8	1.6	3.6	525	18.0	12.1	0.67	0.60	20.1	29.8	525	13.0	0.97	9.7	93.0	3.9
	3.8	2.9	6.6	395	17.4	10.8	0.62	0.54	19.3	32.0	395	13.0	1.09	9.3	101.0	3.5
	3.8	2.9	6.6	525	18.1	12.2	0.67	0.57	20.1	31.6	525	13.3	0.97	10.0	94.0	4.0
50	1.9	0.6	1.5	395	16.4	10.4	0.63	0.70	18.8	23.3	395	13.8	1.10	10.0	103.0	3.7
	1.9	0.6	1.5	525	17.1	11.8	0.69	0.73	19.6	23.3	525	14.1	0.99	10.7	95.0	4.2
	2.8	1.4	3.1	395	16.8	10.6	0.63	0.65	19.0	25.7	395	14.4	1.12	10.6	104.0	3.8
	2.8	1.4	3.1	525	17.5	12.0	0.69	0.68	19.8	25.6	525	14.7	1.00	11.3	96.0	4.3
	3.8	2.5	5.8	395	17.0	10.6	0.62	0.62	19.1	27.3	395	14.7	1.12	10.9	105.0	3.8
	3.8	2.5	5.8	525	17.7	12.0	0.68	0.65	19.9	27.1	525	15.1	1.00	11.7	97.0	4.4
60	1.9	0.6	1.3	395	15.7	10.2	0.65	0.78	18.4	20.0	395	15.4	1.14	11.5	106.0	3.9
	1.9	0.6	1.3	525	16.4	11.5	0.70	0.82	19.2	19.9	525	15.7	1.01	12.2	98.0	4.5
	2.8	1.2	2.8	395	16.2	10.4	0.64	0.73	18.7	22.1	395	16.0	1.15	12.1	108.0	4.1
	2.8	1.2	2.8	525	16.9	11.7	0.69	0.76	19.5	22.1	525	16.5	1.03	13.0	99.0	4.7
	3.8	2.3	5.3	395	16.4	10.4	0.63	0.70	18.8	23.3	395	16.5	1.16	12.5	109.0	4.1
	3.8	2.3	5.3	525	17.1	11.8	0.69	0.73	19.6	23.3	525	16.8	1.03	13.3	100.0	4.8
70	1.9	0.5	1.1	395	15.2	10.1	0.66	0.87	18.2	17.4	395	16.9	1.16	12.9	110.0	4.2
	1.9	0.5	1.1	525	15.8	11.4	0.72	0.91	18.9	17.3	525	17.4	1.04	13.8	101.0	4.9
	2.8	1.1	2.5	395	15.5	10.1	0.65	0.82	18.3	18.8	395	17.7	1.18	13.7	112.0	4.4
	2.8	1.1	2.5	525	16.1	11.4	0.71	0.85	19.0	18.9	525	18.2	1.05	14.6	102.0	5.1
	3.8	2.1	4.9	395	15.8	10.2	0.65	0.79	18.5	19.9	395	18.2	1.19	14.1	113.0	4.5
	3.8	2.1	4.9	525	16.4	11.5	0.70	0.82	19.2	19.9	525	18.6	1.06	15.0	103.0	5.1
80	1.9	0.4	1.0	395	14.3	9.8	0.69	0.97	17.6	14.7	395	18.4	1.19	14.3	114.0	4.5
	1.9	0.4	1.0	525	14.9	11.1	0.74	1.01	18.4	14.7	525	18.9	1.06	15.3	104.0	5.2
	2.8	1.0	2.4	395	14.7	9.8	0.67	0.91	17.8	16.1	395	19.2	1.21	15.1	116.0	4.6
	2.8	1.0	2.4	525	15.3	11.1	0.73	0.95	18.6	16.0	525	19.9	1.08	16.2	105.0	5.4
	3.8	2.0	4.6	395	14.9	9.9	0.66	0.88	17.9	16.9	395	19.7	1.21	15.6	117.0	4.8
	3.8	2.0	4.6	525	15.6	11.2	0.72	0.92	18.8	16.9	525	20.3	1.08	16.6	106.0	5.5
85	1.9	0.4	0.9	395	13.8	9.6	0.70	1.04	17.4	13.2	395	19.1	1.20	15.0	116.0	4.7
	1.9	0.4	0.9	525	14.4	10.9	0.76	1.07	18.1	13.4	525	19.7	1.07	16.0	105.0	5.4
	2.8	1.0	2.3	395	14.2	9.7	0.68	0.96	17.5	14.7	395	20.1	1.22	15.9	118.0	4.8
	2.8	1.0	2.3	525	14.8	11.0	0.74	1.01	18.3	14.6	525	20.6	1.09	16.9	107.0	5.5
	3.8	1.9	4.4	395	14.5	9.8	0.68	0.93	17.7	15.5	395	20.5	1.23	16.3	119.0	4.9
	3.8	1.9	4.4	525	15.1	11.1	0.74	0.97	18.4	15.5	525	21.1	1.09	17.4	108.0	5.7
90	1.9	0.4	0.9	395	13.3	9.5	0.71	1.08	17.0	12.3	395	19.9	1.22	15.7	117.0	4.8
	1.9	0.4	0.9	525	13.9	10.7	0.77	1.13	17.8	12.3	525	20.5	1.09	16.8	107.0	5.5
	2.8	1.0	2.2	395	13.7	9.5	0.69	1.02	17.2	13.4	395	20.8	1.23	16.6	120.0	4.9
	2.8	1.0	2.2	525	14.3	10.8	0.76	1.06	17.9	13.4	525	21.5	1.10	17.7	108.0	5.7
	3.8	1.9	4.3	395	14.1	9.6	0.68	0.98	17.5	14.3	395	21.3	1.24	17.1	121.0	5.0
	3.8	1.9	4.3	525	14.6	10.9	0.75	1.02	18.1	14.3	525	22.0	1.11	18.2	109.0	5.8
100	1.9	0.4	0.8	395	12.4	9.2	0.74	1.19	16.5	10.4	Operation not recommended					
	1.9	0.4	0.8	525	12.9	10.4	0.81	1.25	17.2	10.3						
	2.8	0.9	2.1	395	12.8	9.2	0.72	1.13	16.7	11.3						
	2.8	0.9	2.1	525	13.3	10.4	0.78	1.17	17.3	11.3						
	3.8	1.8	4.1	395	13.1	9.3	0.71	1.09	16.8	12.0						
	3.8	1.8	4.1	525	13.6	10.5	0.77	1.14	17.5	11.9						
110	1.9	0.3	0.7	395	11.3	8.8	0.78	1.31	15.8	8.6						
	1.9	0.3	0.7	525	11.8	10.0	0.85	1.37	16.5	8.6						
	2.8	0.8	1.9	395	11.8	8.9	0.75	1.24	16.0	9.5						
	2.8	0.8	1.9	525	12.2	10.0	0.82	1.30	16.6	9.4						
	3.8	1.7	3.9	395	12.1	9.0	0.74	1.21	16.2	10.0						
	3.8	1.7	3.9	525	12.6	10.2	0.81	1.26	16.9	10.0						
120	1.9	0.3	0.7	395	10.3	8.5	0.83	1.44	15.2	7.1						
	1.9	0.3	0.7	525	10.8	9.6	0.89	1.50	15.9	7.2						
	2.8	0.8	1.8	395	10.7	8.5	0.79	1.37	15.4	7.8						
	2.8	0.8	1.8	525	11.2	9.6	0.86	1.42	16.1	7.9						
	3.8	1.6	3.7	395	11.0	8.6	0.78	1.33	15.5	8.2						
	3.8	1.6	3.7	525	11.5	9.8	0.85	1.39	16.3	8.3						

Interpolation is permissible; extrapolation is not.
 All entering air conditions are 80°F DB and 67°F WB in cooling, and 70°F DB in heating.
 AHR/ISO certified conditions are 80.6°F DB and 66.2°F WB in cooling and 68°F DB in heating.
 Table does not reflect fan or pump power corrections for AHR/ISO conditions.
 All performance is based upon the lower voltage of dual voltage rated units.
 Performance stated is at the rated power supply; performance may vary as the power supply varies from the rated.
 Operation below 40°F EWT is based upon a 15% methanol antifreeze solution.
 Operation below 60°F EWT requires optional insulated water/refrigerant circuit.
 See performance correction tables for operating conditions other than those listed above.
 See Performance Data Selection Notes for operation in the shaded areas.

Performance Data – HBH/V 018 (PSC Blower)

600 CFM Nominal (Rated) Airflow

Performance capacities shown in thousands of Btuh

EWT °F	GPM	WPD		Cooling - EAT 80/67°F							Heating - EAT 70°F					
		PSI	FT	Airflow CFM	TC	SC	Sens/Tot Ratio	kW	HR	EER	Airflow CFM	HC	kW	HE	LAT	COP
20	4.5	7.2	16.7	Operation not recommended							450	11.2	1.25	7.2	93	2.61
	4.5	7.2	16.7								600	11.4	1.13	7.6	88	2.98
30	2.3	2.1	4.9	450	22.1	14.2	0.64	0.72	24.5	30.7	450	12.4	1.29	8.2	96	2.83
	2.3	2.1	4.9	600	23.0	16.1	0.70	0.75	25.5	30.8	600	12.7	1.16	8.8	90	3.22
	3.4	3.4	7.9	450	22.9	14.4	0.63	0.64	25.1	35.8	450	12.9	1.30	8.7	97	2.92
	3.4	3.4	7.9	600	23.9	16.3	0.68	0.67	26.1	35.8	600	13.3	1.17	9.3	90	3.33
	4.5	5.9	13.7	450	23.3	14.4	0.62	0.60	25.3	39.0	450	13.2	1.31	9.0	97	2.97
	4.5	5.9	13.7	600	24.3	16.3	0.67	0.62	26.4	39.0	600	13.5	1.17	9.6	91	3.38
40	2.3	1.7	3.9	450	21.1	13.9	0.66	0.82	23.9	25.6	450	14.3	1.33	9.9	99	3.15
	2.3	1.7	3.9	600	22.0	15.7	0.72	0.86	24.9	25.6	600	14.7	1.20	10.6	93	3.59
	3.4	2.9	6.7	450	21.9	14.2	0.65	0.75	24.4	29.3	450	15.0	1.35	10.5	101	3.26
	3.4	2.9	6.7	600	22.8	16.0	0.70	0.78	25.4	29.3	600	15.3	1.21	11.2	94	3.72
	4.5	5.1	11.8	450	22.5	14.5	0.64	0.71	24.9	31.9	450	15.3	1.35	10.8	102	3.32
	4.5	5.1	11.8	600	23.5	16.4	0.70	0.74	25.9	31.9	600	15.7	1.22	11.6	94	3.78
50	2.3	1.4	3.3	450	20.4	13.7	0.67	0.93	23.5	21.9	450	16.3	1.37	11.7	103	3.47
	2.3	1.4	3.3	600	21.2	15.5	0.73	0.97	24.5	22.0	600	16.6	1.23	12.5	96	3.96
	3.4	2.6	5.9	450	20.8	13.8	0.66	0.85	23.7	24.4	450	17.0	1.39	12.4	105	3.60
	3.4	2.6	5.9	600	21.7	15.6	0.72	0.89	24.7	24.4	600	17.4	1.25	13.2	97	4.10
	4.5	4.6	10.6	450	21.2	13.9	0.66	0.81	23.9	26.1	450	17.4	1.39	12.7	106	3.67
	4.5	4.6	10.6	600	22.1	15.8	0.72	0.85	24.9	26.1	600	17.9	1.25	13.6	98	4.18
60	2.3	1.3	2.9	450	19.3	13.2	0.68	1.04	22.8	18.6	450	18.2	1.41	13.4	107	3.79
	2.3	1.3	2.9	600	20.1	14.9	0.74	1.08	23.8	18.6	600	18.6	1.26	14.3	99	4.32
	3.4	2.3	5.3	450	19.8	13.4	0.68	0.96	23.0	20.6	450	19.1	1.42	14.2	109	3.93
	3.4	2.3	5.3	600	20.6	15.1	0.73	1.00	24.0	20.6	600	19.6	1.28	15.2	100	4.49
	4.5	4.2	9.6	450	20.1	13.5	0.67	0.92	23.3	21.9	450	19.6	1.43	14.7	110	4.01
	4.5	4.2	9.6	600	21.0	15.3	0.73	0.96	24.2	21.9	600	20.1	1.29	15.7	101	4.58
70	2.3	1.1	2.6	450	18.2	12.7	0.69	1.15	22.1	15.8	450	20.2	1.44	15.2	112	4.11
	2.3	1.1	2.6	600	19.0	14.3	0.76	1.20	23.1	15.8	600	20.7	1.29	16.2	102	4.68
	3.4	2.1	4.9	450	18.7	12.8	0.69	1.07	22.3	17.4	450	21.2	1.46	16.1	114	4.27
	3.4	2.1	4.9	600	19.4	14.5	0.75	1.12	23.2	17.4	600	21.7	1.31	17.2	103	4.86
	4.5	3.9	8.9	450	19.1	13.0	0.68	1.03	22.6	18.4	450	21.7	1.46	16.6	115	4.35
	4.5	3.9	8.9	600	19.8	14.7	0.74	1.08	23.5	18.4	600	22.3	1.32	17.8	104	4.96
80	2.3	1.0	2.3	450	17.0	12.1	0.71	1.28	21.4	13.3	450	22.1	1.47	17.0	116	4.41
	2.3	1.0	2.3	600	17.7	13.7	0.77	1.33	22.3	13.3	600	22.7	1.32	18.2	105	5.03
	3.4	2.0	4.5	450	17.5	12.3	0.70	1.20	21.6	14.7	450	23.3	1.49	18.0	118	4.59
	3.4	2.0	4.5	600	18.3	13.9	0.76	1.25	22.5	14.7	600	23.9	1.34	19.3	107	5.23
	4.5	3.6	8.3	450	17.9	12.5	0.69	1.15	21.9	15.5	450	23.9	1.50	18.6	119	4.68
	4.5	3.6	8.3	600	18.7	14.1	0.76	1.20	22.8	15.5	600	24.5	1.35	19.9	108	5.34
85	2.3	1.0	2.2	450	16.4	11.8	0.72	1.35	21.0	12.2	450	23.1	1.49	17.9	118	4.56
	2.3	1.0	2.2	600	17.1	13.3	0.78	1.40	21.9	12.2	600	23.7	1.33	19.1	107	5.20
	3.4	1.9	4.4	450	16.9	12.0	0.71	1.26	21.2	13.5	450	24.3	1.50	19.0	120	4.74
	3.4	1.9	4.4	600	17.6	13.5	0.77	1.31	22.1	13.5	600	24.9	1.35	20.3	108	5.41
	4.5	3.5	8.1	450	17.3	12.2	0.70	1.22	21.5	14.3	450	25.0	1.51	19.6	121	4.84
	4.5	3.5	8.1	600	18.0	13.8	0.76	1.27	22.4	14.3	600	25.6	1.36	20.9	110	5.51
90	2.3	0.9	2.1	450	15.8	11.5	0.73	1.42	20.6	11.1	450	24.1	1.50	18.8	120	4.71
	2.3	0.9	2.1	600	16.4	13.0	0.79	1.48	21.5	11.1	600	24.7	1.35	20.1	108	5.37
	3.4	1.8	4.2	450	16.3	11.7	0.71	1.33	20.8	12.3	450	25.4	1.52	20.0	122	4.89
	3.4	1.8	4.2	600	17.0	13.2	0.78	1.38	21.7	12.3	600	26.0	1.37	21.3	110	5.58
	4.5	3.4	7.9	450	16.7	11.9	0.71	1.28	21.1	13.0	450	26.1	1.53	20.6	124	4.99
	4.5	3.4	7.9	600	17.4	13.4	0.77	1.34	22.0	13.0	600	26.7	1.38	22.0	111	5.69
100	2.3	0.9	2.0	450	14.4	10.8	0.75	1.57	19.8	9.2	Operation not recommended					
	2.3	0.9	2.0	600	15.0	12.2	0.82	1.63	20.6	9.2						
	3.4	1.7	4.0	450	15.0	11.0	0.74	1.48	20.0	10.1						
	3.4	1.7	4.0	600	15.6	12.5	0.80	1.54	20.8	10.1						
	4.5	3.2	7.4	450	15.4	11.2	0.73	1.43	20.3	10.8						
	4.5	3.2	7.4	600	16.0	12.7	0.79	1.49	21.1	10.8						
110	2.3	0.8	1.8	450	12.9	10.1	0.78	1.74	18.8	7.4	Operation not recommended					
	2.3	0.8	1.8	600	13.4	11.4	0.85	1.81	19.6	7.4						
	3.4	1.6	3.8	450	13.5	10.3	0.76	1.64	19.1	8.2						
	3.4	1.6	3.8	600	14.0	11.6	0.83	1.71	19.9	8.2						
	4.5	3.1	7.1	450	13.9	10.5	0.75	1.59	19.4	8.8						
	4.5	3.1	7.1	600	14.5	11.9	0.82	1.65	20.2	8.8						
120	2.3	0.7	1.7	450	11.2	9.2	0.82	1.92	17.8	5.8	Operation not recommended					
	2.3	0.7	1.7	600	11.6	10.4	0.89	2.00	18.5	5.8						
	3.4	1.6	3.6	450	11.8	9.5	0.80	1.82	18.1	6.5						
	3.4	1.6	3.6	600	12.3	10.7	0.87	1.89	18.8	6.5						
	4.5	2.9	6.8	450	12.3	9.7	0.79	1.77	18.4	7.0						
	4.5	2.9	6.8	600	12.8	11.0	0.86	1.84	19.1	7.0						

Interpolation is permissible; extrapolation is not.
 All entering air conditions are 80°F DB and 67°F WB in cooling, and 70°F DB in heating.
 AHRI/ISO certified conditions are 80.6°F DB and 66.2°F WB in cooling and 68°F DB in heating.
 Table does not reflect fan or pump power corrections for AHRI/ISO conditions.
 All performance is based upon the lower voltage of dual voltage rated units.
 Performance stated is at the rated power supply; performance may vary as the power supply varies from the rated.
 Operation below 40°F EWT is based upon a 15% methanol antifreeze solution.
 Operation below 60°F EWT requires optional insulated water/refrigerant circuit.
 See performance correction tables for operating conditions other than those listed above.
 See Performance Data Selection Notes for operation in the shaded areas.

Performance Data – HBH/V 018 (ECM Blower)

600 CFM Nominal (Rated) Airflow

Performance capacities shown in thousands of Btu/h

EWT °F	GPM	WPD		Cooling - EAT 80/67°F							Heating - EAT 70°F					
		PSI	FT	Airflow CFM	TC	SC	Sens/Tot Ratio	kW	HR	EER	Airflow CFM	HC	kW	HE	LAT	COP
20	4.5	7.2	16.7	Operation not recommended							450	11.3	1.20	7.2	92.0	2.8
	4.5	7.2	16.7	Operation not recommended							600	11.2	1.10	7.6	87.0	3.1
30	2.3	2.1	4.9	450	22.1	14.2	0.64	0.66	24.3	33.5	450	12.4	1.20	8.2	95.0	3.0
	2.3	2.1	4.9	600	23.0	16.1	0.70	0.69	25.4	33.4	600	12.5	1.10	8.8	89.0	3.3
	3.4	3.4	7.9	450	22.9	14.4	0.63	0.58	24.9	39.6	450	12.9	1.20	8.7	96.0	3.1
	3.4	3.4	7.9	600	23.9	16.3	0.68	0.61	26.0	39.2	600	13.1	1.10	9.3	90.0	3.5
	4.5	5.9	13.7	450	23.3	14.4	0.62	0.54	25.1	43.2	450	13.3	1.20	9.0	97.0	3.1
	4.5	5.9	13.7	600	24.3	16.3	0.67	0.56	26.2	43.5	600	13.4	1.10	9.6	90.0	3.5
40	2.3	1.7	3.9	450	21.1	13.9	0.66	0.76	23.7	27.8	450	14.2	1.30	9.9	99.0	3.3
	2.3	1.7	3.9	600	22.0	15.7	0.71	0.80	24.7	27.5	600	14.5	1.10	10.6	92.0	3.7
	3.4	2.9	6.7	450	21.9	14.2	0.65	0.69	24.3	31.8	450	14.9	1.30	10.5	100.0	3.4
	3.4	2.9	6.7	600	22.8	16.0	0.70	0.72	25.3	31.7	600	15.1	1.10	11.2	93.0	3.9
	4.5	5.1	11.8	450	22.5	14.5	0.64	0.65	24.7	34.7	450	15.2	1.30	10.8	101.0	3.5
	4.5	5.1	11.8	600	23.5	16.4	0.70	0.68	25.8	34.6	600	15.6	1.20	11.6	94.0	3.9
50	2.3	1.4	3.3	450	20.4	13.7	0.67	0.87	23.4	23.5	450	16.2	1.30	11.7	103.0	3.6
	2.3	1.4	3.3	600	21.2	15.5	0.73	0.91	24.3	23.3	600	16.5	1.20	12.5	95.0	4.1
	3.4	2.6	5.9	450	20.8	13.8	0.66	0.79	23.5	26.4	450	16.9	1.30	12.4	104.0	3.7
	3.4	2.6	5.9	600	21.7	15.6	0.72	0.83	24.5	26.2	600	17.3	1.20	13.2	96.0	4.3
	4.5	4.6	10.6	450	21.2	13.9	0.66	0.75	23.8	28.3	450	17.2	1.30	12.7	105.0	3.8
	4.5	4.6	10.6	600	22.1	15.8	0.71	0.79	24.8	28.0	600	17.7	1.20	13.6	97.0	4.4
60	2.3	1.3	2.9	450	19.3	13.2	0.68	0.98	22.6	19.7	450	18.0	1.30	13.4	106.0	3.9
	2.3	1.3	2.9	600	20.1	14.9	0.74	1.02	23.6	19.7	600	18.4	1.20	14.3	98.0	4.5
	3.4	2.3	5.3	450	19.8	13.4	0.68	0.90	22.9	22.0	450	18.8	1.40	14.2	108.0	4.1
	3.4	2.3	5.3	600	20.6	15.1	0.73	0.94	23.8	21.9	600	19.4	1.20	15.2	99.0	4.7
	4.5	4.2	9.6	450	20.1	13.5	0.67	0.86	23.0	23.4	450	19.4	1.40	14.7	109.0	4.1
	4.5	4.2	9.6	600	21.0	15.3	0.73	0.90	24.1	23.4	600	19.9	1.20	15.7	100.0	4.7
70	2.3	1.1	2.6	450	18.2	12.7	0.70	1.09	21.9	16.7	450	19.9	1.40	15.2	110.0	4.2
	2.3	1.1	2.6	600	19.0	14.3	0.75	1.14	22.9	16.7	600	20.4	1.20	16.2	101.0	4.9
	3.4	2.1	4.9	450	18.7	12.8	0.68	1.01	22.1	18.5	450	20.9	1.40	16.1	112.0	4.4
	3.4	2.1	4.9	600	19.4	14.5	0.75	1.06	23.0	18.3	600	21.5	1.20	17.2	102.0	5.0
	4.5	3.9	8.9	450	19.1	13.0	0.68	0.97	22.4	19.7	450	21.4	1.40	16.6	113.0	4.5
	4.5	3.9	8.9	600	19.8	14.7	0.74	1.02	23.3	19.4	600	22.1	1.30	17.8	103.0	5.1
80	2.3	1.0	2.3	450	17.0	12.1	0.71	1.22	21.2	13.9	450	21.8	1.40	17.0	114.0	4.5
	2.3	1.0	2.3	600	17.7	13.7	0.77	1.27	22.0	13.9	600	22.5	1.30	18.2	104.0	5.2
	3.4	2.0	4.5	450	17.5	12.3	0.70	1.14	21.4	15.4	450	22.9	1.40	18.0	116.0	4.7
	3.4	2.0	4.5	600	18.3	13.9	0.76	1.19	22.4	15.4	600	23.7	1.30	19.3	105.0	5.4
	4.5	3.6	8.3	450	17.9	12.5	0.70	1.09	21.6	16.4	450	23.5	1.40	18.6	117.0	4.8
	4.5	3.6	8.3	600	18.7	14.1	0.75	1.14	22.6	16.4	600	24.3	1.30	19.9	106.0	5.5
85	2.3	1.0	2.2	450	16.4	11.8	0.72	1.29	20.8	12.7	450	22.8	1.40	17.9	116.0	4.7
	2.3	1.0	2.2	600	17.1	13.3	0.78	1.34	21.7	12.8	600	23.4	1.30	19.1	105.0	5.4
	3.4	1.9	4.4	450	16.9	12.0	0.71	1.20	21.0	14.1	450	23.9	1.40	19.0	118.0	4.9
	3.4	1.9	4.4	600	17.6	13.5	0.77	1.25	21.9	14.1	600	24.7	1.30	20.3	107.0	5.6
	4.5	3.5	8.1	450	17.3	12.2	0.71	1.16	21.3	14.9	450	24.5	1.40	19.6	119.0	5.0
	4.5	3.5	8.1	600	18.0	13.8	0.77	1.21	22.1	14.9	600	25.3	1.30	20.9	108.0	5.7
90	2.3	0.9	2.1	450	15.8	11.5	0.73	1.36	20.4	11.6	450	23.7	1.40	18.8	117.0	4.8
	2.3	0.9	2.1	600	16.4	13.0	0.79	1.42	21.2	11.6	600	24.5	1.30	20.1	107.0	5.6
	3.4	1.8	4.2	450	16.3	11.7	0.72	1.27	20.6	12.8	450	25.0	1.50	20.0	120.0	5.0
	3.4	1.8	4.2	600	17.0	13.2	0.78	1.32	21.5	12.9	600	25.8	1.30	21.3	108.0	5.8
	4.5	3.4	7.9	450	16.7	11.9	0.71	1.22	20.9	13.7	450	25.6	1.50	20.6	121.0	5.1
	4.5	3.4	7.9	600	17.4	13.4	0.77	1.28	21.8	13.6	600	26.5	1.30	22.0	109.0	5.9
100	2.3	0.9	2.0	450	14.4	10.8	0.75	1.51	19.5	9.5	Operation not recommended					
	2.3	0.9	2.0	600	15.0	12.2	0.81	1.57	20.4	9.6						
	3.4	1.7	4.0	450	15.0	11.0	0.73	1.42	19.8	10.6						
	3.4	1.7	4.0	600	15.6	12.5	0.80	1.48	20.6	10.5						
	4.5	3.2	7.4	450	15.4	11.2	0.73	1.37	20.1	11.2						
	4.5	3.2	7.4	600	16.0	12.7	0.79	1.43	20.9	11.2						
110	2.3	0.8	1.8	450	12.9	10.1	0.78	1.68	18.6	7.7						
	2.3	0.8	1.8	600	13.4	11.4	0.85	1.75	19.4	7.7						
	3.4	1.6	3.8	450	13.5	10.3	0.76	1.58	18.9	8.5						
	3.4	1.6	3.8	600	14.0	11.6	0.83	1.65	19.6	8.5						
	4.5	3.1	7.1	450	13.9	10.5	0.76	1.53	19.1	9.1						
	4.5	3.1	7.1	600	14.5	11.9	0.82	1.59	19.9	9.1						
120	2.3	0.7	1.7	450	11.2	9.2	0.82	1.86	17.5	6.0						
	2.3	0.7	1.7	600	11.6	10.4	0.90	1.94	18.2	6.0						
	3.4	1.6	3.6	450	11.8	9.5	0.81	1.76	17.8	6.7						
	3.4	1.6	3.6	600	12.3	10.7	0.87	1.83	18.5	6.7						
	4.5	2.9	6.8	450	12.3	9.7	0.79	1.71	18.1	7.2						
	4.5	2.9	6.8	600	12.8	11.0	0.86	1.78	18.9	7.2						

Interpolation is permissible; extrapolation is not.
 All entering air conditions are 80°F DB and 67°F WB in cooling, and 70°F DB in heating.
 AHRI/ISO certified conditions are 80.6°F DB and 66.2°F WB in cooling and 68°F DB in heating.
 Table does not reflect fan or pump power corrections for AHRI/ISO conditions.
 All performance is based upon the lower voltage of dual voltage rated units.
 Performance stated is at the rated power supply; performance may vary as the power supply varies from the rated.
 Operation below 40°F EWT is based upon a 15% methanol antifreeze solution.
 Operation below 60°F EWT requires optional insulated water/refrigerant circuit.
 See performance correction tables for operating conditions other than those listed above.
 See Performance Data Selection Notes for operation in the shaded areas.

Performance Data – HBH/V 024 (PSC Blower)

800 CFM Nominal (Rated) Airflow

Performance capacities shown in thousands of Btu/h

EWT °F	GPM	WPD		Cooling - EAT 80/67°F							Heating - EAT 70°F					
		PSI	FT	Airflow CFM	TC	SC	Sens/Tot Ratio	kW	HR	EER	Airflow CFM	HC	kW	HE	LAT	COP
20	6.0	8.5	19.6	Operation not recommended							640	15.5	1.91	9.5	92	2.39
	6.0	8.5	19.6	Operation not recommended							850	15.9	1.71	10.1	87	2.72
30	3.0	2.2	5.2	640	27.7	17.4	0.63	1.12	31.5	24.8	640	17.2	1.93	11.0	95	2.61
	3.0	2.2	5.2	850	28.9	19.7	0.68	1.16	32.8	24.8	850	17.6	1.74	11.8	89	2.98
	4.5	4.0	9.3	640	28.2	17.5	0.62	1.05	31.8	26.9	640	18.0	1.95	11.7	96	2.70
	4.5	4.0	9.3	850	29.4	19.8	0.67	1.09	33.1	26.9	850	18.4	1.75	12.5	90	3.08
	6.0	7.2	16.7	640	28.5	17.5	0.62	1.02	31.9	28.0	640	18.4	1.95	12.1	97	2.76
	6.0	7.2	16.7	850	29.6	19.8	0.67	1.06	33.2	28.0	850	18.8	1.76	12.9	91	3.14
40	3.0	1.9	4.4	640	26.9	17.1	0.64	1.23	31.1	21.9	640	19.9	1.98	13.4	99	2.94
	3.0	1.9	4.4	850	28.0	19.4	0.69	1.28	32.4	21.9	850	20.4	1.78	14.4	92	3.36
	4.5	3.6	8.2	640	27.5	17.3	0.63	1.15	31.4	24.0	640	20.8	2.00	14.3	100	3.06
	4.5	3.6	8.2	850	28.7	19.6	0.68	1.19	32.7	24.0	850	21.3	1.79	15.3	93	3.49
	6.0	6.4	14.9	640	27.8	17.4	0.63	1.11	31.5	25.1	640	21.3	2.01	14.7	101	3.12
	6.0	6.4	14.9	850	28.9	19.7	0.68	1.16	32.8	25.1	850	21.9	1.80	15.7	94	3.55
50	3.0	1.7	3.9	640	26.2	16.9	0.65	1.36	30.8	19.3	640	22.6	2.03	15.9	103	3.27
	3.0	1.7	3.9	850	27.3	19.1	0.70	1.42	32.1	19.3	850	23.2	1.82	17.0	95	3.72
	4.5	3.2	7.4	640	26.7	17.0	0.64	1.26	31.0	21.1	640	23.7	2.05	16.9	104	3.39
	4.5	3.2	7.4	850	27.8	19.3	0.69	1.32	32.2	21.1	850	24.3	1.84	18.0	96	3.87
	6.0	5.9	13.6	640	27.0	17.1	0.64	1.22	31.1	22.1	640	24.3	2.06	17.4	105	3.46
	6.0	5.9	13.6	850	28.1	19.4	0.69	1.27	32.4	22.1	850	24.9	1.85	18.6	97	3.94
60	3.0	1.5	3.5	640	25.3	16.6	0.66	1.52	30.4	16.7	640	25.3	2.08	18.3	107	3.57
	3.0	1.5	3.5	850	26.3	18.8	0.71	1.58	31.7	16.7	850	25.9	1.87	19.6	98	4.07
	4.5	3.0	6.9	640	25.7	16.7	0.65	1.40	30.5	18.3	640	26.6	2.10	19.4	108	3.70
	4.5	3.0	6.9	850	26.8	18.9	0.70	1.46	31.7	18.3	850	27.2	1.89	20.7	100	4.22
	6.0	5.5	12.6	640	26.1	16.8	0.64	1.35	30.6	19.3	640	27.2	2.12	20.0	109	3.77
	6.0	5.5	12.6	850	27.1	19.0	0.70	1.41	31.9	19.3	850	27.9	1.90	21.4	100	4.30
70	3.0	1.4	3.2	640	24.1	16.2	0.67	1.70	29.9	14.2	640	27.9	2.13	20.7	110	3.84
	3.0	1.4	3.2	850	25.1	18.3	0.73	1.77	31.1	14.2	850	28.6	1.91	22.1	101	4.38
	4.5	2.8	6.4	640	24.6	16.3	0.66	1.57	30.0	15.7	640	29.2	2.16	21.8	112	3.97
	4.5	2.8	6.4	850	25.6	18.4	0.72	1.63	31.2	15.7	850	29.9	1.94	23.3	103	4.53
	6.0	5.2	11.9	640	25.0	16.4	0.66	1.51	30.1	16.6	640	29.9	2.17	22.5	113	4.04
	6.0	5.2	11.9	850	26.0	18.6	0.71	1.57	31.4	16.6	850	30.6	1.95	24.0	103	4.60
80	3.0	1.3	3.0	640	22.9	15.7	0.69	1.91	29.4	12.0	640	30.4	2.18	22.9	114	4.08
	3.0	1.3	3.0	850	23.8	17.8	0.75	1.99	30.6	12.0	850	31.1	1.96	24.4	104	4.65
	4.5	2.6	6.1	640	23.4	15.8	0.67	1.76	29.4	13.3	640	31.7	2.21	24.0	116	4.20
	4.5	2.6	6.1	850	24.4	17.9	0.73	1.84	30.7	13.3	850	32.5	1.99	25.7	105	4.79
	6.0	4.9	11.3	640	23.8	16.0	0.67	1.70	29.6	14.1	640	32.4	2.23	24.6	117	4.26
	6.0	4.9	11.3	850	24.8	18.1	0.73	1.77	30.8	14.1	850	33.1	2.00	26.3	106	4.85
85	3.0	1.3	2.9	640	22.2	15.5	0.70	2.03	29.2	11.0	640	31.5	2.21	23.8	116	4.18
	3.0	1.3	2.9	850	23.1	17.5	0.76	2.12	30.4	11.0	850	32.3	1.98	25.5	105	4.77
	4.5	2.6	5.9	640	22.8	15.6	0.68	1.88	29.2	12.2	640	32.7	2.24	25.0	117	4.29
	4.5	2.6	5.9	850	23.7	17.6	0.74	1.95	30.4	12.2	850	33.5	2.01	26.7	107	4.89
	6.0	4.8	11.0	640	23.2	15.7	0.68	1.80	29.3	12.9	640	33.4	2.25	25.5	118	4.34
	6.0	4.8	11.0	850	24.1	17.8	0.74	1.88	30.5	12.9	850	34.2	2.02	27.2	107	4.95
90	3.0	1.2	2.8	640	21.6	15.3	0.71	2.16	28.9	10.0	640	32.6	2.23	24.8	117	4.28
	3.0	1.2	2.8	850	22.4	17.3	0.77	2.25	30.1	10.0	850	33.4	2.01	26.5	106	4.88
	4.5	2.5	5.8	640	22.2	15.4	0.69	1.99	29.0	11.1	640	33.8	2.26	25.9	119	4.38
	4.5	2.5	5.8	850	23.1	17.4	0.75	2.07	30.1	11.1	850	34.6	2.03	27.6	108	4.99
	6.0	4.7	10.7	640	22.5	15.4	0.69	1.91	29.0	11.8	640	34.4	2.28	26.4	120	4.42
	6.0	4.7	10.7	850	23.4	17.5	0.75	1.99	30.2	11.8	850	35.2	2.05	28.2	108	5.04
100	3.0	1.2	2.7	640	20.2	14.8	0.74	2.44	28.5	8.3	Operation not recommended					
	3.0	1.2	2.7	850	21.0	16.8	0.80	2.54	29.7	8.3						
	4.5	2.4	5.5	640	20.8	14.9	0.72	2.25	28.5	9.2						
	4.5	2.4	5.5	850	21.6	16.9	0.78	2.34	29.7	9.2						
	6.0	4.5	10.3	640	21.1	15.0	0.71	2.16	28.5	9.8						
	6.0	4.5	10.3	850	22.0	17.0	0.77	2.25	29.7	9.8						
110	3.0	1.1	2.5	640	18.8	14.4	0.77	2.77	28.3	6.8						
	3.0	1.1	2.5	850	19.5	16.3	0.84	2.88	29.4	6.8						
	4.5	2.3	5.3	640	19.3	14.4	0.75	2.55	28.1	7.6						
	4.5	2.3	5.3	850	20.1	16.3	0.81	2.66	29.2	7.6						
	6.0	4.3	9.9	640	19.7	14.5	0.74	2.45	28.1	8.0						
	6.0	4.3	9.9	850	20.5	16.4	0.80	2.55	29.3	8.0						
120	3.0	1.0	2.4	640	17.1	13.9	0.81	3.13	27.9	5.5						
	3.0	1.0	2.4	850	17.8	15.7	0.88	3.26	29.0	5.5						
	4.5	2.2	5.1	640	17.8	14.0	0.78	2.89	27.8	6.2						
	4.5	2.2	5.1	850	18.6	15.8	0.85	3.01	28.9	6.2						
	6.0	4.2	9.6	640	18.3	14.1	0.77	2.78	27.9	6.6						
	6.0	4.2	9.6	850	19.1	16.0	0.84	2.89	29.0	6.6						

Interpolation is permissible; extrapolation is not.
 All entering air conditions are 80°F DB and 67°F WB in cooling, and 70°F DB in heating.
 AHRI/ISO certified conditions are 80.6°F DB and 66.2°F WB in cooling and 68°F DB in heating.
 Table does not reflect fan or pump power corrections for AHRI/ISO conditions.
 All performance is based upon the lower voltage of dual voltage rated units.
 Performance stated is at the rated power supply; performance may vary as the power supply varies from the rated.
 Operation below 40°F EWT is based upon a 15% methanol antifreeze solution.
 Operation below 60°F EWT requires optional insulated water/refrigerant circuit.
 See performance correction tables for operating conditions other than those listed above.
 See Performance Data Selection Notes for operation in the shaded areas.

Performance Data – HBH/V 024 (ECM Blower)

800 CFM Nominal (Rated) Airflow

Performance capacities shown in thousands of Btu/h

EWT °F	GPM	WPD		Cooling - EAT 80/67°F							Heating - EAT 70°F					
		PSI	FT	Airflow CFM	TC	SC	Sens/Tot Ratio	kW	HR	EER	Airflow CFM	HC	kW	HE	LAT	COP
20	6.0	8.5	19.6	Operation not recommended							640	15.9	1.87	9.5	92.0	2.5
	6.0	8.5	19.6								850	15.8	1.67	10.1	87.0	2.8
30	3.0	2.2	5.2	640	27.7	17.4	0.63	1.08	31.4	25.6	640	17.5	1.89	11.0	95.0	2.7
	3.0	2.2	5.2	850	28.9	19.7	0.68	1.12	32.7	25.8	850	17.6	1.70	11.8	89.0	3.0
	4.5	4.0	9.3	640	28.2	17.5	0.62	1.01	31.7	27.9	640	18.2	1.91	11.7	96.0	2.8
	4.5	4.0	9.3	850	29.4	19.8	0.67	1.05	33.0	28.0	850	18.3	1.71	12.5	90.0	3.1
	6.0	7.2	16.7	640	28.5	17.5	0.61	0.98	31.8	29.0	640	18.6	1.91	12.1	97.0	2.9
	6.0	7.2	16.7	850	29.6	19.8	0.67	1.02	33.1	29.0	850	18.8	1.72	12.9	90.0	3.2
40	3.0	1.9	4.4	640	26.9	17.1	0.64	1.19	31.0	22.6	640	20.0	1.94	13.4	99.0	3.0
	3.0	1.9	4.4	850	28.0	19.4	0.69	1.24	32.2	22.6	850	20.3	1.74	14.4	92.0	3.4
	4.5	3.6	8.2	640	27.5	17.3	0.63	1.11	31.3	24.7	640	21.0	1.96	14.3	100.0	3.1
	4.5	3.6	8.2	850	28.7	19.6	0.68	1.15	32.6	24.9	850	21.3	1.75	15.3	93.0	3.6
	6.0	6.4	14.9	640	27.8	17.4	0.63	1.07	31.5	25.9	640	21.4	1.97	14.7	101.0	3.2
	6.0	6.4	14.9	850	28.9	19.7	0.68	1.12	32.7	25.8	850	21.7	1.76	15.7	94.0	3.6
50	3.0	1.7	3.9	640	26.2	16.9	0.65	1.32	30.7	19.8	640	22.7	1.99	15.9	103.0	3.3
	3.0	1.7	3.9	850	27.3	19.1	0.70	1.38	32.0	19.8	850	23.1	1.78	17.0	95.0	3.8
	4.5	3.2	7.4	640	26.7	17.0	0.64	1.22	30.9	21.9	640	23.8	2.01	16.9	104.0	3.5
	4.5	3.2	7.4	850	27.8	19.3	0.69	1.28	32.2	21.7	850	24.1	1.80	18.0	96.0	3.9
	6.0	5.9	13.6	640	27.0	17.1	0.63	1.18	31.0	22.9	640	24.3	2.02	17.4	105.0	3.5
	6.0	5.9	13.6	850	28.1	19.4	0.69	1.23	32.3	22.8	850	24.8	1.81	18.6	97.0	4.0
60	3.0	1.5	3.5	640	25.3	16.6	0.66	1.48	30.4	17.1	640	25.3	2.04	18.3	106.0	3.6
	3.0	1.5	3.5	850	26.3	18.8	0.71	1.54	31.6	17.1	850	25.8	1.83	19.6	98.0	4.1
	4.5	3.0	6.9	640	25.7	16.7	0.65	1.36	30.3	18.9	640	26.4	2.06	19.4	108.0	3.8
	4.5	3.0	6.9	850	26.8	18.9	0.71	1.42	31.6	18.9	850	27.0	1.85	20.7	99.0	4.3
	6.0	5.5	12.6	640	26.1	16.8	0.64	1.31	30.6	19.9	640	27.1	2.08	20.0	109.0	3.8
	6.0	5.5	12.6	850	27.1	19.0	0.70	1.37	31.8	19.8	850	27.8	1.86	21.4	100.0	4.4
70	3.0	1.4	3.2	640	24.1	16.2	0.67	1.66	29.8	14.5	640	27.8	2.09	20.7	110.0	3.9
	3.0	1.4	3.2	850	25.1	18.3	0.73	1.73	31.0	14.5	850	28.5	1.87	22.1	101.0	4.5
	4.5	2.8	6.4	640	24.6	16.3	0.66	1.53	29.8	16.1	640	29.0	2.12	21.8	112.0	4.0
	4.5	2.8	6.4	850	25.6	18.4	0.72	1.59	31.0	16.1	850	29.8	1.90	23.3	102.0	4.6
	6.0	5.2	11.9	640	25.0	16.4	0.66	1.47	30.0	17.0	640	29.8	2.13	22.5	113.0	4.1
	6.0	5.2	11.9	850	26.0	18.6	0.72	1.53	31.2	17.0	850	30.5	1.91	24.0	103.0	4.7
80	3.0	1.3	3.0	640	22.9	15.7	0.69	1.87	29.3	12.2	640	30.2	2.14	22.9	114.0	4.1
	3.0	1.3	3.0	850	23.8	17.8	0.75	1.95	30.5	12.2	850	31.0	1.92	24.4	104.0	4.7
	4.5	2.6	6.1	640	23.4	15.8	0.68	1.72	29.3	13.6	640	31.4	2.17	24.0	116.0	4.2
	4.5	2.6	6.1	850	24.4	17.9	0.73	1.80	30.5	13.5	850	32.4	1.95	25.7	105.0	4.9
	6.0	4.9	11.3	640	23.8	16.0	0.67	1.66	29.5	14.3	640	32.1	2.19	24.6	117.0	4.3
	6.0	4.9	11.3	850	24.8	18.1	0.73	1.73	30.7	14.3	850	33.0	1.96	26.3	106.0	4.9
85	3.0	1.3	2.9	640	22.2	15.5	0.70	1.99	29.0	11.1	640	31.2	2.17	23.8	116.0	4.2
	3.0	1.3	2.9	850	23.1	17.5	0.76	2.08	30.2	11.1	850	32.1	1.94	25.5	105.0	4.8
	4.5	2.6	5.9	640	22.8	15.6	0.68	1.84	29.1	12.4	640	32.5	2.20	25.0	118.0	4.3
	4.5	2.6	5.9	850	23.7	17.6	0.74	1.91	30.2	12.4	850	33.4	1.97	26.7	107.0	5.0
	6.0	4.8	11.0	640	23.2	15.7	0.68	1.76	29.2	13.2	640	33.0	2.21	25.5	119.0	4.4
	6.0	4.8	11.0	850	24.1	17.8	0.74	1.84	30.4	13.1	850	34.0	1.98	27.2	108.0	5.0
90	3.0	1.2	2.8	640	21.6	15.3	0.71	2.12	28.8	10.2	640	32.3	2.19	24.8	117.0	4.3
	3.0	1.2	2.8	850	22.4	17.3	0.77	2.21	29.9	10.1	850	33.2	1.97	26.5	107.0	4.9
	4.5	2.5	5.8	640	22.2	15.4	0.69	1.95	28.9	11.4	640	33.5	2.22	25.9	120.0	4.4
	4.5	2.5	5.8	850	23.1	17.4	0.75	2.03	30.0	11.4	850	34.4	1.99	27.6	108.0	5.1
	6.0	4.7	10.7	640	22.5	15.4	0.68	1.87	28.9	12.0	640	34.0	2.24	26.4	121.0	4.5
	6.0	4.7	10.7	850	23.4	17.5	0.75	1.95	30.1	12.0	850	35.1	2.01	28.2	109.0	5.1
100	3.0	1.2	2.7	640	20.2	14.8	0.73	2.40	28.4	8.4	Operation not recommended					
	3.0	1.2	2.7	850	21.0	16.8	0.80	2.50	29.5	8.4						
	4.5	2.4	5.5	640	20.8	14.9	0.72	2.21	28.3	9.4						
	4.5	2.4	5.5	850	21.6	16.9	0.78	2.30	29.5	9.4						
	6.0	4.5	10.3	640	21.1	15.0	0.71	2.12	28.3	9.9						
	6.0	4.5	10.3	850	22.0	17.0	0.77	2.21	29.5	9.9						
110	3.0	1.1	2.5	640	18.8	14.4	0.77	2.73	28.1	6.9	Operation not recommended					
	3.0	1.1	2.5	850	19.5	16.3	0.84	2.84	29.2	6.9						
	4.5	2.3	5.3	640	19.3	14.4	0.75	2.51	27.9	7.7						
	4.5	2.3	5.3	850	20.1	16.3	0.81	2.62	29.0	7.7						
	6.0	4.3	9.9	640	19.7	14.5	0.74	2.41	27.9	8.2						
	6.0	4.3	9.9	850	20.5	16.4	0.80	2.51	29.1	8.2						
120	3.0	1.0	2.4	640	17.1	13.9	0.81	3.09	27.6	5.5	Operation not recommended					
	3.0	1.0	2.4	850	17.8	15.7	0.88	3.22	28.8	5.5						
	4.5	2.2	5.1	640	17.8	14.0	0.79	2.85	27.5	6.2						
	4.5	2.2	5.1	850	18.6	15.8	0.85	2.97	28.7	6.3						
	6.0	4.2	9.6	640	18.3	14.1	0.77	2.74	27.7	6.7						
	6.0	4.2	9.6	850	19.1	16.0	0.84	2.85	28.8	6.7						

Interpolation is permissible; extrapolation is not.
 All entering air conditions are 80°F DB and 67°F WB in cooling, and 70°F DB in heating.
 AHRI/ISO certified conditions are 80.6°F DB and 66.2°F WB in cooling and 68°F DB in heating.
 Table does not reflect fan or pump power corrections for AHRI/ISO conditions.
 All performance is based upon the lower voltage of dual voltage rated units.
 Performance stated is at the rated power supply; performance may vary as the power supply varies from the rated.
 Operation below 40°F EWT is based upon a 15% methanol antifreeze solution.
 Operation below 60°F EWT requires optional insulated water/refrigerant circuit.
 See performance correction tables for operating conditions other than those listed above.
 See Performance Data Selection Notes for operation in the shaded areas.

Performance Data – HBH/V 030 (PSC Blower)

1,000 CFM Nominal (Rated) Airflow

Performance capacities shown in thousands of Btuh

EWT °F	GPM	WPD		Cooling - EAT 80/67°F							Heating - EAT 70°F					
		PSI	FT	Airflow CFM	TC	SC	Sens/Tot Ratio	kW	HR	EER	Airflow CFM	HC	kW	HE	LAT	COP
20	7.5	5.0	11.6	Operation not recommended							750	20.0	2.31	12.6	95	2.53
	7.5	5.0	11.6								1000	20.4	2.08	13.4	89	2.89
30	3.8	1.3	2.9	750	33.3	20.3	0.61	1.38	38.0	24.0	750	21.6	2.37	14.0	97	2.67
	3.8	1.3	2.9	1000	34.7	22.9	0.66	1.44	39.5	24.0	1000	22.1	2.13	14.9	90	3.04
	5.6	2.3	5.4	750	33.5	20.2	0.60	1.31	37.9	25.7	750	22.5	2.40	14.7	98	2.75
	5.6	2.3	5.4	1000	34.9	22.8	0.65	1.36	39.5	25.7	1000	23.0	2.15	15.7	91	3.13
	7.5	4.2	9.7	750	33.6	20.0	0.60	1.27	37.9	26.5	750	22.9	2.41	15.1	98	2.79
	7.5	4.2	9.7	1000	35.0	22.7	0.65	1.32	39.4	26.5	1000	23.5	2.16	16.2	92	3.18
40	3.8	1.0	2.4	750	32.6	20.2	0.62	1.51	37.7	21.6	750	24.7	2.45	16.7	100	2.95
	3.8	1.0	2.4	1000	34.0	22.8	0.67	1.57	39.3	21.6	1000	25.3	2.20	17.8	93	3.36
	5.6	2.0	4.7	750	33.1	20.3	0.61	1.42	37.9	23.3	750	25.7	2.48	17.6	102	3.04
	5.6	2.0	4.7	1000	34.5	22.9	0.67	1.48	39.5	23.3	1000	26.4	2.23	18.8	94	3.47
	7.5	3.7	8.6	750	33.7	20.5	0.61	1.38	38.3	24.4	750	26.3	2.49	18.1	102	3.10
	7.5	3.7	8.6	1000	35.1	23.2	0.66	1.44	39.9	24.4	1000	26.9	2.24	19.4	95	3.53
50	3.8	0.9	2.1	750	31.6	19.9	0.63	1.65	37.2	19.2	750	27.8	2.52	19.5	104	3.24
	3.8	0.9	2.1	1000	32.9	22.5	0.68	1.72	38.8	19.2	1000	28.5	2.26	20.8	96	3.69
	5.6	1.8	4.2	750	32.3	20.1	0.62	1.55	37.6	20.9	750	29.1	2.55	20.6	106	3.35
	5.6	1.8	4.2	1000	33.7	22.8	0.68	1.61	39.1	20.9	1000	29.8	2.29	22.0	98	3.82
	7.5	3.4	7.8	750	32.6	20.2	0.62	1.50	37.7	21.7	750	29.8	2.56	21.3	107	3.41
	7.5	3.4	7.8	1000	34.0	22.9	0.67	1.57	39.3	21.7	1000	30.5	2.30	22.7	98	3.89
60	3.8	0.8	1.8	750	30.4	19.4	0.64	1.81	36.6	16.8	750	31.0	2.58	22.4	108	3.52
	3.8	0.8	1.8	1000	31.7	21.9	0.69	1.89	38.1	16.8	1000	31.8	2.32	23.9	99	4.02
	5.6	1.7	3.8	750	31.1	19.6	0.63	1.70	36.9	18.3	750	32.5	2.61	23.7	110	3.65
	5.6	1.7	3.8	1000	32.4	22.2	0.69	1.77	38.4	18.3	1000	33.3	2.34	25.3	101	4.16
	7.5	3.1	7.2	750	31.4	19.7	0.63	1.65	37.0	19.0	750	33.3	2.63	24.4	111	3.71
	7.5	3.1	7.2	1000	32.7	22.3	0.68	1.71	38.5	19.1	1000	34.1	2.36	26.0	102	4.24
70	3.8	0.7	1.6	750	29.0	18.8	0.65	2.00	35.8	14.5	750	34.2	2.64	25.2	112	3.79
	3.8	0.7	1.6	1000	30.2	21.2	0.70	2.08	37.3	14.5	1000	35.1	2.37	26.9	102	4.33
	5.6	1.5	3.6	750	30.0	19.2	0.64	1.87	36.3	16.0	750	35.8	2.68	26.7	114	3.92
	5.6	1.5	3.6	1000	31.2	21.7	0.70	1.95	37.8	16.0	1000	36.7	2.40	28.5	104	4.47
	7.5	2.9	6.7	750	30.4	19.4	0.64	1.81	36.6	16.8	750	36.7	2.70	27.4	115	3.99
	7.5	2.9	6.7	1000	31.7	21.9	0.69	1.89	38.1	16.8	1000	37.6	2.42	29.3	105	4.55
80	3.8	0.7	1.5	750	27.7	18.3	0.66	2.21	35.3	12.5	750	37.3	2.71	28.0	116	4.04
	3.8	0.7	1.5	1000	28.8	20.7	0.72	2.30	36.7	12.5	1000	38.2	2.43	29.9	105	4.60
	5.6	1.4	3.3	750	28.5	18.5	0.65	2.07	35.5	13.7	750	39.0	2.75	29.5	118	4.15
	5.6	1.4	3.3	1000	29.6	21.0	0.71	2.16	37.0	13.7	1000	40.0	2.47	31.5	107	4.74
	7.5	2.7	6.3	750	29.0	18.7	0.65	2.00	35.8	14.5	750	40.2	2.78	30.6	120	4.24
	7.5	2.7	6.3	1000	30.2	21.2	0.70	2.08	37.3	14.5	1000	41.2	2.50	32.6	108	4.84
85	3.8	0.6	1.4	750	26.7	17.8	0.67	2.34	34.7	11.5	750	38.8	2.75	29.3	118	4.14
	3.8	0.6	1.4	1000	27.8	20.1	0.72	2.43	36.1	11.5	1000	39.8	2.5	31.3	107	4.72
	5.6	1.4	3.2	750	27.6	18.2	0.66	2.18	35.1	12.7	750	40.5	2.8	30.8	120	4.24
	5.6	1.4	3.2	1000	28.8	20.6	0.71	2.27	36.5	12.7	1000	41.5	2.5	32.9	108	4.84
	7.5	2.7	6.2	750	28.2	18.4	0.65	2.11	35.4	13.4	750	41.6	2.8	31.7	121	4.30
	7.5	2.7	6.2	1000	29.3	20.8	0.71	2.20	36.8	13.4	1000	42.6	2.5	33.9	109	4.91
90	3.8	0.6	1.4	750	25.7	17.3	0.67	2.46	34.1	10.5	750	40.3	2.79	30.6	120	4.23
	3.8	0.6	1.4	1000	26.8	19.6	0.73	2.56	35.5	10.5	1000	41.3	2.51	32.7	108	4.83
	5.6	1.4	3.1	750	26.8	17.8	0.66	2.30	34.7	11.7	750	42.0	2.85	32.1	122	4.33
	5.6	1.4	3.1	1000	27.9	20.1	0.72	2.39	36.1	11.7	1000	43.0	2.56	34.3	110	4.93
	7.5	2.6	6.0	750	27.3	18.0	0.66	2.22	34.9	12.3	750	42.9	2.88	32.9	123	4.36
	7.5	2.6	6.0	1000	28.5	20.4	0.72	2.31	36.4	12.3	1000	44.0	2.59	35.1	111	4.98
100	3.8	0.6	1.3	750	24.0	16.6	0.69	2.74	33.3	8.7	Operation not recommended					
	3.8	0.6	1.3	1000	24.9	18.8	0.75	2.85	34.7	8.7						
	5.6	1.3	3.0	750	25.1	17.0	0.68	2.56	33.8	9.8						
	5.6	1.3	3.0	1000	26.1	19.3	0.74	2.67	35.2	9.8						
	7.5	2.5	5.7	750	25.6	17.3	0.67	2.48	34.1	10.3						
	7.5	2.5	5.7	1000	26.7	19.6	0.73	2.58	35.5	10.3						
110	3.8	0.5	1.2	750	22.5	16.1	0.72	3.07	33.0	7.4	Operation not recommended					
	3.8	0.5	1.2	1000	23.5	18.2	0.78	3.19	34.4	7.4						
	5.6	1.2	2.8	750	23.2	16.3	0.70	2.86	33.1	8.1						
	5.6	1.2	2.8	1000	24.2	18.4	0.76	2.98	34.4	8.1						
	7.5	2.4	5.5	750	23.8	16.5	0.69	2.77	33.3	8.6						
	7.5	2.4	5.5	1000	24.8	18.7	0.75	2.88	34.6	8.6						
120	3.8	0.5	1.1	750	20.4	15.2	0.74	3.44	32.2	5.9	Operation not recommended					
	3.8	0.5	1.1	1000	21.2	17.2	0.81	3.58	33.5	5.9						
	5.6	1.2	2.7	750	21.4	15.6	0.73	3.21	32.4	6.7						
	5.6	1.2	2.7	1000	22.3	17.6	0.79	3.34	33.8	6.7						
	7.5	2.3	5.3	750	22.0	15.8	0.72	3.10	32.6	7.1						
	7.5	2.3	5.3	1000	22.9	17.8	0.78	3.23	33.9	7.1						

Interpolation is permissible; extrapolation is not.
 All entering air conditions are 80°F DB and 67°F WB in cooling, and 70°F DB in heating.
 AHRI/ISO certified conditions are 80.6°F DB and 66.2°F WB in cooling and 68°F DB in heating.
 Table does not reflect fan or pump power corrections for AHRI/ISO conditions.
 All performance is based upon the lower voltage of dual voltage rated units.
 Performance stated is at the rated power supply; performance may vary as the power supply varies from the rated.
 Operation below 40°F EWT is based upon a 15% methanol antifreeze solution.
 Operation below 60°F EWT requires optional insulated water/refrigerant circuit.
 See performance correction tables for operating conditions other than those listed above.
 See Performance Data Selection Notes for operation in the shaded areas.

Performance Data – HBH/V 030 (ECM Blower)

875 CFM Nominal (Rated) Airflow

Performance capacities shown in thousands of Btu/h

EWT °F	GPM	WPD		Cooling - EAT 80/67°F							Heating - EAT 70°F					
		PSI	FT	Airflow CFM	TC	SC	Sens/Tot Ratio	kW	HR	EER	Airflow CFM	HC	kW	HE	LAT	COP
20	7.5	5.0	11.6	Operation not recommended							750	20.3	2.25	12.6	92.0	2.6
	7.5	5.0	11.6								1000	20.3	2.02	13.4	87.0	2.9
30	3.8	1.3	2.9	750	33.3	20.3	0.61	1.32	37.8	25.2	750	21.9	2.31	14.0	95.0	2.8
	3.8	1.3	2.9	1000	34.7	22.9	0.66	1.38	39.4	25.1	1000	22.0	2.07	14.9	89.0	3.1
	5.6	2.3	5.4	750	33.5	20.2	0.60	1.25	37.8	26.8	750	22.7	2.34	14.7	96.0	2.8
	5.6	2.3	5.4	1000	34.9	22.8	0.65	1.30	39.3	26.8	1000	22.8	2.09	15.7	90.0	3.2
	7.5	4.2	9.7	750	33.6	20.0	0.60	1.21	37.7	27.7	750	23.1	2.35	15.1	97.0	2.9
	7.5	4.2	9.7	1000	35.0	22.7	0.65	1.26	39.3	27.7	1000	23.4	2.10	16.2	90.0	3.3
40	3.8	1.0	2.4	750	32.6	20.2	0.62	1.45	37.6	22.5	750	24.9	2.39	16.7	99.0	3.0
	3.8	1.0	2.4	1000	34.0	22.8	0.67	1.51	39.2	22.5	1000	25.1	2.14	17.8	92.0	3.4
	5.6	2.0	4.7	750	33.1	20.3	0.61	1.36	37.7	24.3	750	25.9	2.42	17.6	100.0	3.1
	5.6	2.0	4.7	1000	34.5	22.9	0.66	1.42	39.4	24.3	1000	26.2	2.17	18.8	93.0	3.5
	7.5	3.7	8.6	750	33.7	20.5	0.61	1.32	38.2	25.5	750	26.4	2.43	18.1	101.0	3.2
	7.5	3.7	8.6	1000	35.1	23.2	0.66	1.38	39.8	25.4	1000	26.8	2.18	19.4	94.0	3.6
50	3.8	0.9	2.1	750	31.6	19.9	0.63	1.59	37.0	19.9	750	27.9	2.46	19.5	103.0	3.3
	3.8	0.9	2.1	1000	32.9	22.5	0.68	1.66	38.6	19.8	1000	28.3	2.20	20.8	95.0	3.8
	5.6	1.8	4.2	750	32.3	20.1	0.62	1.49	37.4	21.7	750	29.1	2.49	20.6	104.0	3.4
	5.6	1.8	4.2	1000	33.7	22.8	0.68	1.55	39.0	21.7	1000	29.6	2.23	22.0	96.0	3.9
	7.5	3.4	7.8	750	32.6	20.2	0.62	1.44	37.5	22.6	750	29.8	2.50	21.3	105.0	3.5
	7.5	3.4	7.8	1000	34.0	22.9	0.67	1.51	39.2	22.5	1000	30.3	2.24	22.7	97.0	4.0
60	3.8	0.8	1.8	750	30.4	19.4	0.64	1.75	36.4	17.4	750	31.0	2.52	22.4	106.0	3.6
	3.8	0.8	1.8	1000	31.7	21.9	0.69	1.83	37.9	17.3	1000	31.6	2.26	23.9	98.0	4.1
	5.6	1.7	3.8	750	31.1	19.6	0.63	1.64	36.7	18.9	750	32.4	2.55	23.7	108.0	3.7
	5.6	1.7	3.8	1000	32.4	22.2	0.69	1.71	38.2	18.9	1000	33.1	2.28	25.3	99.0	4.2
	7.5	3.1	7.2	750	31.4	19.7	0.63	1.59	36.8	19.7	750	33.2	2.57	24.4	109.0	3.8
	7.5	3.1	7.2	1000	32.7	22.3	0.68	1.65	38.3	19.8	1000	33.9	2.30	26.0	100.0	4.3
70	3.8	0.7	1.6	750	29.0	18.8	0.65	1.94	35.6	14.9	750	34.0	2.58	25.2	110.0	3.9
	3.8	0.7	1.6	1000	30.2	21.2	0.70	2.02	37.1	14.9	1000	34.8	2.31	26.9	101.0	4.4
	5.6	1.5	3.6	750	30.0	19.2	0.64	1.81	36.2	16.6	750	35.6	2.62	26.7	112.0	4.0
	5.6	1.5	3.6	1000	31.2	21.7	0.70	1.89	37.7	16.5	1000	36.5	2.34	28.5	102.0	4.6
	7.5	2.9	6.7	750	30.4	19.4	0.64	1.75	36.4	17.4	750	36.4	2.64	27.4	113.0	4.0
	7.5	2.9	6.7	1000	31.7	21.9	0.69	1.83	37.9	17.3	1000	37.4	2.36	29.3	103.0	4.6
80	3.8	0.7	1.5	750	27.7	18.3	0.66	2.15	35.0	12.9	750	37.0	2.65	28.0	114.0	4.1
	3.8	0.7	1.5	1000	28.8	20.7	0.72	2.24	36.4	12.8	1000	38.0	2.37	29.9	104.0	4.7
	5.6	1.4	3.3	750	28.5	18.5	0.65	2.01	35.4	14.2	750	38.7	2.69	29.5	116.0	4.2
	5.6	1.4	3.3	1000	29.6	21.0	0.71	2.10	36.8	14.1	1000	39.7	2.41	31.5	105.0	4.8
	7.5	2.7	6.3	750	29.0	18.7	0.64	1.94	35.6	14.9	750	39.9	2.72	30.6	117.0	4.3
	7.5	2.7	6.3	1000	30.2	21.2	0.70	2.02	37.1	14.9	1000	40.9	2.44	32.6	106.0	4.9
85	3.8	0.6	1.4	750	26.7	17.8	0.67	2.28	34.5	11.7	750	38.5	2.69	29.3	116.0	4.2
	3.8	0.6	1.4	1000	27.8	20.1	0.72	2.37	35.9	11.7	1000	39.6	2.44	31.3	105.0	4.8
	5.6	1.4	3.2	750	27.6	18.2	0.66	2.12	34.8	13.0	750	40.2	2.74	30.8	118.0	4.3
	5.6	1.4	3.2	1000	28.8	20.6	0.72	2.21	36.3	13.0	1000	41.2	2.44	32.9	107.0	4.9
	7.5	2.7	6.2	750	28.2	18.4	0.65	2.05	35.2	13.7	750	41.1	2.74	31.7	119.0	4.4
	7.5	2.7	6.2	1000	29.3	20.8	0.71	2.14	36.6	13.7	1000	42.2	2.44	33.9	108.0	5.1
90	3.8	0.6	1.4	750	25.7	17.3	0.67	2.40	33.9	10.7	750	39.9	2.73	30.6	117.0	4.3
	3.8	0.6	1.4	1000	26.8	19.6	0.73	2.50	35.3	10.7	1000	41.1	2.45	32.7	107.0	4.9
	5.6	1.4	3.1	750	26.8	17.8	0.66	2.24	34.4	12.0	750	41.6	2.79	32.1	120.0	4.4
	5.6	1.4	3.1	1000	27.9	20.1	0.72	2.33	35.9	12.0	1000	42.8	2.50	34.3	108.0	5.0
	7.5	2.6	6.0	750	27.3	18.0	0.66	2.16	34.7	12.6	750	42.5	2.82	32.9	121.0	4.4
	7.5	2.6	6.0	1000	28.5	20.4	0.72	2.25	36.2	12.7	1000	43.7	2.53	35.1	109.0	5.1
100	3.8	0.6	1.3	750	24.0	16.6	0.69	2.68	33.1	8.9	Operation not recommended					
	3.8	0.6	1.3	1000	24.9	18.8	0.76	2.79	34.4	8.9						
	5.6	1.3	3.0	750	25.1	17.0	0.68	2.50	33.6	10.0						
	5.6	1.3	3.0	1000	26.1	19.3	0.74	2.61	35.0	10.0						
	7.5	2.5	5.7	750	25.6	17.3	0.68	2.42	33.9	10.6						
	7.5	2.5	5.7	1000	26.7	19.6	0.73	2.52	35.3	10.6						
110	3.8	0.5	1.2	750	22.5	16.1	0.72	3.01	32.8	7.5	Operation not recommended					
	3.8	0.5	1.2	1000	23.5	18.2	0.77	3.13	34.2	7.5						
	5.6	1.2	2.8	750	23.2	16.3	0.70	2.80	32.8	8.3						
	5.6	1.2	2.8	1000	24.2	18.4	0.76	2.92	34.2	8.3						
	7.5	2.4	5.5	750	23.8	16.5	0.69	2.71	33.1	8.8						
	7.5	2.4	5.5	1000	24.8	18.7	0.75	2.82	34.4	8.8						
120	3.8	0.5	1.1	750	20.4	15.2	0.75	3.38	31.9	6.0	Operation not recommended					
	3.8	0.5	1.1	1000	21.2	17.2	0.81	3.52	33.2	6.0						
	5.6	1.2	2.7	750	21.4	15.6	0.73	3.15	32.2	6.8						
	5.6	1.2	2.7	1000	22.3	17.6	0.79	3.28	33.5	6.8						
	7.5	2.3	5.3	750	22.0	15.8	0.72	3.04	32.4	7.2						
	7.5	2.3	5.3	1000	22.9	17.8	0.78	3.17	33.7	7.2						

Interpolation is permissible; extrapolation is not.
 All entering air conditions are 80°F DB and 67°F WB in cooling, and 70°F DB in heating.
 AHRI/ISO certified conditions are 80.6°F DB and 66.2°F WB in cooling and 68°F DB in heating.
 Table does not reflect fan or pump power corrections for AHRI/ISO conditions.
 All performance is based upon the lower voltage of dual voltage rated units.
 Performance stated is at the rated power supply; performance may vary as the power supply varies from the rated.
 Operation below 40°F EWT is based upon a 15% methanol antifreeze solution.
 Operation below 60°F EWT requires optional insulated water/refrigerant circuit.
 See performance correction tables for operating conditions other than those listed above.
 See Performance Data Selection Notes for operation in the shaded areas.

Performance Data – HBH/V 036 (PSC Blower)

1,200 CFM Nominal (Rated) Airflow

Performance capacities shown in thousands of Btuh

EWT °F	GPM	WPD		Cooling - EAT 80/67°F							Heating - EAT 70°F					
		PSI	FT	Airflow CFM	TC	SC	Sens/Tot Ratio	kW	HR	EER	Airflow CFM	HC	kW	HE	LAT	COP
20	9.0	6.4	14.8	Operation not recommended							860	22.6	2.67	14.1	94	2.49
	9.0	6.4	14.8								1150	23.2	2.39	15.1	89	2.84
30	4.5	1.8	4.3	860	39.9	24.2	0.61	1.67	45.6	23.8	860	25.6	2.80	16.6	98	2.68
	4.5	1.8	4.3	1150	41.5	27.4	0.66	1.74	47.4	23.8	1150	26.2	2.51	17.7	91	3.06
	6.8	3.1	7.1	860	40.1	24.3	0.61	1.62	45.5	24.7	860	26.8	2.85	17.6	99	2.76
	6.8	3.1	7.1	1150	41.7	27.5	0.66	1.69	47.4	24.7	1150	27.5	2.56	18.8	92	3.15
	9.0	5.4	12.5	860	40.0	24.3	0.61	1.60	45.5	25.0	860	27.5	2.88	18.2	100	2.80
	9.0	5.4	12.5	1150	41.7	27.5	0.66	1.67	47.3	25.0	1150	28.2	2.59	19.4	93	3.19
40	4.5	1.6	3.6	860	39.2	24.0	0.61	1.80	45.3	21.8	860	30.1	2.98	20.3	102	2.95
	4.5	1.6	3.6	1150	40.8	27.2	0.67	1.87	47.1	21.8	1150	30.8	2.68	21.7	95	3.37
	6.8	2.7	6.2	860	39.7	24.2	0.61	1.71	45.5	23.3	860	31.6	3.05	21.6	104	3.04
	6.8	2.7	6.2	1150	41.4	27.4	0.66	1.78	47.4	23.3	1150	32.4	2.74	23.1	96	3.47
	9.0	4.8	11.1	860	39.9	24.3	0.61	1.67	45.6	23.9	860	32.4	3.08	22.3	105	3.09
	9.0	4.8	11.1	1150	41.6	27.4	0.66	1.74	47.4	23.9	1150	33.2	2.77	23.8	97	3.52
50	4.5	1.4	3.2	860	38.0	23.6	0.62	1.98	44.7	19.2	860	34.5	3.16	24.1	107	3.20
	4.5	1.4	3.2	1150	39.5	26.7	0.68	2.06	46.5	19.2	1150	35.4	2.84	25.7	98	3.65
	6.8	2.4	5.6	860	38.8	23.9	0.62	1.85	45.1	21.0	860	36.3	3.23	25.6	109	3.30
	6.8	2.4	5.6	1150	40.4	27.0	0.67	1.92	47.0	21.0	1150	37.2	2.90	27.3	100	3.76
	9.0	4.4	10.1	860	39.2	24.0	0.61	1.79	45.3	21.9	860	37.3	3.27	26.4	110	3.35
	9.0	4.4	10.1	1150	40.8	27.2	0.67	1.87	47.2	21.9	1150	38.2	2.93	28.2	101	3.82
60	4.5	1.3	2.9	860	36.1	22.9	0.63	2.20	43.6	16.4	860	38.9	3.32	27.8	112	3.43
	4.5	1.3	2.9	1150	37.6	25.9	0.69	2.29	45.4	16.4	1150	39.8	2.99	29.7	102	3.91
	6.8	2.3	5.2	860	37.5	23.5	0.63	2.04	44.4	18.4	860	40.9	3.40	29.5	114	3.53
	6.8	2.3	5.2	1150	39.1	26.5	0.68	2.13	46.3	18.4	1150	41.9	3.05	31.5	104	4.02
	9.0	4.0	9.3	860	38.0	23.6	0.62	1.97	44.7	19.3	860	42.0	3.44	30.4	115	3.58
	9.0	4.0	9.3	1150	39.6	26.7	0.68	2.05	46.5	19.3	1150	43.0	3.09	32.5	105	4.08
70	4.5	1.2	2.7	860	34.6	22.5	0.65	2.46	42.9	14.0	860	43.1	3.47	31.4	116	3.64
	4.5	1.2	2.7	1150	36.0	25.5	0.71	2.56	44.7	14.0	1150	44.1	3.12	33.5	106	4.15
	6.8	2.1	4.9	860	35.8	22.9	0.64	2.28	43.6	15.7	860	45.2	3.55	33.2	119	3.74
	6.8	2.1	4.9	1150	37.3	25.9	0.70	2.38	45.4	15.7	1150	46.3	3.19	35.4	107	4.26
	9.0	3.8	8.7	860	36.4	23.1	0.63	2.20	43.9	16.6	860	46.4	3.59	34.2	120	3.79
	9.0	3.8	8.7	1150	37.9	26.1	0.69	2.29	45.7	16.6	1150	47.5	3.22	36.5	108	4.32
80	4.5	1.1	2.5	860	32.5	21.8	0.67	2.76	41.9	11.8	860	47.0	3.61	34.8	121	3.82
	4.5	1.1	2.5	1150	33.8	24.7	0.73	2.88	43.7	11.8	1150	48.2	3.24	37.1	109	4.36
	6.8	2.0	4.6	860	33.9	22.3	0.66	2.56	42.6	13.2	860	49.2	3.68	36.6	123	3.92
	6.8	2.0	4.6	1150	35.3	25.2	0.72	2.67	44.4	13.2	1150	50.4	3.30	39.1	111	4.47
	9.0	3.6	8.3	860	34.5	22.5	0.65	2.47	42.9	14.0	860	50.3	3.71	37.6	124	3.97
	9.0	3.6	8.3	1150	35.9	25.5	0.71	2.57	44.7	14.0	1150	51.5	3.34	40.1	111	4.53
85	4.5	1.0	2.4	860	31.5	21.5	0.68	2.9	41.5	10.8	860	48.8	3.67	36.3	123	3.90
	4.5	1.0	2.4	1150	32.8	24.4	0.74	3.05	43.3	10.8	1150	50.0	3.29	38.8	110	4.45
	6.8	1.9	4.4	860	32.8	21.9	0.67	2.72	42.1	12.1	860	50.9	3.73	38.1	125	4.00
	6.8	1.9	4.4	1150	34.1	24.8	0.73	2.84	43.8	12.1	1150	52.2	3.35	40.7	112	4.56
	9.0	3.5	8.1	860	33.4	22.1	0.66	2.62	42.3	12.8	860	52.0	3.76	39.0	126	4.05
	9.0	3.5	8.1	1150	34.7	25.0	0.72	2.73	44.1	12.8	1150	53.2	3.38	41.7	113	4.62
90	4.5	1.0	2.3	860	30.5	21.2	0.70	3.10	41.1	9.8	860	50.6	3.72	37.9	125	3.99
	4.5	1.0	2.3	1150	31.8	24.0	0.76	3.23	42.8	9.8	1150	51.9	3.34	40.4	112	4.54
	6.8	1.9	4.3	860	31.7	21.6	0.68	2.88	41.6	11.0	860	52.7	3.79	39.6	127	4.08
	6.8	1.9	4.3	1150	33.0	24.4	0.74	3.00	43.3	11.0	1150	54.0	3.40	42.3	113	4.65
	9.0	3.4	7.9	860	32.2	21.7	0.67	2.78	41.7	11.6	860	53.7	3.82	40.5	128	4.12
	9.0	3.4	7.9	1150	33.5	24.5	0.73	2.89	43.4	11.6	1150	55.0	3.43	43.2	114	4.70
100	4.5	0.9	2.2	860	28.3	20.5	0.72	3.47	40.2	8.1	Operation not recommended					
	4.5	0.9	2.2	1150	29.5	23.1	0.79	3.62	41.9	8.2						
	6.8	1.8	4.1	860	29.5	20.8	0.71	3.24	40.6	9.1						
	6.8	1.8	4.1	1150	30.7	23.5	0.77	3.37	42.2	9.1						
	9.0	3.3	7.5	860	30.1	21.0	0.70	3.13	40.8	9.6						
	9.0	3.3	7.5	1150	31.3	23.7	0.76	3.25	42.5	9.6						
110	4.5	0.9	2.1	860	26.2	19.8	0.75	3.88	39.5	6.8	Operation not recommended					
	4.5	0.9	2.1	1150	27.3	22.4	0.82	4.04	41.1	6.8						
	6.8	1.7	4.0	860	27.2	20.0	0.73	3.63	39.7	7.5						
	6.8	1.7	4.0	1150	28.4	22.6	0.80	3.78	41.3	7.5						
	9.0	3.1	7.2	860	27.6	20.0	0.72	3.51	39.6	7.9						
	9.0	3.1	7.2	1150	28.8	22.7	0.79	3.65	41.3	7.9						
120	4.5	0.9	2.0	860	24.1	19.0	0.79	4.31	38.9	5.6	Operation not recommended					
	4.5	0.9	2.0	1150	25.1	21.4	0.86	4.49	40.4	5.6						
	6.8	1.6	3.8	860	25.1	19.2	0.77	4.05	39.0	6.2						
	6.8	1.6	3.8	1150	26.1	21.8	0.83	4.21	40.6	6.2						
	9.0	3.0	7.0	860	25.4	19.2	0.76	3.92	38.9	6.5						
	9.0	3.0	7.0	1150	26.5	21.8	0.82	4.08	40.5	6.5						

Interpolation is permissible; extrapolation is not.
 All entering air conditions are 80°F DB and 67°F WB in cooling, and 70°F DB in heating.
 AHRI/ISO certified conditions are 80.6°F DB and 66.2°F WB in cooling and 68°F DB in heating.
 Table does not reflect fan or pump power corrections for AHRI/ISO conditions.
 All performance is based upon the lower voltage of dual voltage rated units.
 Performance stated is at the rated power supply; performance may vary as the power supply varies from the rated.
 Operation below 40°F EWT is based upon a 15% methanol antifreeze solution.
 Operation below 60°F EWT requires optional insulated water/refrigerant circuit.
 See performance correction tables for operating conditions other than those listed above.
 See Performance Data Selection Notes for operation in the shaded areas.

Performance Data – HBH/V 036 (ECM Blower)

1125 CFM Nominal (Rated) Airflow

Performance capacities shown in thousands of Btu/h

EWT °F	GPM	WPD		Cooling - EAT 80/67°F							Heating - EAT 70°F					
		PSI	FT	Airflow CFM	TC	SC	Sens/Tot Ratio	kW	HR	EER	Airflow CFM	HC	kW	HE	LAT	COP
20	9.0	6.4	14.8	Operation not recommended							860	23.1	2.63	14.1	92.0	2.6
	9.0	6.4	14.8								1150	23.1	2.35	15.1	87.0	2.9
30	4.5	1.8	4.3	860	39.9	24.2	0.61	1.63	45.5	24.4	860	26.0	2.76	16.6	95.0	2.8
	4.5	1.8	4.3	1150	41.5	27.4	0.66	1.70	47.3	24.4	1150	26.1	2.47	17.7	89.0	3.1
	6.8	3.1	7.1	860	40.1	24.3	0.61	1.58	45.5	25.3	860	27.2	2.81	17.6	96.0	2.8
	6.8	3.1	7.1	1150	41.7	27.5	0.66	1.65	47.3	25.2	1150	27.4	2.52	18.8	90.0	3.2
	9.0	5.4	12.5	860	40.0	24.3	0.61	1.56	45.3	25.6	860	27.9	2.84	18.2	97.0	2.9
	9.0	5.4	12.5	1150	41.7	27.5	0.66	1.63	47.3	25.5	1150	28.1	2.55	19.4	90.0	3.2
40	4.5	1.6	3.6	860	39.2	24.0	0.61	1.76	45.2	22.2	860	30.3	2.94	20.3	99.0	3.0
	4.5	1.6	3.6	1150	40.8	27.2	0.67	1.83	47.1	22.3	1150	30.7	2.64	21.7	92.0	3.4
	6.8	2.7	6.2	860	39.7	24.2	0.61	1.67	45.4	23.7	860	31.9	3.01	21.6	100.0	3.1
	6.8	2.7	6.2	1150	41.4	27.4	0.66	1.74	47.3	23.8	1150	32.3	2.70	23.1	93.0	3.5
	9.0	4.8	11.1	860	39.9	24.3	0.61	1.63	45.5	24.4	860	32.7	3.04	22.3	101.0	3.1
	9.0	4.8	11.1	1150	41.6	27.4	0.66	1.70	47.4	24.4	1150	33.1	2.73	23.8	94.0	3.6
50	4.5	1.4	3.2	860	38.0	23.6	0.62	1.94	44.6	19.6	860	34.8	3.12	24.1	103.0	3.3
	4.5	1.4	3.2	1150	39.5	26.7	0.68	2.02	46.4	19.5	1150	35.3	2.80	25.7	95.0	3.7
	6.8	2.4	5.6	860	38.8	23.9	0.62	1.81	45.0	21.4	860	36.5	3.19	25.6	104.0	3.4
	6.8	2.4	5.6	1150	40.4	27.0	0.67	1.88	46.8	21.5	1150	37.1	2.86	27.3	96.0	3.8
	9.0	4.4	10.1	860	39.2	24.0	0.61	1.75	45.2	22.4	860	37.4	3.23	26.4	105.0	3.4
	9.0	4.4	10.1	1150	40.8	27.2	0.67	1.83	47.1	22.3	1150	38.1	2.89	28.2	97.0	3.9
60	4.5	1.3	2.9	860	36.1	22.9	0.63	2.16	43.5	16.7	860	39.0	3.28	27.8	106.0	3.5
	4.5	1.3	2.9	1150	37.6	25.9	0.69	2.25	45.3	16.7	1150	39.8	2.95	29.7	98.0	3.9
	6.8	2.3	5.2	860	37.5	23.5	0.63	2.00	44.3	18.7	860	41.0	3.36	29.5	108.0	3.6
	6.8	2.3	5.2	1150	39.1	26.5	0.68	2.09	46.2	18.7	1150	41.8	3.01	31.5	99.0	4.1
	9.0	4.0	9.3	860	38.0	23.6	0.62	1.93	44.6	19.7	860	42.0	3.40	30.4	109.0	3.6
	9.0	4.0	9.3	1150	39.6	26.7	0.67	2.01	46.5	19.7	1150	42.9	3.05	32.5	100.0	4.1
70	4.5	1.2	2.7	860	34.6	22.5	0.65	2.42	42.9	14.3	860	43.1	3.43	31.4	110.0	3.7
	4.5	1.2	2.7	1150	36.0	25.5	0.71	2.52	44.6	14.3	1150	44.0	3.08	33.5	101.0	4.2
	6.8	2.1	4.9	860	35.8	22.9	0.64	2.24	43.5	16.0	860	45.2	3.51	33.2	112.0	3.8
	6.8	2.1	4.9	1150	37.3	25.9	0.69	2.34	45.3	15.9	1150	46.2	3.15	35.4	102.0	4.3
	9.0	3.8	8.7	860	36.4	23.1	0.63	2.16	43.8	16.8	860	46.3	3.55	34.2	113.0	3.8
	9.0	3.8	8.7	1150	37.9	26.1	0.69	2.25	45.6	16.8	1150	47.4	3.18	36.5	103.0	4.4
80	4.5	1.1	2.5	860	32.5	21.8	0.67	2.72	41.8	11.9	860	47.0	3.57	34.8	114.0	3.9
	4.5	1.1	2.5	1150	33.8	24.7	0.73	2.84	43.5	11.9	1150	48.0	3.20	37.1	104.0	4.4
	6.8	2.0	4.6	860	33.9	22.3	0.66	2.52	42.5	13.4	860	49.0	3.64	36.6	116.0	3.9
	6.8	2.0	4.6	1150	35.3	25.2	0.71	2.63	44.3	13.4	1150	50.2	3.26	39.1	105.0	4.5
	9.0	3.6	8.3	860	34.5	22.5	0.65	2.43	42.8	14.2	860	50.1	3.67	37.6	117.0	4.0
	9.0	3.6	8.3	1150	35.9	25.5	0.71	2.53	44.5	14.2	1150	51.4	3.30	40.1	106.0	4.6
85	4.5	1.0	2.4	860	31.5	21.5	0.68	2.86	41.3	11.0	860	48.7	3.63	36.3	116.0	3.9
	4.5	1.0	2.4	1150	32.8	24.4	0.74	3.01	43.1	10.9	1150	49.9	3.25	38.8	105.0	4.5
	6.8	1.9	4.4	860	32.8	21.9	0.67	2.68	42.0	12.2	860	50.7	3.69	38.1	118.0	4.0
	6.8	1.9	4.4	1150	34.1	24.8	0.73	2.80	43.7	12.2	1150	52.0	3.31	40.7	107.0	4.6
	9.0	3.5	8.1	860	33.4	22.1	0.66	2.58	42.2	12.9	860	51.7	3.72	39.0	119.0	4.1
	9.0	3.5	8.1	1150	34.7	25.0	0.72	2.69	43.9	12.9	1150	53.1	3.34	41.7	108.0	4.7
90	4.5	1.0	2.3	860	30.5	21.2	0.70	3.06	40.9	10.0	860	50.5	3.68	37.9	117.0	4.0
	4.5	1.0	2.3	1150	31.8	24.0	0.75	3.19	42.7	10.0	1150	51.7	3.30	40.4	107.0	4.6
	6.8	1.9	4.3	860	31.7	21.6	0.68	2.84	41.4	11.2	860	52.4	3.75	39.6	120.0	4.1
	6.8	1.9	4.3	1150	33.0	24.4	0.74	2.96	43.1	11.1	1150	53.8	3.36	42.3	108.0	4.7
	9.0	3.4	7.9	860	32.2	21.7	0.67	2.74	41.6	11.7	860	53.4	3.78	40.5	121.0	4.1
	9.0	3.4	7.9	1150	33.5	24.5	0.73	2.85	43.2	11.7	1150	54.8	3.39	43.2	109.0	4.7
100	4.5	0.9	2.2	860	28.3	20.5	0.72	3.43	40.0	8.2	Operation not recommended					
	4.5	0.9	2.2	1150	29.5	23.1	0.78	3.58	41.7	8.2						
	6.8	1.8	4.1	860	29.5	20.8	0.71	3.20	40.4	9.2						
	6.8	1.8	4.1	1150	30.7	23.5	0.77	3.33	42.1	9.2						
	9.0	3.3	7.5	860	30.1	21.0	0.70	3.09	40.7	9.7						
	9.0	3.3	7.5	1150	31.3	23.7	0.76	3.21	42.3	9.7						
110	4.5	0.9	2.1	860	26.2	19.8	0.76	3.84	39.3	6.8	Operation not recommended					
	4.5	0.9	2.1	1150	27.3	22.4	0.82	4.00	41.0	6.8						
	6.8	1.7	4.0	860	27.2	20.0	0.74	3.59	39.5	7.6						
	6.8	1.7	4.0	1150	28.4	22.6	0.80	3.74	41.2	7.6						
	9.0	3.1	7.2	860	27.6	20.0	0.72	3.47	39.4	7.9						
	9.0	3.1	7.2	1150	28.8	22.7	0.79	3.61	41.1	8.0						
120	4.5	0.9	2.0	860	24.1	19.0	0.79	4.27	38.7	5.6	Operation not recommended					
	4.5	0.9	2.0	1150	25.1	21.4	0.85	4.45	40.3	5.6						
	6.8	1.6	3.8	860	25.1	19.2	0.76	4.01	38.8	6.3						
	6.8	1.6	3.8	1150	26.1	21.8	0.84	4.17	40.3	6.3						
	9.0	3.0	7.0	860	25.4	19.2	0.76	3.88	38.6	6.5						
	9.0	3.0	7.0	1150	26.5	21.8	0.82	4.04	40.3	6.6						

Interpolation is permissible; extrapolation is not.
 All entering air conditions are 80°F DB and 67°F WB in cooling, and 70°F DB in heating.
 AHRI/ISO certified conditions are 80.6°F DB and 66.2°F WB in cooling and 68°F DB in heating.
 Table does not reflect fan or pump power corrections for AHRI/ISO conditions.
 All performance is based upon the lower voltage of dual voltage rated units.
 Performance stated is at the rated power supply; performance may vary as the power supply varies from the rated.
 Operation below 40°F EWT is based upon a 15% methanol antifreeze solution.
 Operation below 60°F EWT requires optional insulated water/refrigerant circuit.
 See performance correction tables for operating conditions other than those listed above.
 See Performance Data Selection Notes for operation in the shaded areas.

Performance Data – HBV 041 (PSC Blower)

1,125 CFM Nominal (Rated) Airflow

Performance capacities shown in thousands of Btu/h

EWT °F	GPM	WPD		Cooling - EAT 80/67°F						Heating - EAT 70°F					
		PSI	FT	Airflow CFM	TC	SC	kW	HR	EER	Airflow CFM	HC	kW	HE	ΔT	COP
20	10.0	8.8	20.3	Operation not recommended						845	26.6	3.17	16.5	99.1	2.5
	10.0	8.8	20.3							1125	27.2	2.85	17.6	92.4	2.8
30	5.0	2.2	5.0	845	45.0	25.2	1.64	50.5	27.4	845	28.8	3.23	18.4	101.6	2.6
	5.0	2.2	5.0	1125	46.8	28.5	1.71	52.6	27.4	1125	29.5	2.90	19.7	94.3	3.0
	7.5	4.6	10.7	845	45.8	25.3	1.51	50.8	30.4	845	29.9	3.26	19.4	102.8	2.7
	7.5	4.6	10.7	1125	47.6	28.6	1.57	52.9	30.4	1125	30.7	2.93	20.7	95.2	3.1
	10.0	7.7	17.9	845	46.1	25.3	1.44	50.9	32.1	845	30.5	3.28	20.0	103.5	2.7
	10.0	7.7	17.9	1125	48.0	28.6	1.50	53.0	32.1	1125	31.3	2.94	21.3	95.7	3.1
40	5.0	1.9	4.3	845	43.8	24.9	1.81	50.0	24.2	845	32.4	3.33	21.6	105.6	2.9
	5.0	1.9	4.3	1125	45.6	28.1	1.89	52.0	24.2	1125	33.2	2.99	23.1	97.4	3.3
	7.5	4.0	9.3	845	44.3	25.0	1.75	50.2	25.3	845	33.8	3.37	22.8	107.0	2.9
	7.5	4.0	9.3	1125	46.1	28.3	1.82	52.3	25.3	1125	34.6	3.02	24.3	98.5	3.4
	10.0	6.9	19.9	845	44.6	25.1	1.70	50.4	26.2	845	34.5	3.39	23.4	107.8	3.0
	10.0	6.9	19.9	1125	46.5	28.4	1.77	52.4	26.2	1125	35.3	3.04	25.0	99.1	3.4
50	5.0	1.6	3.6	845	42.4	24.4	1.99	49.2	21.3	845	36.1	3.43	24.8	109.6	3.1
	5.0	1.6	3.6	1125	44.2	27.6	2.07	51.2	21.3	1125	37.0	3.08	26.5	100.4	3.5
	7.5	3.5	8.0	845	43.5	24.8	1.86	49.8	23.4	845	37.6	3.47	26.2	111.2	3.2
	7.5	3.5	8.0	1125	45.3	28.0	1.93	51.8	23.4	1125	38.5	3.12	27.9	101.7	3.6
	10.0	6.1	14.2	845	44.0	24.9	1.79	50.1	24.6	845	38.4	3.50	26.9	112.1	3.2
	10.0	6.1	14.2	1125	45.8	28.2	1.86	52.1	24.6	1125	39.4	3.14	28.7	102.4	3.7
60	5.0	1.3	3.0	845	40.9	23.8	2.18	48.3	18.8	845	39.7	3.53	28.0	113.5	3.3
	5.0	1.3	3.0	1125	42.6	27.0	2.27	50.3	18.8	1125	40.7	3.17	29.9	103.5	3.8
	7.5	3.0	7.0	845	42.1	24.3	2.04	49.0	20.6	845	41.5	3.58	29.5	115.4	3.4
	7.5	3.0	7.0	1125	43.8	27.4	2.12	51.0	20.6	1125	42.5	3.22	31.5	104.9	3.9
	10.0	5.5	12.8	845	42.6	24.5	1.97	49.3	21.7	845	42.4	3.61	30.3	116.4	3.4
	10.0	5.5	12.8	1125	44.4	27.7	2.05	51.3	21.7	1125	43.4	3.24	32.4	105.7	3.9
70	5.0	1.1	2.6	845	39.2	23.2	2.39	47.3	16.4	845	43.4	3.64	31.2	117.5	3.5
	5.0	1.1	2.6	1125	40.8	26.2	2.49	49.3	16.4	1125	44.4	3.27	33.3	106.6	4.0
	7.5	2.6	6.1	845	40.5	23.6	2.23	48.1	18.1	845	45.3	3.69	32.8	119.6	3.6
	7.5	2.6	6.1	1125	42.1	26.8	2.33	50.0	18.1	1125	46.4	3.32	35.1	108.2	4.1
	10.0	5.1	11.7	845	41.1	23.9	2.16	48.4	19.0	845	46.3	3.73	33.7	120.7	3.6
	10.0	5.1	11.7	1125	42.8	27.0	2.25	50.4	19.0	1125	47.4	3.35	36.0	109.0	4.2
80	5.0	0.9	2.2	845	37.4	22.5	2.63	46.4	14.2	845	47.0	3.75	34.3	121.5	3.7
	5.0	0.9	2.2	1125	38.9	25.4	2.74	48.3	14.2	1125	48.1	3.37	36.7	109.6	4.2
	7.5	2.3	5.4	845	38.7	23.0	2.46	47.1	15.8	845	49.1	3.81	36.1	123.8	3.8
	7.5	2.3	5.4	1125	40.3	26.0	2.56	49.0	15.8	1125	50.3	3.43	38.6	111.4	4.3
	10.0	4.7	11.0	845	39.4	23.2	2.37	47.4	16.6	845	50.2	3.85	37.1	125.0	3.8
	10.0	4.7	11.0	1125	41.0	26.3	2.47	49.4	16.6	1125	51.4	3.46	39.6	112.3	4.4
85	5.0	0.9	2.0	845	36.4	22.1	2.8	45.9	13.2	845	48.8	3.81	35.9	123.5	3.8
	5.0	0.9	2.0	1125	37.9	25.0	2.88	47.8	13.2	1125	50.0	3.4	38.3	111.1	4.3
	7.5	2.2	5.1	845	37.8	22.6	2.58	46.6	14.7	845	51.0	3.9	37.8	125.9	3.9
	7.5	2.2	5.1	1125	39.3	25.6	2.69	48.5	14.7	1125	52.2	3.5	40.3	113.0	4.4
	10.0	4.6	10.7	845	38.4	22.9	2.49	46.9	15.5	845	52.1	3.9	38.8	127.1	3.9
	10.0	4.6	10.7	1125	40.0	25.9	2.60	48.9	15.5	1125	53.4	3.5	41.4	114.0	4.4
90	5.0	0.8	1.9	845	35.5	21.8	2.91	45.4	12.2	845	50.6	3.86	37.4	125.5	3.8
	5.0	0.8	1.9	1125	36.9	24.6	3.03	47.3	12.2	1125	51.8	3.47	40.0	112.7	4.4
	7.5	2.1	4.4	845	36.8	22.3	2.71	46.1	13.6	845	52.9	3.94	39.4	127.9	3.9
	7.5	2.1	4.4	1125	38.3	25.2	2.82	48.0	13.6	1125	54.1	3.54	42.0	114.6	4.5
	10.0	4.6	10.6	845	37.5	22.5	2.62	46.4	14.3	845	54.1	3.99	40.4	129.3	4.0
	10.0	4.6	10.6	1125	39.0	25.5	2.72	48.3	14.3	1125	55.4	3.58	43.2	115.6	4.5
100	5.0	0.7	1.7	845	31.4	20.4	3.61	43.7	8.7	Operation not recommended					
	5.0	0.7	1.7	1125	32.7	23.0	3.76	45.5	8.7						
	7.5	2.0	4.5	845	32.8	20.8	3.35	44.2	9.8						
	7.5	2.0	4.5	1125	34.1	23.6	3.49	46.1	9.8						
	10.0	4.5	10.5	845	33.5	21.1	3.23	44.5	10.4						
	10.0	4.5	10.5	1125	34.9	23.8	3.36	46.4	10.4						
110	5.0	0.7	1.5	845	29.3	19.7	4.05	43.2	7.2	Operation not recommended					
	5.0	0.7	1.5	1125	30.5	22.3	4.22	44.9	7.2						
	7.5	1.9	4.4	845	30.7	20.1	3.75	43.5	8.2						
	7.5	1.9	4.4	1125	31.9	22.8	3.91	45.3	8.2						
	10.0	4.6	10.7	845	31.4	20.4	3.61	43.7	8.7						
	10.0	4.6	10.7	1125	32.7	23.0	3.76	45.5	8.7						
120	5.0	0.7	1.5	845	27.6	19.2	4.45	42.9	6.2	Operation not recommended					
	5.0	0.7	1.5	1125	28.7	21.7	4.63	44.6	6.2						
	7.5	1.9	4.4	845	29.0	19.6	4.11	43.1	7.1						
	7.5	1.9	4.4	1125	30.2	22.2	4.28	44.9	7.1						
	10.0	4.8	11.2	845	29.7	19.8	3.95	43.3	7.5						
	10.0	4.8	11.2	1125	30.9	22.4	4.12	45.0	7.5						

Interpolation is permissible, extrapolation is not.
 All entering air conditions are 80°F DB and 67°F WB in cooling and 70°F DB in heating.
 ARI/ISO certified conditions are 80.6°F DB and 66.2°F WB in cooling and 68°F DB in heating.
 Table does not reflect fan or pump power corrections for ARI/ISO conditions.
 All performance is based upon the lower value of dual voltage rated units.
 Performance stated is at the rated power supply; performance may vary as the power supply varies from the rated.
 Operation below 40°F EWT is based upon a 15% antifreeze solution.
 Operation below 60°F EWT requires optional insulated water/refrigerant circuit.
 See performance correction tables for operating conditions other than those listed above.
 See Performance Data Selection Notes for operation in the shaded areas.

Performance Data – HBH/V 042 (PSC Blower)

1,350 CFM Nominal (Rated) Airflow

Performance capacities shown in thousands of Btu/h

EWT °F	GPM	WPD		Cooling - EAT 80/67°F							Heating - EAT 70°F					
		PSI	FT	Airflow CFM	TC	SC	Sens/Tot Ratio	kW	HR	EER	Airflow CFM	HC	⁵ kW	HE	LAT	COP
20	10.5	9.2	21.3	Operation not recommended							1050	28.8	3.37	18.1	95	2.51
	10.5	9.2	21.3	Operation not recommended							1400	29.5	3.03	19.3	90	2.86
30	5.3	2.3	5.3	1050	47.4	30.6	0.65	1.87	53.7	25.4	1050	31.6	3.45	20.5	98	2.68
	5.3	2.3	5.3	1400	49.3	34.7	0.70	1.95	55.9	25.4	1400	32.4	3.10	21.9	91	3.06
	7.9	4.3	10.0	1050	48.4	31.1	0.64	1.76	54.4	27.5	1050	32.9	3.49	21.6	99	2.76
	7.9	4.3	10.0	1400	50.4	35.2	0.70	1.83	56.6	27.5	1400	33.7	3.14	23.1	92	3.15
	10.5	7.9	18.2	1050	48.9	31.3	0.64	1.71	54.7	28.6	1050	33.6	3.52	22.3	100	2.80
	10.5	7.9	18.2	1400	50.9	35.5	0.70	1.78	57.0	28.6	1400	34.5	3.16	23.8	93	3.20
40	5.3	2.0	4.6	1050	45.9	29.9	0.65	2.05	52.8	22.4	1050	36.1	3.59	24.4	102	2.95
	5.3	2.0	4.6	1400	47.8	33.9	0.71	2.13	55.0	22.4	1400	37.0	3.23	26.1	94	3.36
	7.9	3.9	8.9	1050	47.0	30.4	0.65	1.92	53.4	24.5	1050	37.8	3.64	25.8	103	3.04
	7.9	3.9	8.9	1400	48.9	34.4	0.70	2.00	55.6	24.5	1400	38.7	3.27	27.6	96	3.46
	10.5	7.1	16.4	1050	47.5	30.7	0.65	1.86	53.8	25.5	1050	38.7	3.67	26.6	104	3.09
	10.5	7.1	16.4	1400	49.4	34.7	0.70	1.94	56.0	25.5	1400	39.6	3.30	28.4	96	3.52
50	5.3	1.8	4.1	1050	44.4	29.2	0.66	2.26	52.0	19.6	1050	40.8	3.74	28.5	106	3.20
	5.3	1.8	4.1	1400	46.2	33.1	0.72	2.35	54.2	19.6	1400	41.8	3.36	30.4	98	3.65
	7.9	3.5	8.1	1050	45.4	29.7	0.65	2.11	52.6	21.5	1050	42.8	3.80	30.2	108	3.30
	7.9	3.5	8.1	1400	47.3	33.6	0.71	2.20	54.8	21.5	1400	43.8	3.41	32.2	99	3.76
	10.5	6.5	15.0	1050	46.0	30.0	0.65	2.04	52.9	22.5	1050	43.9	3.83	31.1	109	3.35
	10.5	6.5	15.0	1400	47.9	33.9	0.71	2.12	55.1	22.5	1400	44.9	3.44	33.2	100	3.82
60	5.3	1.6	3.7	1050	43.1	28.8	0.67	2.51	51.7	17.2	1050	45.6	3.89	32.6	110	3.44
	5.3	1.6	3.7	1400	44.9	32.6	0.73	2.61	53.8	17.2	1400	46.7	3.49	34.8	101	3.92
	7.9	3.3	7.5	1050	43.9	29.0	0.66	2.34	51.8	18.8	1050	47.8	3.96	34.5	112	3.54
	7.9	3.3	7.5	1400	45.7	32.8	0.72	2.43	53.9	18.8	1400	49.0	3.56	36.9	102	4.04
	10.5	6.1	14.0	1050	44.4	29.2	0.66	2.25	52.1	19.7	1050	49.0	4.00	35.6	113	3.60
	10.5	6.1	14.0	1400	46.2	33.1	0.72	2.35	54.2	19.7	1400	50.2	3.59	38.0	103	4.10
70	5.3	1.5	3.4	1050	41.3	28.1	0.68	2.80	50.9	14.8	1050	50.3	4.04	36.7	114	3.65
	5.3	1.5	3.4	1400	43.0	31.8	0.74	2.91	52.9	14.8	1400	51.5	3.63	39.2	104	4.16
	7.9	3.1	7.1	1050	42.2	28.3	0.67	2.60	51.0	16.2	1050	52.8	4.11	38.8	117	3.76
	7.9	3.1	7.1	1400	43.9	32.0	0.73	2.71	53.1	16.2	1400	54.1	3.70	41.5	106	4.29
	10.5	5.7	13.2	1050	42.8	28.5	0.67	2.51	51.3	17.1	1050	54.1	4.16	40.0	118	3.82
	10.5	5.7	13.2	1400	44.5	32.3	0.73	2.61	53.4	17.1	1400	55.4	3.73	42.7	107	4.35
80	5.3	1.4	3.2	1050	39.5	27.4	0.70	3.13	50.1	12.6	1050	54.9	4.18	40.7	118	3.85
	5.3	1.4	3.2	1400	41.1	31.0	0.76	3.26	52.2	12.6	1400	56.3	3.76	43.4	107	4.39
	7.9	2.9	6.7	1050	40.4	27.6	0.68	2.91	50.3	13.9	1050	57.6	4.27	43.0	121	3.96
	7.9	2.9	6.7	1400	42.1	31.3	0.74	3.03	52.4	13.9	1400	59.0	3.83	45.9	109	4.51
	10.5	5.4	12.6	1050	41.0	27.9	0.68	2.80	50.6	14.6	1050	59.0	4.31	44.2	122	4.01
	10.5	5.4	12.6	1400	42.7	31.5	0.74	2.92	52.6	14.6	1400	60.4	3.87	47.2	110	4.58
85	5.3	1.3	3.1	1050	38.4	27.1	0.71	3.32	49.8	11.6	1050	57.2	4.25	42.6	120	3.94
	5.3	1.3	3.1	1400	40.0	30.7	0.77	3.46	51.8	11.6	1400	58.6	3.82	45.5	109	4.49
	7.9	2.8	6.5	1050	39.4	27.3	0.69	3.08	50.0	12.8	1050	59.9	4.34	44.9	123	4.05
	7.9	2.8	6.5	1400	41.1	30.9	0.75	3.21	52.0	12.9	1400	61.3	3.89	48.0	111	4.61
	10.5	5.3	12.3	1050	40.1	27.5	0.69	2.97	50.2	13.5	1050	61.3	4.38	46.2	124	4.10
	10.5	5.3	12.3	1400	41.7	31.2	0.75	3.09	52.3	13.6	1400	62.7	3.93	49.3	111	4.68
90	5.3	1.3	3.0	1050	37.4	26.8	0.72	3.51	49.4	10.7	1050	59.4	4.32	44.6	122	4.03
	5.3	1.3	3.0	1400	39.0	30.3	0.78	3.65	51.5	10.7	1400	60.8	3.88	47.6	110	4.59
	7.9	2.8	6.4	1050	38.5	27.0	0.70	3.26	49.6	11.8	1050	62.1	4.40	46.9	125	4.13
	7.9	2.8	6.4	1400	40.1	30.6	0.76	3.39	51.6	11.8	1400	63.6	3.96	50.1	112	4.71
	10.5	5.2	12.0	1050	39.1	27.2	0.70	3.14	49.8	12.5	1050	63.5	4.45	48.1	126	4.19
	10.5	5.2	12.0	1400	40.7	30.8	0.76	3.27	51.9	12.5	1400	65.1	3.99	51.4	113	4.77
100	5.3	1.2	2.8	1050	35.2	26.2	0.74	3.94	48.7	8.9	Operation not recommended					
	5.3	1.2	2.8	1400	36.7	29.6	0.81	4.10	50.7	8.9						
	7.9	2.7	6.1	1050	36.4	26.4	0.73	3.66	48.9	9.9						
	7.9	2.7	6.1	1400	37.9	29.9	0.79	3.81	50.9	9.9						
	10.5	5.0	11.6	1050	37.1	26.6	0.72	3.52	49.1	10.5						
	10.5	5.0	11.6	1400	38.6	30.1	0.78	3.67	51.1	10.5						
110	5.3	1.2	2.7	1050	32.8	25.5	0.78	4.41	47.9	7.4	Operation not recommended					
	5.3	1.2	2.7	1400	34.2	28.9	0.85	4.60	49.9	7.4						
	7.9	2.6	5.9	1050	34.1	25.7	0.76	4.11	48.1	8.3						
	7.9	2.6	5.9	1400	35.5	29.1	0.82	4.28	50.1	8.3						
	10.5	4.8	11.2	1050	34.8	25.9	0.75	3.96	48.4	8.8						
	10.5	4.8	11.2	1400	36.2	29.4	0.81	4.12	50.4	8.8						
120	5.3	1.1	2.6	1050	30.2	24.8	0.82	4.95	47.1	6.1	Operation not recommended					
	5.3	1.1	2.6	1400	31.4	28.0	0.89	5.15	49.1	6.1						
	7.9	2.5	5.7	1050	31.5	25.0	0.79	4.61	47.3	6.8						
	7.9	2.5	5.7	1400	32.8	28.3	0.86	4.80	49.3	6.8						
	10.5	4.7	10.8	1050	32.3	25.3	0.78	4.45	47.6	7.3						
	10.5	4.7	10.8	1400	33.7	28.6	0.85	4.63	49.5	7.3						

Interpolation is permissible; extrapolation is not.
 All entering air conditions are 80°F DB and 67°F WB in cooling, and 70°F DB in heating.
 AHRI/ISO certified conditions are 80.6°F DB and 66.2°F WB in cooling and 68°F DB in heating.
 Table does not reflect fan or pump power corrections for AHRI/ISO conditions.
 All performance is based upon the lower voltage of dual voltage rated units.
 Performance stated is at the rated power supply; performance may vary as the power supply varies from the rated.
 Operation below 40°F EWT is based upon a 15% methanol antifreeze solution.
 Operation below 60°F EWT requires optional insulated water/refrigerant circuit.
 See performance correction tables for operating conditions other than those listed above.
 See Performance Data Selection Notes for operation in the shaded areas.

Performance Data – HBH/V 042 (ECM Blower)

1300 CFM Nominal (Rated) Airflow

Performance capacities shown in thousands of Btu/h

EWT °F	GPM	WPD		Cooling - EAT 80/67°F							Heating - EAT 70°F					
		PSI	FT	Airflow CFM	TC	SC	Sens/Tot Ratio	kW	HR	EER	Airflow CFM	HC	kW	HE	LAT	COP
20	10.5	9.2	21.3	Operation not recommended							860	18.1	3.21	18.1	92.0	1.7
	10.5	9.2	21.3								1150	19.3	2.87	19.3	87.0	2.0
30	5.3	2.3	5.3	1050	47.4	30.6	0.65	1.71	0.1	27.7	860	20.5	3.29	20.5	95.0	1.8
	5.3	2.3	5.3	1400	49.3	34.7	0.70	1.79	0.1	27.5	1150	21.9	2.94	21.9	89.0	2.2
	7.9	4.3	10.0	1050	48.4	31.1	0.64	1.60	0.1	30.2	860	21.6	3.33	21.6	96.0	1.9
	7.9	4.3	10.0	1400	50.4	35.2	0.70	1.67	0.1	30.2	1150	23.1	2.98	23.1	90.0	2.3
	10.5	7.9	18.2	1050	48.9	31.3	0.64	1.55	0.1	31.5	860	22.3	3.36	22.3	97.0	1.9
	10.5	7.9	18.2	1400	50.9	35.5	0.70	1.62	0.1	31.4	1150	23.8	3.00	23.8	90.0	2.3
40	5.3	2.0	4.6	1050	45.9	29.9	0.65	1.89	0.1	24.3	860	24.4	3.43	24.4	99.0	2.1
	5.3	2.0	4.6	1400	47.8	33.9	0.71	1.97	0.1	24.3	1150	26.1	3.07	26.1	92.0	2.5
	7.9	3.9	8.9	1050	47.0	30.4	0.65	1.76	0.1	26.7	860	25.8	3.48	25.8	100.0	2.2
	7.9	3.9	8.9	1400	48.9	34.4	0.70	1.84	0.1	26.6	1150	27.6	3.11	27.6	93.0	2.6
	10.5	7.1	16.4	1050	47.5	30.7	0.65	1.70	0.1	27.9	860	26.6	3.51	26.6	101.0	2.2
	10.5	7.1	16.4	1400	49.4	34.7	0.70	1.78	0.1	27.8	1150	28.4	3.14	28.4	94.0	2.7
50	5.3	1.8	4.1	1050	44.4	29.2	0.66	2.10	0.1	21.1	860	28.5	3.58	28.5	103.0	2.3
	5.3	1.8	4.1	1400	46.2	33.1	0.72	2.19	0.1	21.1	1150	30.4	3.20	30.4	95.0	2.8
	7.9	3.5	8.1	1050	45.4	29.7	0.65	1.95	0.1	23.3	860	30.2	3.64	30.2	104.0	2.4
	7.9	3.5	8.1	1400	47.3	33.6	0.71	2.04	0.1	23.2	1150	32.2	3.25	32.2	96.0	2.9
	10.5	6.5	15.0	1050	46.0	30.0	0.65	1.88	0.1	24.5	860	31.1	3.67	31.1	105.0	2.5
	10.5	6.5	15.0	1400	47.9	33.9	0.71	1.96	0.1	24.4	1150	33.2	3.28	33.2	97.0	3.0
60	5.3	1.6	3.7	1050	43.1	28.8	0.67	2.35	0.1	18.3	860	32.6	3.73	32.6	106.0	2.6
	5.3	1.6	3.7	1400	44.9	32.6	0.73	2.45	0.1	18.3	1150	34.8	3.33	34.8	98.0	3.1
	7.9	3.3	7.5	1050	43.9	29.0	0.66	2.18	0.1	20.1	860	34.5	3.80	34.5	108.0	2.7
	7.9	3.3	7.5	1400	45.7	32.8	0.72	2.27	0.1	20.1	1150	36.9	3.40	36.9	99.0	3.2
	10.5	6.1	14.0	1050	44.4	29.2	0.66	2.09	0.1	21.2	860	35.6	3.84	35.6	109.0	2.7
	10.5	6.1	14.0	1400	46.2	33.1	0.72	2.19	0.1	21.1	1150	38.0	3.43	38.0	100.0	3.2
70	5.3	1.5	3.4	1050	41.3	28.1	0.68	2.64	0.1	15.6	860	36.7	3.88	36.7	110.0	2.8
	5.3	1.5	3.4	1400	43.0	31.8	0.74	2.75	0.1	15.6	1150	39.2	3.47	39.2	101.0	3.3
	7.9	3.1	7.1	1050	42.2	28.3	0.67	2.44	0.1	17.3	860	38.8	3.95	38.8	112.0	2.9
	7.9	3.1	7.1	1400	43.9	32.0	0.73	2.55	0.1	17.2	1150	41.5	3.54	41.5	102.0	3.4
	10.5	5.7	13.2	1050	42.8	28.5	0.67	2.35	0.1	18.2	860	40.0	4.00	40.0	113.0	2.9
	10.5	5.7	13.2	1400	44.5	32.3	0.73	2.45	0.1	18.2	1150	42.7	3.57	42.7	103.0	3.5
80	5.3	1.4	3.2	1050	39.5	27.4	0.69	2.97	0.0	13.3	860	40.7	4.02	40.7	114.0	3.0
	5.3	1.4	3.2	1400	41.1	31.0	0.75	3.10	0.1	13.3	1150	43.4	3.60	43.4	104.0	3.5
	7.9	2.9	6.7	1050	40.4	27.6	0.68	2.75	0.0	14.7	860	43.0	4.11	43.0	116.0	3.1
	7.9	2.9	6.7	1400	42.1	31.3	0.74	2.87	0.1	14.7	1150	45.9	3.67	45.9	105.0	3.7
	10.5	5.4	12.6	1050	41.0	27.9	0.68	2.64	0.1	15.5	860	44.2	4.15	44.2	117.0	3.1
	10.5	5.4	12.6	1400	42.7	31.5	0.74	2.76	0.1	15.5	1150	47.2	3.71	47.2	106.0	3.7
85	5.3	1.3	3.1	1050	38.4	27.1	0.71	3.16	0.0	12.2	860	42.6	4.09	42.6	116.0	3.1
	5.3	1.3	3.1	1400	40.0	30.7	0.77	3.30	0.1	12.1	1150	45.5	3.66	45.5	105.0	3.6
	7.9	2.8	6.5	1050	39.4	27.3	0.69	2.92	0.0	13.5	860	44.9	4.18	44.9	118.0	3.1
	7.9	2.8	6.5	1400	41.1	30.9	0.75	3.05	0.1	13.5	1150	48.0	3.73	48.0	107.0	3.8
	10.5	5.3	12.3	1050	40.1	27.5	0.69	2.81	0.0	14.3	860	46.2	4.22	46.2	119.0	3.2
	10.5	5.3	12.3	1400	41.7	31.2	0.75	2.93	0.1	14.2	1150	49.3	3.77	49.3	108.0	3.8
90	5.3	1.3	3.0	1050	37.4	26.8	0.72	3.35	0.0	11.2	860	44.6	4.16	44.6	117.0	3.1
	5.3	1.3	3.0	1400	39.0	30.3	0.78	3.49	0.1	11.2	1150	47.6	3.72	47.6	107.0	3.8
	7.9	2.8	6.4	1050	38.5	27.0	0.70	3.10	0.0	12.4	860	46.9	4.24	46.9	120.0	3.2
	7.9	2.8	6.4	1400	40.1	30.6	0.76	3.23	0.1	12.4	1150	50.1	3.80	50.1	108.0	3.9
	10.5	5.2	12.0	1050	39.1	27.2	0.70	2.98	0.0	13.1	860	48.1	4.29	48.1	121.0	3.3
	10.5	5.2	12.0	1400	40.7	30.8	0.76	3.11	0.1	13.1	1150	51.4	3.83	51.4	109.0	3.9
100	5.3	1.2	2.8	1050	35.2	26.2	0.74	3.78	0.0	9.3	Operation not recommended					
	5.3	1.2	2.8	1400	36.7	29.6	0.81	3.94	0.1	9.3						
	7.9	2.7	6.1	1050	36.4	26.4	0.73	3.50	0.0	10.4						
	7.9	2.7	6.1	1400	37.9	29.9	0.79	3.65	0.1	10.4						
	10.5	5.0	11.6	1050	37.1	26.6	0.72	3.36	0.0	11.0						
	10.5	5.0	11.6	1400	38.6	30.1	0.78	3.51	0.1	11.0						
110	5.3	1.2	2.7	1050	32.8	25.5	0.78	4.25	0.0	7.7	Operation not recommended					
	5.3	1.2	2.7	1400	34.2	28.9	0.85	4.44	0.0	7.7						
	7.9	2.6	5.9	1050	34.1	25.7	0.75	3.95	0.0	8.6						
	7.9	2.6	5.9	1400	35.5	29.1	0.82	4.12	0.0	8.6						
	10.5	4.8	11.2	1050	34.8	25.9	0.74	3.80	0.0	9.2						
	10.5	4.8	11.2	1400	36.2	29.4	0.81	3.96	0.0	9.1						
120	5.3	1.1	2.6	1050	30.2	24.8	0.82	4.79	0.0	6.3	Operation not recommended					
	5.3	1.1	2.6	1400	31.4	28.0	0.89	4.99	0.0	6.3						
	7.9	2.5	5.7	1050	31.5	25.0	0.79	4.45	0.0	7.1						
	7.9	2.5	5.7	1400	32.8	28.3	0.86	4.64	0.0	7.1						
	10.5	4.7	10.8	1050	32.3	25.3	0.78	4.29	0.0	7.5						
	10.5	4.7	10.8	1400	33.7	28.6	0.85	4.47	0.0	7.5						

Interpolation is permissible; extrapolation is not.
 All entering air conditions are 80°F DB and 67°F WB in cooling, and 70°F DB in heating.
 AHR/ISO certified conditions are 80.6°F DB and 66.2°F WB in cooling and 68°F DB in heating.
 Table does not reflect fan or pump power corrections for AHR/ISO conditions.
 All performance is based upon the lower voltage of dual voltage rated units.
 Performance stated is at the rated power supply; performance may vary as the power supply varies from the rated.
 Operation below 40°F EWT is based upon a 15% methanol antifreeze solution.
 Operation below 60°F EWT requires optional insulated water/refrigerant circuit.
 See performance correction tables for operating conditions other than those listed above.
 See Performance Data Selection Notes for operation in the shaded areas.

Performance Data – HBH/V 048 (PSC Blower)

1,600 CFM Nominal (Rated) Airflow

Performance capacities shown in thousands of Btu/h

EWT °F	GPM	WPD		Cooling - EAT 80/67°F							Heating - EAT 70°F					
		PSI	FT	Airflow CFM	TC	SC	Sens/Tot Ratio	kW	HR	EER	Airflow CFM	HC	kW	HE	LAT	COP
20	12.0	6.8	15.6	Operation not recommended							1200	30.9	3.54	19.6	94	2.56
	12.0	6.8	15.6	Operation not recommended							1600	31.6	3.18	20.9	88	2.92
30	6.0	1.8	4.1	1200	56.4	34.4	0.61	2.25	64.0	25.1	1200	33.9	3.60	22.3	96	2.76
	6.0	1.8	4.1	1600	58.8	39.0	0.66	2.34	66.7	25.1	1600	34.7	3.24	23.8	90	3.14
	9.0	3.4	7.8	1200	57.5	34.6	0.60	2.11	64.6	27.2	1200	34.4	3.63	22.7	97	2.78
	9.0	3.4	7.8	1600	59.8	39.1	0.65	2.20	67.2	27.2	1600	35.3	3.26	24.2	90	3.17
	12.0	6.2	14.3	1200	57.9	34.5	0.60	2.05	64.8	28.2	1200	35.1	3.65	23.3	97	2.82
	12.0	6.2	14.3	1600	60.3	39.1	0.65	2.14	67.5	28.2	1600	36.0	3.27	24.9	91	3.22
40	6.0	1.6	3.7	1200	54.8	34.0	0.62	2.47	63.2	22.2	1200	37.9	3.70	25.8	99	3.00
	6.0	1.6	3.7	1600	57.1	38.5	0.67	2.57	65.8	22.2	1600	38.8	3.33	27.5	92	3.42
	9.0	3.1	7.2	1200	56.0	34.3	0.61	2.31	63.8	24.3	1200	39.5	3.74	27.2	100	3.10
	9.0	3.1	7.2	1600	58.3	38.9	0.67	2.40	66.4	24.3	1600	40.5	3.36	29.1	93	3.53
	12.0	5.8	13.4	1200	56.6	34.5	0.61	2.23	64.1	25.4	1200	40.7	3.76	28.3	101	3.18
	12.0	5.8	13.4	1600	58.9	39.0	0.66	2.32	66.8	25.4	1600	41.7	3.37	30.2	94	3.62
50	6.0	1.5	3.4	1200	52.9	33.3	0.63	2.72	62.1	19.4	1200	43.6	3.81	31.0	104	3.36
	6.0	1.5	3.4	1600	55.1	37.7	0.68	2.83	64.7	19.4	1600	44.7	3.42	33.0	96	3.83
	9.0	3.0	6.8	1200	54.3	33.8	0.62	2.53	62.9	21.4	1200	44.9	3.85	32.1	105	3.22
	9.0	3.0	6.8	1600	56.5	38.3	0.68	2.64	65.5	21.4	1600	46.0	3.46	34.3	97	3.90
	12.0	5.5	12.7	1200	55.0	34.0	0.62	2.45	63.2	22.5	1200	46.0	3.87	33.1	106	3.49
	12.0	5.5	12.7	1600	57.2	38.5	0.67	2.55	65.8	22.5	1600	47.1	3.48	35.3	97	3.98
60	6.0	1.4	3.2	1200	50.7	32.5	0.64	3.02	61.0	16.8	1200	48.2	3.91	35.0	107	3.61
	6.0	1.4	3.2	1600	52.8	36.8	0.70	3.15	63.5	16.8	1600	49.3	3.51	37.4	99	4.11
	9.0	2.8	6.5	1200	52.3	33.1	0.63	2.81	61.8	18.6	1200	50.5	3.96	37.1	109	3.74
	9.0	2.8	6.5	1600	54.5	37.5	0.69	2.92	64.4	18.6	1600	51.8	3.56	39.6	100	4.26
	12.0	5.3	12.2	1200	53.0	33.4	0.63	2.70	62.2	19.6	1200	51.8	3.99	38.3	110	3.81
	12.0	5.3	12.2	1600	55.2	37.8	0.68	2.81	64.8	19.6	1600	53.1	3.58	40.9	101	4.34
70	6.0	1.3	3.0	1200	48.3	31.5	0.65	3.38	59.9	14.3	1200	53.5	4.02	39.8	111	3.90
	6.0	1.3	3.0	1600	50.3	35.7	0.71	3.52	62.3	14.3	1600	54.8	3.61	42.4	102	4.44
	9.0	2.7	6.3	1200	50.0	32.2	0.64	3.13	60.7	16.0	1200	56.2	4.08	42.2	113	4.03
	9.0	2.7	6.3	1600	52.1	36.4	0.70	3.25	63.2	16.0	1600	57.5	3.67	45.0	103	4.60
	12.0	5.1	11.8	1200	50.9	32.5	0.64	3.01	61.1	16.9	1200	57.6	4.12	43.4	114	4.10
	12.0	5.1	11.8	1600	53.0	36.8	0.70	3.13	63.6	16.9	1600	59.0	3.70	46.4	104	4.68
80	6.0	1.3	2.9	1200	45.7	30.5	0.67	3.79	58.6	12.1	1200	58.8	4.14	44.5	115	4.16
	6.0	1.3	2.9	1600	47.6	34.5	0.72	3.94	61.0	12.1	1600	60.2	3.72	47.5	105	4.74
	9.0	2.6	6.1	1200	47.5	31.2	0.66	3.50	59.5	13.6	1200	61.7	4.21	47.1	118	4.29
	9.0	2.6	6.1	1600	49.5	35.3	0.71	3.64	61.9	13.6	1600	63.2	3.78	50.2	107	4.90
	12.0	4.9	11.4	1200	48.4	31.6	0.65	3.37	59.9	14.4	1200	63.3	4.25	48.4	119	4.36
	12.0	4.9	11.4	1600	50.4	35.7	0.71	3.50	62.4	14.4	1600	64.8	3.82	51.7	107	4.97
85	6.0	1.2	2.8	1200	44.3	29.9	0.68	4.02	58.0	11.1	1200	61.3	4.20	46.7	117	4.28
	6.0	1.2	2.8	1600	46.1	33.8	0.73	4.19	60.4	11.1	1600	62.8	3.78	49.9	106	4.88
	9.0	2.6	6.0	1200	46.2	30.6	0.66	3.72	58.8	12.5	1200	64.3	4.28	49.4	120	4.40
	9.0	2.6	6.0	1600	48.1	34.7	0.72	3.87	61.3	12.5	1600	65.9	3.84	52.7	108	5.02
	12.0	4.9	11.3	1200	47.1	31.0	0.66	3.57	59.3	13.2	1200	65.9	4.32	50.7	121	4.47
	12.0	4.9	11.3	1600	49.0	35.1	0.72	3.72	61.7	13.2	1600	67.5	3.88	54.1	109	5.09
90	6.0	1.2	2.8	1200	42.9	29.3	0.68	4.26	57.4	10.1	1200	63.9	4.27	49.0	119	4.39
	6.0	1.2	2.8	1600	44.6	33.2	0.74	4.43	59.8	10.1	1600	65.5	3.83	52.3	108	5.01
	9.0	2.6	5.9	1200	44.8	30.1	0.67	3.93	58.2	11.4	1200	66.9	4.35	51.7	122	4.51
	9.0	2.6	5.9	1600	46.6	34.1	0.73	4.10	60.6	11.4	1600	68.6	3.91	55.1	110	5.14
	12.0	4.8	11.1	1200	45.7	30.5	0.67	3.78	58.6	12.1	1200	68.5	4.39	53.0	123	4.57
	12.0	4.8	11.1	1600	47.6	34.5	0.72	3.94	61.1	12.1	1600	70.2	3.95	56.6	111	5.21
100	6.0	1.2	2.7	1200	39.8	28.2	0.71	4.79	56.2	8.3	Operation not recommended					
	6.0	1.2	2.7	1600	41.4	31.9	0.77	4.99	58.5	8.3						
	9.0	2.5	5.8	1200	41.8	28.9	0.69	4.43	57.0	9.4						
	9.0	2.5	5.8	1600	43.5	32.7	0.75	4.62	59.3	9.4						
	12.0	4.7	10.9	1200	42.8	29.3	0.69	4.26	57.4	10.0						
	12.0	4.7	10.9	1600	44.6	33.2	0.74	4.44	59.7	10.0						
110	6.0	1.1	2.6	1200	36.5	26.9	0.74	5.40	55.0	6.8						
	6.0	1.1	2.6	1600	38.0	30.4	0.80	5.62	57.3	6.8						
	9.0	2.4	5.6	1200	38.6	27.7	0.72	5.00	55.8	7.7						
	9.0	2.4	5.6	1600	40.2	31.4	0.78	5.21	58.0	7.7						
	12.0	4.6	10.6	1200	39.7	28.1	0.71	4.81	56.1	8.2						
	12.0	4.6	10.6	1600	41.3	31.8	0.77	5.01	58.5	8.2						
120	6.0	1.1	2.5	1200	33.0	25.5	0.77	6.09	53.9	5.4						
	6.0	1.1	2.5	1600	34.4	28.9	0.84	6.34	56.1	5.4						
	9.0	2.4	5.5	1200	35.2	26.4	0.75	5.65	54.6	6.2						
	9.0	2.4	5.5	1600	36.7	29.9	0.81	5.88	56.8	6.2						
	12.0	4.5	10.4	1200	36.3	26.8	0.74	5.44	55.0	6.7						
	12.0	4.5	10.4	1600	37.8	30.3	0.80	5.66	57.2	6.7						

Interpolation is permissible; extrapolation is not.
 All entering air conditions are 80°F DB and 67°F WB in cooling, and 70°F DB in heating.
 AHRI/ISO certified conditions are 80.6°F DB and 66.2°F WB in cooling and 68°F DB in heating.
 Table does not reflect fan or pump power corrections for AHRI/ISO conditions.
 All performance is based upon the lower voltage of dual voltage rated units.
 Performance stated is at the rated power supply; performance may vary as the power supply varies from the rated.
 Operation below 40°F EWT is based upon a 15% methanol antifreeze solution.
 Operation below 60°F EWT requires optional insulated water/refrigerant circuit.
 See performance correction tables for operating conditions other than those listed above.
 See Performance Data Selection Notes for operation in the shaded areas.

Performance Data – HBH/V 048 (ECM Blower)

1500 CFM Nominal (Rated) Airflow

Performance capacities shown in thousands of Btu/h

EWT °F	GPM	WPD		Cooling - EAT 80/67°F							Heating - EAT 70°F					
		PSI	FT	Airflow CFM	TC	SC	Sens/Tot Ratio	kW	HR	EER	Airflow CFM	HC	kW	HE	LAT	COP
20	12.0	6.8	15.6	Operation not recommended							1200	31.4	3.45	19.6	92.0	2.7
	12.0	6.8	15.6								1600	31.5	3.09	20.9	87.0	3.0
30	6.0	1.8	4.1	1200	56.4	34.4	0.61	2.16	63.8	26.1	1200	34.3	3.51	22.3	95.0	2.9
	6.0	1.8	4.1	1600	58.8	39.0	0.66	2.25	66.5	26.1	1600	34.6	3.15	23.8	89.0	3.2
	9.0	3.4	7.8	1200	57.5	34.6	0.60	2.02	64.4	28.4	1200	34.8	3.54	22.7	96.0	2.9
	9.0	3.4	7.8	1600	59.8	39.1	0.65	2.11	67.0	28.3	1600	35.0	3.17	24.2	90.0	3.2
	12.0	6.2	14.3	1200	57.9	34.5	0.60	1.96	64.6	29.5	1200	35.5	3.56	23.3	97.0	2.9
	12.0	6.2	14.3	1600	60.3	39.1	0.65	2.05	67.3	29.4	1600	35.8	3.18	24.9	90.0	3.3
40	6.0	1.6	3.7	1200	54.8	34.0	0.62	2.38	62.9	23.0	1200	38.1	3.61	25.8	99.0	3.1
	6.0	1.6	3.7	1600	57.1	38.5	0.67	2.48	65.6	23.0	1600	38.6	3.24	27.5	92.0	3.5
	9.0	3.1	7.2	1200	56.0	34.3	0.61	2.22	63.6	25.2	1200	39.7	3.65	27.2	100.0	3.2
	9.0	3.1	7.2	1600	58.3	38.9	0.67	2.31	66.2	25.2	1600	40.3	3.27	29.1	93.0	3.6
	12.0	5.8	13.4	1200	56.6	34.5	0.61	2.14	63.9	26.4	1200	40.8	3.67	28.3	101.0	3.3
	12.0	5.8	13.4	1600	58.9	39.0	0.66	2.23	66.5	26.4	1600	41.4	3.28	30.2	94.0	3.7
50	6.0	1.5	3.4	1200	52.9	33.3	0.63	2.63	61.9	20.1	1200	43.7	3.72	31.0	103.0	3.4
	6.0	1.5	3.4	1600	55.1	37.7	0.68	2.74	64.5	20.1	1600	44.4	3.33	33.0	95.0	3.9
	9.0	3.0	6.8	1200	54.3	33.8	0.62	2.44	62.6	22.2	1200	44.9	3.76	32.1	104.0	3.5
	9.0	3.0	6.8	1600	56.5	38.3	0.68	2.55	65.2	22.1	1600	45.8	3.37	34.3	96.0	4.0
	12.0	5.5	12.7	1200	55.0	34.0	0.62	2.36	63.1	23.3	1200	46.0	3.78	33.1	105.0	3.6
	12.0	5.5	12.7	1600	57.2	38.5	0.67	2.46	65.6	23.2	1600	46.9	3.39	35.3	97.0	4.0
60	6.0	1.4	3.2	1200	50.7	32.5	0.64	2.93	60.7	17.3	1200	48.0	3.82	35.0	106.0	3.7
	6.0	1.4	3.2	1600	52.8	36.8	0.70	3.06	63.3	17.2	1600	49.1	3.42	37.4	98.0	4.2
	9.0	2.8	6.5	1200	52.3	33.1	0.63	2.72	61.6	19.2	1200	50.3	3.87	37.1	108.0	3.8
	9.0	2.8	6.5	1600	54.5	37.5	0.69	2.83	64.2	19.2	1600	51.5	3.47	39.6	99.0	4.3
	12.0	5.3	12.2	1200	53.0	33.4	0.63	2.61	61.9	20.3	1200	51.6	3.90	38.3	109.0	3.9
	12.0	5.3	12.2	1600	55.2	37.8	0.68	2.72	64.5	20.3	1600	52.8	3.49	40.9	100.0	4.4
70	6.0	1.3	3.0	1200	48.3	31.5	0.65	3.29	59.5	14.7	1200	53.2	3.93	39.8	110.0	4.0
	6.0	1.3	3.0	1600	50.3	35.7	0.71	3.43	62.0	14.6	1600	54.4	3.52	42.4	101.0	4.5
	9.0	2.7	6.3	1200	50.0	32.2	0.64	3.04	60.4	16.4	1200	55.8	3.99	42.2	112.0	4.1
	9.0	2.7	6.3	1600	52.1	36.4	0.70	3.16	62.9	16.5	1600	57.2	3.58	45.0	102.0	4.7
	12.0	5.1	11.8	1200	50.9	32.5	0.64	2.92	60.9	17.4	1200	57.2	4.03	43.4	113.0	4.2
	12.0	5.1	11.8	1600	53.0	36.8	0.69	3.04	63.4	17.4	1600	58.7	3.61	46.4	103.0	4.8
80	6.0	1.3	2.9	1200	45.7	30.5	0.67	3.70	58.3	12.3	1200	58.3	4.05	44.5	114.0	4.2
	6.0	1.3	2.9	1600	47.6	34.5	0.72	3.85	60.8	12.3	1600	59.9	3.63	47.5	104.0	4.8
	9.0	2.6	6.1	1200	47.5	31.2	0.66	3.41	59.2	13.9	1200	61.2	4.12	47.1	116.0	4.3
	9.0	2.6	6.1	1600	49.5	35.3	0.71	3.55	61.6	13.9	1600	62.8	3.69	50.2	105.0	5.0
	12.0	4.9	11.4	1200	48.4	31.6	0.65	3.28	59.6	14.7	1200	62.6	4.16	48.4	117.0	4.4
	12.0	4.9	11.4	1600	50.4	35.7	0.71	3.41	62.1	14.8	1600	64.4	3.73	51.7	106.0	5.1
85	6.0	1.2	2.8	1200	44.3	29.9	0.67	3.93	57.7	11.3	1200	60.7	4.11	46.7	116.0	4.3
	6.0	1.2	2.8	1600	46.1	33.8	0.73	4.10	60.1	11.2	1600	62.5	3.69	49.9	105.0	5.0
	9.0	2.6	6.0	1200	46.2	30.6	0.66	3.63	58.6	12.7	1200	63.7	4.19	49.4	118.0	4.5
	9.0	2.6	6.0	1600	48.1	34.7	0.72	3.78	61.0	12.7	1600	65.5	3.75	52.7	107.0	5.1
	12.0	4.9	11.3	1200	47.1	31.0	0.66	3.48	59.0	13.5	1200	65.1	4.23	50.7	119.0	4.5
	12.0	4.9	11.3	1600	49.0	35.1	0.72	3.63	61.4	13.5	1600	67.0	3.79	54.1	108.0	5.2
90	6.0	1.2	2.8	1200	42.9	29.3	0.68	4.17	57.1	10.3	1200	63.3	4.18	49.0	117.0	4.4
	6.0	1.2	2.8	1600	44.6	33.2	0.74	4.34	59.4	10.3	1600	65.1	3.74	52.3	107.0	5.1
	9.0	2.6	5.9	1200	44.8	30.1	0.67	3.84	57.9	11.7	1200	66.3	4.26	51.7	120.0	4.6
	9.0	2.6	5.9	1600	46.6	34.1	0.73	4.01	60.3	11.6	1600	68.1	3.82	55.1	108.0	5.2
	12.0	4.8	11.1	1200	45.7	30.5	0.67	3.69	58.3	12.4	1200	67.7	4.30	53.0	121.0	4.6
	12.0	4.8	11.1	1600	47.6	34.5	0.72	3.85	60.8	12.3	1600	69.8	3.86	56.6	109.0	5.3
100	6.0	1.2	2.7	1200	39.8	28.2	0.71	4.70	55.9	8.5	Operation not recommended					
	6.0	1.2	2.7	1600	41.4	31.9	0.77	4.90	58.1	8.4						
	9.0	2.5	5.8	1200	41.8	28.9	0.69	4.34	56.6	9.6						
	9.0	2.5	5.8	1600	43.5	32.7	0.75	4.53	59.0	9.6						
	12.0	4.7	10.9	1200	42.8	29.3	0.68	4.17	57.0	10.3						
	12.0	4.7	10.9	1600	44.6	33.2	0.74	4.35	59.5	10.2						
110	6.0	1.1	2.6	1200	36.5	26.9	0.74	5.31	54.6	6.9	Operation not recommended					
	6.0	1.1	2.6	1600	38.0	30.4	0.80	5.53	56.9	6.9						
	9.0	2.4	5.6	1200	38.6	27.7	0.72	4.91	55.4	7.9						
	9.0	2.4	5.6	1600	40.2	31.4	0.78	5.12	57.7	7.8						
	12.0	4.6	10.6	1200	39.7	28.1	0.71	4.72	55.8	8.4						
	12.0	4.6	10.6	1600	41.3	31.8	0.77	4.92	58.1	8.4						
120	6.0	1.1	2.5	1200	33.0	25.5	0.77	6.00	53.5	5.5	Operation not recommended					
	6.0	1.1	2.5	1600	34.4	28.9	0.84	6.25	55.7	5.5						
	9.0	2.4	5.5	1200	35.2	26.4	0.75	5.56	54.2	6.3						
	9.0	2.4	5.5	1600	36.7	29.9	0.81	5.79	56.5	6.3						
	12.0	4.5	10.4	1200	36.3	26.8	0.74	5.35	54.6	6.8						
	12.0	4.5	10.4	1600	37.8	30.3	0.80	5.57	56.8	6.8						

Interpolation is permissible; extrapolation is not.
 All entering air conditions are 80°F DB and 67°F WB in cooling, and 70°F DB in heating.
 AHR/ISO certified conditions are 80.6°F DB and 66.2°F WB in cooling and 68°F DB in heating.
 Table does not reflect fan or pump power corrections for AHR/ISO conditions.
 All performance is based upon the lower voltage of dual voltage rated units.
 Performance stated is at the rated power supply; performance may vary as the power supply varies from the rated.
 Operation below 40°F EWT is based upon a 15% methanol antifreeze solution.
 Operation below 60°F EWT requires optional insulated water/refrigerant circuit.
 See performance correction tables for operating conditions other than those listed above.
 See Performance Data Selection Notes for operation in the shaded areas.

Performance Data – HBH/V 060 (PSC Blower)

2,000 CFM Nominal (Rated) Airflow

Performance capacities shown in thousands of Btu/h

EWT °F	GPM	WPD		Cooling - EAT 80/67°F							Heating - EAT 70°F					
		PSI	FT	Airflow CFM	TC	SC	Sens/Tot Ratio	kW	HR	EER	Airflow CFM	HC	kW	HE	LAT	COP
20	15.0	14.0	32.2	Operation not recommended							1460	41.6	4.98	25.8	96	2.45
	15.0	14.0	32.2	Operation not recommended							1950	42.6	4.48	27.5	90	2.79
30	7.5	3.4	7.9	1460	68.2	41.6	0.61	3.00	78.3	22.8	1460	45.5	5.08	29.2	99	2.62
	7.5	3.4	7.9	1950	71.0	47.0	0.66	3.12	81.6	22.8	1950	46.6	4.56	31.1	92	2.99
	11.3	6.8	15.8	1460	69.0	41.5	0.60	2.87	78.7	24.0	1460	47.4	5.13	30.9	100	2.71
	11.3	6.8	15.8	1950	71.8	47.0	0.65	2.99	82.0	24.0	1950	48.6	4.61	33.0	93	3.09
	15.0	12.6	29.2	1460	69.3	41.3	0.60	2.82	78.8	24.6	1460	48.5	5.16	31.8	101	2.75
	15.0	12.6	29.2	1950	72.1	46.8	0.65	2.94	82.1	24.6	1950	49.7	4.64	34.0	94	3.14
40	7.5	3.1	7.0	1460	66.6	41.1	0.62	3.21	77.4	20.8	1460	52.2	5.27	35.1	103	2.91
	7.5	3.1	7.0	1950	69.3	46.5	0.67	3.34	80.6	20.8	1950	53.5	4.73	37.5	95	3.31
	11.3	6.3	14.6	1460	67.8	41.5	0.61	3.05	78.1	22.2	1460	54.8	5.34	37.3	105	3.01
	11.3	6.3	14.6	1950	70.6	47.0	0.67	3.18	81.3	22.2	1950	56.1	4.80	39.8	97	3.43
	15.0	11.8	27.2	1460	68.3	41.6	0.61	2.98	78.4	22.9	1460	56.2	5.38	38.5	106	3.06
	15.0	11.8	27.2	1950	71.1	47.0	0.66	3.10	81.6	22.9	1950	57.5	4.83	41.1	97	3.49
50	7.5	2.8	6.4	1460	64.7	40.3	0.62	3.47	76.4	18.7	1460	59.5	5.48	41.4	108	3.18
	7.5	2.8	6.4	1950	67.3	45.6	0.68	3.61	79.6	18.7	1950	60.9	4.92	44.2	99	3.63
	11.3	5.9	13.7	1460	66.0	40.9	0.62	3.28	77.1	20.1	1460	62.6	5.57	44.1	110	3.29
	11.3	5.9	13.7	1950	68.7	46.3	0.67	3.41	80.3	20.1	1950	64.1	5.01	47.1	100	3.75
	15.0	11.1	25.7	1460	66.7	41.2	0.62	3.19	77.5	20.9	1460	64.3	5.63	45.6	111	3.35
	15.0	11.1	25.7	1950	69.4	46.6	0.67	3.32	80.7	20.9	1950	65.9	5.05	48.7	101	3.82
60	7.5	2.6	6.0	1460	62.4	39.3	0.63	3.78	75.3	16.5	1460	66.9	5.70	47.8	112	3.44
	7.5	2.6	6.0	1950	65.0	44.5	0.69	3.93	78.4	16.5	1950	68.5	5.12	51.0	103	3.92
	11.3	5.6	13.0	1460	63.7	39.9	0.63	3.56	75.8	17.9	1460	70.4	5.82	50.9	115	3.55
	11.3	5.6	13.0	1950	66.3	45.1	0.68	3.70	78.9	17.9	1950	72.1	5.22	54.4	104	4.05
	15.0	10.7	24.6	1460	64.2	40.0	0.62	3.45	75.9	18.6	1460	72.4	5.88	52.6	116	3.61
	15.0	10.7	24.6	1950	66.8	45.3	0.68	3.59	79.0	18.6	1950	74.1	5.28	56.2	105	4.12
70	7.5	2.4	5.6	1460	59.6	38.0	0.64	4.15	73.7	14.3	1460	74.2	5.93	54.1	117	3.66
	7.5	2.4	5.6	1950	62.0	43.0	0.69	4.32	76.7	14.3	1950	75.9	5.33	57.8	106	4.18
	11.3	5.4	12.5	1460	61.1	38.6	0.63	3.89	74.3	15.7	1460	78.0	6.05	57.5	119	3.78
	11.3	5.4	12.5	1950	63.6	43.7	0.69	4.05	77.4	15.7	1950	79.9	5.44	61.4	108	4.31
	15.0	10.3	23.7	1460	61.6	38.8	0.63	3.77	74.4	16.3	1460	80.1	6.12	59.2	121	3.84
	15.0	10.3	23.7	1950	64.2	43.9	0.68	3.92	77.5	16.3	1950	82.0	5.50	63.2	109	4.37
80	7.5	2.3	5.4	1460	56.4	36.7	0.65	4.59	72.1	12.3	1460	81.1	6.15	60.1	121	3.86
	7.5	2.3	5.4	1950	58.8	41.5	0.71	4.78	75.1	12.3	1950	83.0	5.52	64.2	109	4.41
	11.3	5.2	12.0	1460	58.1	37.3	0.64	4.29	72.7	13.5	1460	84.9	6.27	63.4	124	3.97
	11.3	5.2	12.0	1950	60.4	42.2	0.70	4.47	75.7	13.5	1950	87.0	5.63	67.7	111	4.52
	15.0	9.9	22.9	1460	58.7	37.5	0.64	4.15	72.8	14.1	1460	86.9	6.33	65.1	125	4.02
	15.0	9.9	22.9	1950	61.1	42.4	0.69	4.32	75.8	14.1	1950	89.0	5.69	69.5	112	4.58
85	7.5	2.3	5.2	1460	54.8	36.1	0.66	4.84	71.3	11.4	1460	84.1	6.25	62.8	123	3.95
	7.5	2.3	5.2	1950	57.0	40.8	0.72	5.04	74.2	11.4	1950	86.2	5.6	67.0	111	4.50
	11.3	5.1	11.8	1460	56.4	36.6	0.65	4.52	71.9	12.5	1460	87.8	6.4	65.9	126	4.04
	11.3	5.1	11.8	1950	58.7	41.4	0.70	4.71	74.8	12.5	1950	89.9	5.7	70.4	113	4.61
	15.0	9.8	22.6	1460	57.1	36.8	0.64	4.37	72.0	13.1	1460	89.6	6.4	67.5	127	4.09
	15.0	9.8	22.6	1950	59.5	41.6	0.70	4.55	75.0	13.1	1950	91.8	5.8	72.0	114	4.66
90	7.5	2.2	5.1	1460	53.1	35.4	0.67	5.09	70.5	10.4	1460	87.2	6.35	65.4	125	4.03
	7.5	2.2	5.1	1950	55.3	40.1	0.73	5.30	73.4	10.4	1950	89.3	5.70	69.9	112	4.59
	11.3	5.0	11.6	1460	54.8	35.9	0.66	4.76	71.0	11.5	1460	90.7	6.45	68.4	128	4.12
	11.3	5.0	11.6	1950	57.1	40.7	0.71	4.95	74.0	11.5	1950	92.9	5.80	73.1	114	4.70
	15.0	9.6	22.2	1460	55.5	36.1	0.65	4.60	71.2	12.1	1460	92.3	6.50	69.8	129	4.16
	15.0	9.6	22.2	1950	57.8	40.9	0.71	4.78	74.1	12.1	1950	94.5	5.84	74.5	115	4.74
100	7.5	2.1	4.9	1460	49.6	34.3	0.69	5.67	69.0	8.8	Operation not recommended					
	7.5	2.1	4.9	1950	51.7	38.9	0.75	5.90	71.9	8.8						
	11.3	4.9	11.3	1460	51.4	34.7	0.68	5.29	69.5	9.7						
	11.3	4.9	11.3	1950	53.5	39.3	0.73	5.51	72.3	9.7						
	15.0	9.4	21.7	1460	52.1	34.8	0.67	5.11	69.6	10.2						
	15.0	9.4	21.7	1950	54.2	39.4	0.73	5.32	72.4	10.2						
110	7.5	2.0	4.7	1460	46.6	33.8	0.73	6.33	68.2	7.4	Operation not recommended					
	7.5	2.0	4.7	1950	48.5	38.2	0.79	6.59	71.0	7.4						
	11.3	4.8	11.0	1460	47.8	33.6	0.70	5.91	68.0	8.1						
	11.3	4.8	11.0	1950	49.8	38.1	0.76	6.15	70.8	8.1						
	15.0	9.2	21.2	1460	48.6	33.7	0.69	5.71	68.2	8.5						
	15.0	9.2	21.2	1950	50.6	38.2	0.75	5.94	71.0	8.5						
120	7.5	2.0	4.6	1460	43.0	33.1	0.77	7.07	67.2	6.1	Operation not recommended					
	7.5	2.0	4.6	1950	44.7	37.5	0.84	7.36	70.0	6.1						
	11.3	4.7	10.7	1460	44.2	32.8	0.74	6.61	66.8	6.7						
	11.3	4.7	10.7	1950	46.0	37.1	0.81	6.88	69.6	6.7						
	15.0	9.0	20.7	1460	44.9	32.7	0.73	6.38	66.8	7.0						
	15.0	9.0	20.7	1950	46.8	37.0	0.79	6.64	69.5	7.0						

Interpolation is permissible; extrapolation is not.
 All entering air conditions are 80°F DB and 67°F WB in cooling, and 70°F DB in heating.
 AHRI/ISO certified conditions are 80.6°F DB and 66.2°F WB in cooling and 68°F DB in heating.
 Table does not reflect fan or pump power corrections for AHRI/ISO conditions.
 All performance is based upon the lower voltage of dual voltage rated units.
 Performance stated is at the rated power supply; performance may vary as the power supply varies from the rated.
 Operation below 40°F EWT is based upon a 15% methanol antifreeze solution.
 Operation below 60°F EWT requires optional insulated water/refrigerant circuit.
 See performance correction tables for operating conditions other than those listed above.
 See Performance Data Selection Notes for operation in the shaded areas.

Performance Data – HBH/V 060 (ECM Blower)

1750 CFM Nominal (Rated) Airflow

Performance capacities shown in thousands of Btu/h

EWT °F	GPM	WPD		Cooling - EAT 80/67°F							Heating - EAT 70°F					
		PSI	FT	Airflow CFM	TC	SC	Sens/Tot Ratio	kW	HR	EER	Airflow CFM	HC	kW	HE	LAT	COP
20	15.0	14.0	32.2	Operation not recommended							1460	42.0	4.7	25.8	92.0	2.6
	15.0	14.0	32.2								1950	42.0	4.2	27.5	87.0	2.9
30	7.5	3.4	7.9	1460	68.2	41.6	0.61	2.8	77.6	24.8	1460	45.7	4.8	29.2	95.0	2.8
	7.5	3.4	7.9	1950	71.0	47.0	0.66	2.9	80.8	24.7	1950	45.8	4.3	31.1	89.0	3.1
	11.3	6.8	15.8	1460	69.0	41.5	0.60	2.6	78.0	26.3	1460	47.6	4.9	30.9	96.0	2.9
	11.3	6.8	15.8	1950	71.8	47.0	0.65	2.7	81.2	26.2	1950	47.9	4.4	33.0	90.0	3.2
	15.0	12.6	29.2	1460	69.3	41.3	0.60	2.6	78.1	26.9	1460	48.6	4.9	31.8	97.0	2.9
	15.0	12.6	29.2	1950	72.1	46.8	0.65	2.7	81.3	26.7	1950	49.0	4.4	34.0	90.0	3.3
40	7.5	3.1	7.0	1460	66.6	41.1	0.62	3.0	76.7	22.5	1460	52.2	5.0	35.1	99.0	3.0
	7.5	3.1	7.0	1950	69.3	46.5	0.67	3.1	79.9	22.4	1950	52.8	4.5	37.5	92.0	3.5
	11.3	6.3	14.6	1460	67.8	41.5	0.61	2.8	77.4	24.2	1460	54.7	5.1	37.3	100.0	3.1
	11.3	6.3	14.6	1950	70.6	47.0	0.67	2.9	80.6	24.1	1950	55.3	4.6	39.8	93.0	3.6
	15.0	11.8	27.2	1460	68.3	41.6	0.61	2.7	77.6	25.0	1460	56.0	5.1	38.5	101.0	3.2
	15.0	11.8	27.2	1950	71.1	47.0	0.66	2.9	80.8	24.9	1950	56.7	4.6	41.1	94.0	3.6
50	7.5	2.8	6.4	1460	64.7	40.3	0.62	3.2	75.7	20.1	1460	59.3	5.2	41.4	103.0	3.3
	7.5	2.8	6.4	1950	67.3	45.6	0.68	3.4	78.8	20.0	1950	60.2	4.7	44.2	95.0	3.8
	11.3	5.9	13.7	1460	66.0	40.9	0.62	3.0	76.4	21.7	1460	62.3	5.3	44.1	104.0	3.4
	11.3	5.9	13.7	1950	68.7	46.3	0.67	3.2	79.5	21.7	1950	63.4	4.8	47.1	96.0	3.9
	15.0	11.1	25.7	1460	66.7	41.2	0.62	2.9	76.7	22.6	1460	64.0	5.4	45.6	105.0	3.5
	15.0	11.1	25.7	1950	69.4	46.6	0.67	3.1	79.9	22.6	1950	65.1	4.8	48.7	97.0	4.0
60	7.5	2.6	6.0	1460	62.4	39.3	0.63	3.5	74.5	17.7	1460	66.4	5.5	47.8	106.0	3.6
	7.5	2.6	6.0	1950	65.0	44.5	0.68	3.7	77.6	17.6	1950	67.6	4.9	51.0	98.0	4.1
	11.3	5.6	13.0	1460	63.7	39.9	0.63	3.3	75.0	19.2	1460	69.9	5.6	50.9	108.0	3.7
	11.3	5.6	13.0	1950	66.3	45.1	0.68	3.5	78.1	19.2	1950	71.4	5.0	54.4	99.0	4.2
	15.0	10.7	24.6	1460	64.2	40.0	0.62	3.2	75.1	20.0	1460	71.8	5.6	52.6	109.0	3.7
	15.0	10.7	24.6	1950	66.8	45.3	0.68	3.3	78.2	20.0	1950	73.4	5.0	56.2	100.0	4.3
70	7.5	2.4	5.6	1460	59.6	38.0	0.64	3.9	72.9	15.3	1460	73.5	5.7	54.1	110.0	3.8
	7.5	2.4	5.6	1950	62.0	43.0	0.69	4.1	75.9	15.2	1950	75.2	5.1	57.8	101.0	4.3
	11.3	5.4	12.5	1460	61.1	38.6	0.63	3.6	73.5	16.8	1460	77.3	5.8	57.5	112.0	3.9
	11.3	5.4	12.5	1950	63.6	43.7	0.69	3.8	76.6	16.7	1950	79.1	5.2	61.4	102.0	4.5
	15.0	10.3	23.7	1460	61.6	38.8	0.63	3.5	73.6	17.5	1460	79.2	5.9	59.2	113.0	4.0
	15.0	10.3	23.7	1950	64.2	43.9	0.68	3.7	76.7	17.5	1950	81.1	5.3	63.2	103.0	4.5
80	7.5	2.3	5.4	1460	56.4	36.7	0.65	4.3	71.2	13.0	1460	80.2	5.9	60.1	114.0	4.0
	7.5	2.3	5.4	1950	58.8	41.5	0.71	4.5	74.3	13.0	1950	82.2	5.3	64.2	104.0	4.6
	11.3	5.2	12.0	1460	58.1	37.3	0.64	4.0	71.9	14.4	1460	84.0	6.0	63.4	116.0	4.1
	11.3	5.2	12.0	1950	60.4	42.2	0.70	4.2	74.8	14.3	1950	86.1	5.4	67.7	105.0	4.7
	15.0	9.9	22.9	1460	58.7	37.5	0.64	3.9	72.0	15.0	1460	85.9	6.1	65.1	117.0	4.1
	15.0	9.9	22.9	1950	61.1	42.4	0.69	4.1	75.0	15.0	1950	88.1	5.4	69.5	106.0	4.7
85	7.5	2.3	5.2	1460	54.8	36.1	0.66	4.6	70.5	11.9	1460	83.3	6.0	62.8	116.0	4.1
	7.5	2.3	5.2	1950	57.0	40.8	0.72	4.8	73.4	11.9	1950	85.3	5.4	67.0	105.0	4.7
	11.3	5.1	11.8	1460	56.4	36.6	0.65	4.3	71.0	13.2	1460	86.9	6.2	65.9	118.0	4.1
	11.3	5.1	11.8	1950	58.7	41.4	0.71	4.5	73.9	13.1	1950	89.0	5.5	70.4	107.0	4.8
	15.0	9.8	22.6	1460	57.1	36.8	0.64	4.1	71.2	13.8	1460	88.5	6.2	67.5	119.0	4.2
	15.0	9.8	22.6	1950	59.5	41.6	0.70	4.3	74.2	13.8	1950	91.0	5.6	72.0	108.0	4.8
90	7.5	2.2	5.1	1460	53.1	35.4	0.67	4.8	69.6	11.0	1460	86.2	6.1	65.4	117.0	4.1
	7.5	2.2	5.1	1950	55.3	40.1	0.73	5.1	72.5	10.9	1950	88.5	5.5	69.9	107.0	4.8
	11.3	5.0	11.6	1460	54.8	35.9	0.66	4.5	70.2	12.1	1460	89.6	6.2	68.4	120.0	4.2
	11.3	5.0	11.6	1950	57.1	40.7	0.71	4.7	73.2	12.1	1950	92.1	5.6	73.1	108.0	4.9
	15.0	9.6	22.2	1460	55.5	36.1	0.65	4.4	70.4	12.7	1460	91.1	6.3	69.8	121.0	4.3
	15.0	9.6	22.2	1950	57.8	40.9	0.71	4.5	73.3	12.7	1950	93.6	5.6	74.5	109.0	4.9
100	7.5	2.1	4.9	1460	49.6	34.3	0.69	5.4	68.1	9.1	Operation not recommended					
	7.5	2.1	4.9	1950	51.7	38.9	0.75	5.7	71.0	9.1						
	11.3	4.9	11.3	1460	51.4	34.7	0.68	5.0	68.6	10.2						
	11.3	4.9	11.3	1950	53.5	39.3	0.73	5.3	71.5	10.2						
	15.0	9.4	21.7	1460	52.1	34.8	0.67	4.9	68.7	10.7						
	15.0	9.4	21.7	1950	54.2	39.4	0.73	5.1	71.5	10.7						
110	7.5	2.0	4.7	1460	46.6	33.8	0.73	6.1	67.4	7.7	Operation not recommended					
	7.5	2.0	4.7	1950	48.5	38.2	0.79	6.3	70.2	7.6						
	11.3	4.8	11.0	1460	47.8	33.6	0.70	5.7	67.1	8.4						
	11.3	4.8	11.0	1950	49.8	38.1	0.77	5.9	69.9	8.4						
	15.0	9.2	21.2	1460	48.6	33.7	0.69	5.5	67.2	8.9						
	15.0	9.2	21.2	1950	50.6	38.2	0.75	5.7	70.0	8.9						
120	7.5	2.0	4.6	1460	43.0	33.1	0.77	6.8	66.3	6.3	Operation not recommended					
	7.5	2.0	4.6	1950	44.7	37.5	0.84	7.1	69.0	6.3						
	11.3	4.7	10.7	1460	44.2	32.8	0.74	6.4	65.9	6.9						
	11.3	4.7	10.7	1950	46.0	37.1	0.81	6.6	68.6	6.9						
	15.0	9.0	20.7	1460	44.9	32.7	0.73	6.1	65.8	7.3						
	15.0	9.0	20.7	1950	46.8	37.0	0.79	6.4	68.6	7.3						

Interpolation is permissible; extrapolation is not.
 All entering air conditions are 80°F DB and 67°F WB in cooling, and 70°F DB in heating.
 AHRI/ISO certified conditions are 80.6°F DB and 66.2°F WB in cooling and 68°F DB in heating.
 Table does not reflect fan or pump power corrections for AHRI/ISO conditions.
 All performance is based upon the lower voltage of dual voltage rated units.
 Performance stated is at the rated power supply; performance may vary as the power supply varies from the rated.
 Operation below 40°F EWT is based upon a 15% methanol antifreeze solution.
 Operation below 60°F EWT requires optional insulated water/refrigerant circuit.
 See performance correction tables for operating conditions other than those listed above.
 See Performance Data Selection Notes for operation in the shaded areas.

Air Flow Correction Table

Cooling Corrections												
Ent Air WB °F	Total Clg Cap	Sens Clg Cap Multipliers - Entering DB °F								Power	Heat of Rejection	
		65	70	75	80	80.6	85	90	95			
50	0.7800	0.9778	*	*	*	*	*	*	*	0.9972	0.8243	
55	0.8327	0.8966	1.0556	*	*	*	*	*	*	0.9980	0.8667	
60	0.8954	0.7505	0.9184	1.1056	*	*	*	*	*	0.9988	0.9169	
65	0.9681		0.6778	0.8992	1.1213	1.1480	1.3439	*	*	0.9996	0.9747	
66.2	0.9871		0.6103	0.8420	1.0698	1.0969	1.2938	*	*	0.9999	0.9897	
67	1.0000		0.5507	0.7782	1.0000	1.0262	1.2161	1.4266	*	1.0000	1.0000	
70	1.0508			0.6408	0.8856	0.9135	1.1082	1.3087	1.4869	1.0005	1.0403	
75	1.1435		Operation not recommended			0.6085	0.6403	0.8566	1.0663	1.2376	1.0014	1.1135

* Sensible capacity equals total capacity.
 AHRI/ISO/ASHRAE 13256-1 uses entering air conditions of Cooling - 80.6°F DB/ 66.2°F WB, and Heating - 68°F DB/ 59°F WB entering air temperature.

Heating Corrections			
Ent Air DB °F	Heating Capacity	Heating Power	Heat of Extraction
45	1.0507	0.7802	1.1314
50	1.0327	0.8227	1.0953
55	1.0195	0.8683	1.0646
60	1.0102	0.9168	1.0380
65	1.0033	0.9680	1.0139
68	1.0000	1.0000	1.0000
70	0.9979	1.0218	0.9908
75	0.9928	1.0781	0.9673
80	0.9866	1.1367	0.9419

Air Flow Correction Table

Airflow	Heating			Cooling				
	% of Rated	Heating Capacity	Heating Power	Heat of Extraction	Total Capacity	Sensible Capacity	Sens/Total Ratio	Power
75	0.9764	1.1134	0.9368	0.9605	0.8837	0.9200	0.9606	0.9605
81.25	0.9829	1.0789	0.9551	0.9730	0.9130	0.9384	0.9691	0.9722
87.5	0.9889	1.0484	0.9717	0.9837	0.9393	0.9548	0.9784	0.9826
93.75	0.9947	1.0222	0.9867	0.9927	0.9668	0.9739	0.9887	0.9919
100	1.0000	1.0000	1.0000	1.0000	1.0000	1.0000	1.0000	1.0000
106.25	1.0050	0.9820	1.0116	1.0055	1.0434	1.0377	1.0122	1.0069
112.5	1.0096	0.9681	1.0216	1.0093	1.1016	1.0915	1.0253	1.0126
118.75	1.0138	0.9583	1.0299	1.0113	1.1790	1.1658	1.0394	1.0171
125	1.0177	0.9527	1.0365	1.0116	1.2798	1.2652	1.0544	1.0204

Antifreeze Correction Table

Antifreeze Type	Antifreeze %	Cooling			Heating		WPD Corr. Fct. EWT 30°F
		EWT 90°F			EWT 30°F		
		Total Cap	Sens Cap	Power	Htg Cap	Power	
Water	0	1.000	1.000	1.000	1.000	1.000	1.000
Propylene Glycol	5	0.995	0.995	1.003	0.989	0.997	1.070
	15	0.986	0.986	1.009	0.968	0.990	1.210
	25	0.978	0.978	1.014	0.947	0.983	1.360
Methanol	5	0.997	0.997	1.002	0.989	0.997	1.070
	15	0.990	0.990	1.007	0.968	0.990	1.160
	25	0.982	0.982	1.012	0.949	0.984	1.220
Ethanol	5	0.998	0.998	1.002	0.981	0.994	1.140
	15	0.994	0.994	1.005	0.944	0.983	1.300
	25	0.986	0.986	1.009	0.917	0.974	1.360
Ethylene Glycol	5	0.998	0.998	1.002	0.993	0.998	1.040
	15	0.994	0.994	1.004	0.980	0.994	1.120
	25	0.988	0.988	1.008	0.966	0.990	1.200

Blower Performance Data – Standard Unit – PSC

Airflow in CFM with wet coil and clean air filter

Model	Fan Speed	Rated Airflow	Min CFM	Airflow (cfm) at External Static Pressure (in. wg)																																		
				0.00	0.05	0.10	0.15	0.20	0.25	0.30	0.35	0.40	0.45	0.50	0.60	0.70	0.80	0.90	1.00																			
HBH/V 006	HI	220	150													Operation not recommended																						
	MED																																					
	LOW																																					
HBH/V 009	HI	325	225													310	300	290	280	270	250	230	210	180														
	MED															260	250	240	230	210	200	190	150															
	LOW															210	200	190	180	160	150																	
HBH/V 012	HI	400	300													410	400	380	360	350	330					320	300	280										
	MED															390	370	360	340	320	310					290	280	260										
	LOW															340	330	322	310	300	280	260	250															
HBH/V 015	HI	525	375													470	460	450	440	430	420	400	390					380	320									
	MED															420	410	400	390	380	370	360	350					340										
	LOW															360	360	350	340	320	320	310	300															
HBH/V 018	HI	600	450													745	725	706	696	686	666	637	588					539	451									
	MED															686	676	666	657	647	637	617	608					588	549					510				
	LOW															608	598	588	578	568	559	549	529	510	480	451												
HBH/V 024	HI	800	600													745	725	706	696	686	666	637	588	539	451													
	MED															960	950	941	931	912	893	874	855	836	817						789	732	665					
	LOW															779	770	760	751	741	732	722	713	694	684					665	618							
HBH/V 030	HI	1000	750													1102	1074	1045	1017	979	903	798																
	MED															1188	1169	1140	1121	1093	1064	1036					1017	988	960	922	846							
	LOW															1064	1045	1017	998	979	960	931					912	884	855	827	751							
HBH/V 036	HI	1200	900													1474	1455	1436	1416	1387	1358	1329	1310	1280	1232	1174	1077	931										
	MED															1174	1164	1106	1106	1096	1096	1086	1077	1067	1038	1009	912											
	LOW															980	980	970	970	960	960	951	951	941	922	902												
HBH 041	HI	1325	950													1328	1300	1269	1235	1198	1157	1114	1067	1018	965													
	MED															1181	1164	1142	1118	1090	1058	1023	985															
	LOW															1031	1021	1008	991	971	947																	
HBH/V 042	HI	1350	1050													1558	1530	1501	1473	1444	1416							1378	1340	1302	1264	1226	1131					
	MED															1416	1397	1368	1349	1321	1302					1273	1245	1207	1169	1131	1064							
	LOW															1083	1083	1074	1074	1064	1055																	
HBH/V 048	HI	1600	1200													1881	1853	1815	1767	1710	1653					1596	1416	1216	1216									
	MED															1843	1824	1805	1786	1767	1729					1682	1653	1625	1577					1520	1340			
	LOW															1682	1663	1644	1625	1606	1587	1568	1530	1492	1435	1378	1264											
HBH/V 060	HI	2000	1500													2195	2195	2185	2176	2156	2117	2078	2048	2019	1999	1970	1921					1842	1754	1627				
	MED															2009	2009	1999	1980	1950	1931	1901	1882	1852	1823	1793	1744					1676	1588					
	LOW															1813	1813	1803	1793	1774	1764	1744	1725	1695	1666	1637	1568											

Black areas denote ESP where operation is not recommended.
 Units factory shipped on medium speed. Other speeds require field selection.
 All airflow is rated and shown above at the lower voltage if unit is dual voltage rated, e.g. 208V for 208-230V units.
 Only two speed fan (H & M) available on 575V units.
 Performance stated is at the rated power supply, performance may vary as the power supply varies from the rated.

Blower Performance Data – High Static – PSC

Model	Fan Speed	Rated Airflow	Min CFM	Airflow (cfm) at External Static Pressure (in. wg)																		
				0.00	0.05	0.10	0.15	0.20	0.25	0.30	0.35	0.40	0.45	0.50	0.60	0.70	0.80	0.90	1.00			
HBH/V 015	HS HI	525	375	Operation not recommended				774	764	755	745	735	715	696	676	637	519	Operation not recommended				
	HS MED			735	725	706	696	686	676	657	657	647	637	617	588	480	Operation not recommended					
	HS LOW			657	647	627	617	608	598	588	578	568	568	559	519	Operation not recommended						
HBH/V 018	HS HI	600	450	Operation not recommended				774	764	755	745	735	715	696	676	637	519	Operation not recommended				
	HS MED			735	725	706	696	686	676	657	657	647	637	617	588	480	Operation not recommended					
	HS LOW			657	647	627	617	608	598	588	578	568	568	559	519	Operation not recommended						
HBH/V 024	HS HI	800	600	Operation not recommended										979	903	798	665	Operation not recommended				
	HS MED			Operation not recommended										988	960	922	846	713	Operation not recommended			
	HS LOW			979	960	931	912	884	855	827	751	675	Operation not recommended									
HBH/V 030	HS HI	1000	750	Operation not recommended										1102	988	874	760	Operation not recommended				
	HS MED			Operation not recommended										1074	1026	979	884	779	Operation not recommended			
	HS LOW			998	988	979	960	941	931	912	893	865	836	798	Operation not recommended							
HBH/V 036	HS HI	1200	900	Operation not recommended										1484	1455	1426	1358	1251	1135	931		
	HS MED			1319	1310	1300	1290	1280	1271	1261	1242	1222	1213	1193	1116	1038	Operation not recommended					
	HS LOW			999	989	980	980	970	970	960	951	931	922	902	Operation not recommended							
HBH/V 042	HS HI	1350	1050	Operation not recommended										1473	1463	1444	1425	1397	1387	1378	1311	1178
	HS MED			1321	1311	1302	1292	1283	1273	1254	1245	1235	1216	1188	1121	Operation not recommended						
	HS LOW			Operation not recommended										Operation not recommended								
HBH/V 048	HS HI	1600	1200	Operation not recommended										1957	1938	1910	1862	1786	1701	1577	1435	
	HS MED			1948	1948	1938	1919	1891	1872	1843	1824	1796	1767	1739	1691	1625	1539	1416	1254			
	HS LOW			1758	1758	1748	1739	1720	1710	1691	1672	1644	1615	1587	1520	1435	1311	Operation not recommended				
HBH/V 060	HS HI	2000	1500	2352	2352	2342	2332	2323	2313	2293	2274	2254	2225	2195	2156	2087	2019	1940	1852			
	HS MED			2117	2117	2107	2107	2097	2068	2038	2019	1999	1989	1980	1940	1891	1842	1460	1715			
	HS LOW			1891	1891	1882	1882	1872	1862	1852	1852	1842	1833	1813	1793	1764	1715	1666	1588			

Black areas denote ESP where operation is not recommended.

Units factory shipped on medium speed. Other speeds require field selection.

All airflow is rated and shown above at the lower voltage if unit is dual voltage rated, e.g. 208V for 208-230V units.

Only two speed fan (H & M) available on 575V units.

Performance stated is at the rated power supply, performance may vary as the power supply varies from the rated.

Blower Performance Data (ECM Motor)

Airflow in CFM with wet coil and clean air filter

Model	Max ESP (in. wg)	Fan Motor (hp)	Tap Setting	Cooling Mode			Dehumid Mode			Heating Mode		
				Stg 1	Stg 2	Fan	Stg 1	Stg 2	Fan	Stg 1	Stg 2	Fan
HB 015	0.50	1/3	4	470	550	275	376	440	275	470	550	275
	0.50		3	425	500	250	340	400	250	425	500	250
	0.50		2	380	450	225	304	360	225	380	450	225
	0.50		1	340	400	200				340	400	200
HB 018	0.50	1/3	4	550	650	325	440	520	325	550	650	325
	0.50		3	510	600	300	408	480	300	510	600	300
	0.50		2	465	550	275	372	440	275	465	550	275
	0.50		1	425	500	250				425	500	250
HB 024	0.50	1/2	4	745	875	438	596	700	438	745	875	438
	0.50		3	680	800	400	544	640	400	680	800	400
	0.50		2	615	725	363	492	580	363	615	725	363
	0.50		1	550	650	325				550	650	325
HB 030	0.50	1/2	4	890	1050	525	712	840	525	890	1050	525
	0.50		3	810	950	475	648	760	475	810	950	475
	0.50		2	745	875	438	596	700	438	745	875	438
	0.50		1	680	800	400				680	800	400
HB 036	0.50	3/4	4	1085	1275	638	868	1020	638	1085	1275	638
	0.50		3	1020	1200	600	816	960	600	1020	1200	600
	0.50		2	955	1125	563	764	900	563	955	1125	563
	0.50		1	850	1000	500				850	1000	500
HB 042	0.50	3/4	4	1255	1475	738	1004	1180	738	1255	1475	738
	0.50		3	1120	1320	660	896	1056	660	1120	1320	660
	0.50		2	1020	1200	600	816	960	600	1020	1200	600
	0.50		1	935	1100	550				935	1100	550
HB 048	0.75	1	4	1445	1700	850	1156	1360	850	1445	1700	850
	0.75		3	1275	1500	750	1020	1200	750	1275	1500	750
	0.75		2	1190	1400	700	952	1120	700	1190	1400	700
	0.75		1	1105	1300	650				1105	1300	650
HB 060	0.75	1	4	1740	2050	1025	1392	1640	1025	1740	2050	1025
	0.75		3	1615	1900	950	1292	1520	950	1615	1900	950
	0.75		2	1490	1750	875	1192	1400	875	1490	1750	875
	0.75		1	1360	1600	800				1360	1600	800

See ECM control section for details on setting taps.
 Airflow is controlled within 5% up to the Max ESP shown with wet coil.
 Do not select Dehumidification mode if HP CFM is on setting 1.

ECM Control

The ECM fan is controlled by an interface board that converts thermostat inputs and field selectable CFM settings to signals used by the ECM motor controller. Fan speeds are selected with DIP switch settings. To take full advantage of the ECM motor features, a multi-stage thermostat should be used (2-stage heat/2-stage cool or 3-stage heat/2-stage cool).

Note: Power must be off to the unit for at least three seconds before the ECM motor will recognize a speed change. The motor will recognize a change in the CFM Adjust or dehumidification mode settings while the unit is powered.

There are four different airflow settings from lowest airflow rate (speed tap 1) to the highest airflow rate (speed tap 4). The charts below indicate settings for the ECM interface board, followed by detailed information for each setting.

Cooling Settings: The cooling setting determines the cooling (normal) CFM for all units with ECM motor. Cooling (normal) setting is used when the unit is not in dehumidification mode. Tap 1 is the lowest CFM setting, while tap 4 is the highest CFM setting. To avoid air coil freeze-up, tap 1 may not be used if the dehumidification mode is selected. Consult submittal data or specifications catalog for the specific unit series and model to correlate speed tap setting to airflow in CFM.

Tap 1 is the lowest CFM setting, while tap 4 is the highest CFM setting. Consult submittal data or specifications catalog for the specific unit series and model to correlate speed tap setting to airflow in CFM.

CFM Adjust Settings: The CFM adjust setting allows four selections. The NORM setting is the factory default position. The + or – settings adjust the airflow by +/- 5%. The +/- settings are used to “fine tune” airflow adjustments. The TEST setting runs the ECM motor at 400 cfm/ton, which causes the motor to operate like a standard PSC motor, and disables the CFM counter.

Dehumidification Mode Settings: The dehumidification mode setting provides field selection of humidity control. When operating in the normal mode, the cooling airflow settings are determined by the cooling tap setting above. When dehumidification is enabled there is a reduction in airflow in cooling to increase the moisture removal of the heat pump. Consult submittal data or specifications catalog for the specific unit series and model to correlate speed tap to airflow in CFM. The dehumidification mode can be enabled in two ways.

1. Constant Dehumidification Mode: When the dehumidification mode is selected (via DIP switch or

Cooling settings

Tap Setting	DIP Switch	
	SW1	SW2
1	ON	ON
2	ON	OFF
3	OFF	ON
4	OFF	OFF

Heating settings

Tap Setting	DIP Switch	
	SW3	SW4
1	ON	ON
2	ON	OFF
3	OFF	ON
4	OFF	OFF

CFM Adjust settings

Tap Setting	DIP Switch	
	SW7	SW8
TEST	ON	ON
-	ON	OFF
+	OFF	ON
NORM	OFF	OFF

Dehum Mode settings

Tap Setting	DIP Switch
	SW9
NORM	ON
Dehumid	OFF

Only DIP switch numbers 1 to 4 and 7 to 9 are used.

WARNING!

WARNING! When the disconnect switch is closed, high voltage is present in some areas of the electrical panel. Exercise caution when working with energized equipment.

ECM Control

jumper setting), the ECM motor will operate with a multiplier applied to the cooling CFM settings (approx. 20-25% lower airflow). Any time the unit is running in the cooling mode, it will operate at the lower airflow to improve latent capacity. The "DEHUM" LED will be illuminated at all times. Heating airflow is not affected. NOTE: Do not select dehumidification mode if cooling setting is tap 1.

- Automatic (Humidistat-controlled) Dehumidification Mode: When the dehumidification mode is selected (via DIP switch or jumper setting) AND a humidistat is connected to terminal DH (version II) or HUM (version I), the cooling airflow will only be reduced when the humidistat senses that additional dehumidification is required. The DH (or HUM) terminal is reverse logic. Therefore, a humidistat (not dehumidistat) is required. The "DEHUM" LED will be illuminated only when the humidistat is calling for dehumidification mode. Heating airflow is not affected. NOTE: Do not select dehumidification mode if cooling setting is tap 1.

The ECM motor includes "soft start" and "ramp down" features. The soft start feature is a gentle increase of motor rpm at blower start up. This creates a much quieter blower start cycle.

The ramp down feature allows the blower to slowly decrease rpm to a full stop at the end of each blower cycle. This creates a much quieter end to each blower cycle and adds overall unit efficiency.

The ramp down feature may be eliminated during an ESD (Emergency Shut Down) situation when using a DXM unit controller. A DPDT relay is required to break the line voltage to the ECM motor during ESD. This relay can be wired as shown below to eliminate the ramp down (and operation) of the ECM blower motor.

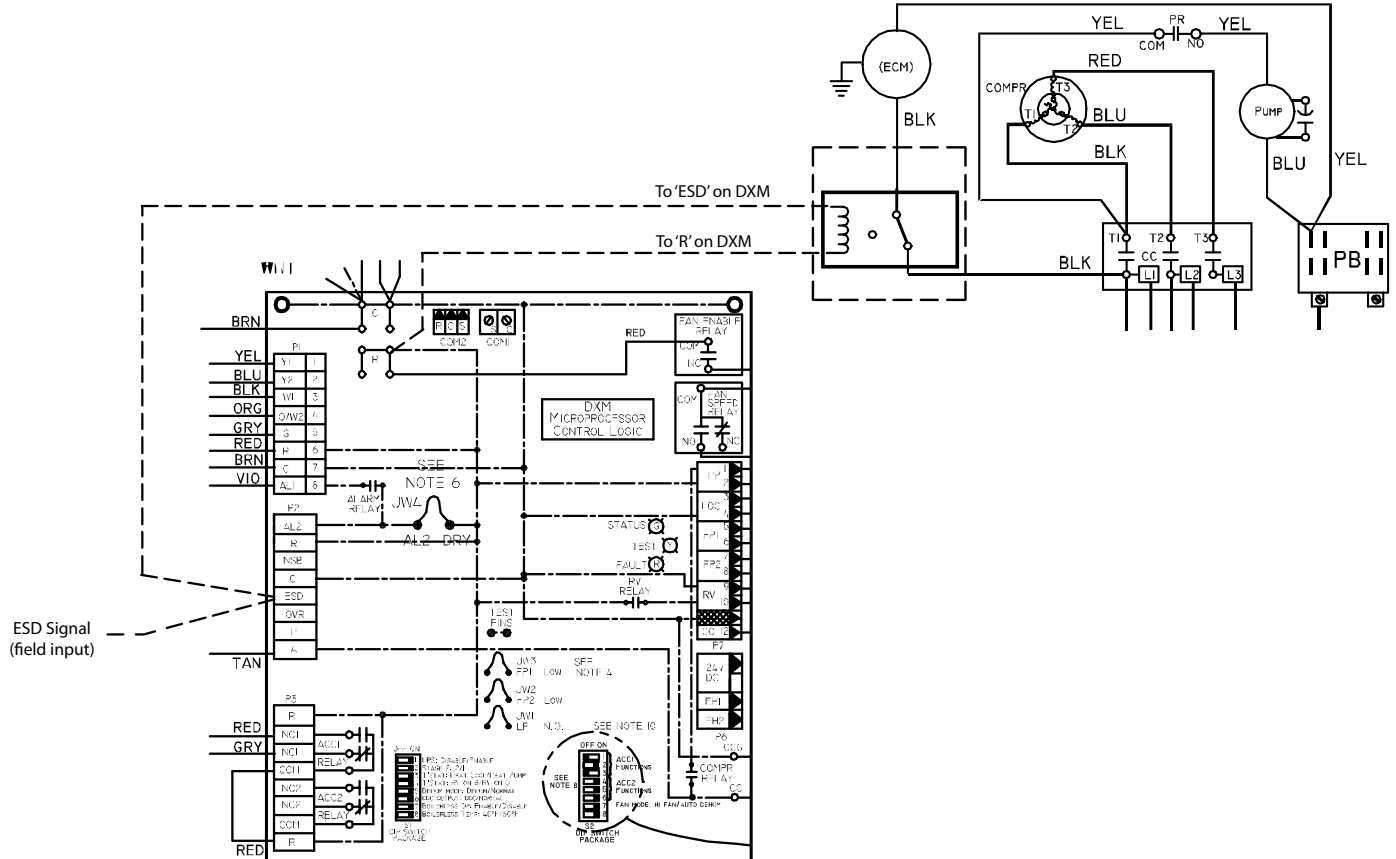

Physical Data

HB Series	006	009	012	015	018	024	030	036	041	042	048	060
Compressor (1 Each)	Rotary						Scroll					
Factory Charge HFC-410A (oz)	17	18.5	23	32	43	40	47	50	70	70	74	82
ECM Fan Motor & Blower												
Blower Wheel Size (Dia x w)	N/A	N/A	N/A	9x7	9x7	9x7	9x7	9x8	N/A	9x8	10x10	11x10
PSC Fan Motor & Blower												
Fan Motor Type/Speeds	PSC/3	PSC/3	PSC-3	PSC/3	PSC/3	PSC/3	PSC/3	PSC/3	PSC/3	PSC/3	PSC/3	PSC/3
Blower Wheel Size (Dia x w)	5x5	5x5	6x5	8x7	8x7	9x7	9x7	9x8	9x8	9x8	10x10	11x10
Water Connection Size												
FPT	1/2"	1/2"	1/2"	1/2"	1/2"	3/4"	3/4"	3/4"	3/4"	3/4"	1"	1"
Coax Volume (gallons)	0.123	0.143	0.167	0.286	0.450	0.286	0.323	0.323	0.890	0.890	0.738	0.939
Vertical												
Air Coil Dimensions (H x W)	10x15	10x15	10x15	20x17.25	20x17.25	20x17.25	20x17.25	24x21.75	20x17.25	24x21.76	24x28.25	24x28.25
Filter Standard - 1" Throwaway	10x18	10x18	10x18	20x20	20x20	20x20	20x20	24x24	20x20	24x24	1-14x24, 1-18x24	1-14x24, 1-18x24
Weight - Operating (lbs.)	103	105	114	153	158	189	197	203	210	218	263	278
Weight - Packaged (lbs.)	113	115	124	158	163	194	202	209	217	224	270	285
Horizontal												
Air Coil Dimensions (H x W)	10x15	10x15	10x15	16x22	16x22	16x22	16x22	20x25	N/A	20x25	20x35	20x35
Filter Standard - 1" Throwaway	10x18	10x18	10x18	16x25	16x25	18x25	18x25	20x28 or 2-20x14	N/A	20x28 or 2-20x14	1-20x24, 1-20x14	1-20x24, 1-20x14
Weight - Operating (lbs.)	103	105	114	153	158	174	182	203	N/A	218	263	278
Weight - Packaged (lbs.)	113	115	124	158	163	179	187	209	N/A	224	270	285

Notes:

All units have TXV expansion device, and 1/2" & 3/4" electrical knockouts.

FPT = Female Pipe Thread

Condensate Drain Connection is 3/4" FPT.

575 volt fan motors are two speed.

Unit Maximum Water Working Pressure	Max Pressure PSIG [kPa]
Base Unit	500 [3447]

HB - Horizontal – Dimensional Data

Horizontal Model		Overall Cabinet			Horizontal Model		Electrical Knockouts		
		A Width	B Length	C Height			H 1/2"	J 1/2"	K 3/4"
006 - 012	in	19.1	34.1	11.1	006 - 012	in	Low Voltage	Low Voltage	Power Supply
	cm	48.5	86.6	28.2			8.1	5.1	2.1
015 - 018	in	20.1	43.1	17.0	015 - 030	in	30.8	23.2	6.1
	cm	51.1	109.5	43.2			12.1	9.1	15.6
024 - 030	in	20.1	43.1	18.3	036 - 042	in	41.0	33.3	10.1
	cm	51.1	109.5	46.5			16.1	13.1	25.7
036 - 042	in	20.1	47.1	21.0	048 - 060	in	41.0	33.3	10.1
	cm	51.1	119.6	53.3			16.1	13.1	25.7
048 - 060	in	24.1	54.1	21.0					
	cm	61.2	137.4	53.3					

Horizontal Model		Water Connections							Loop In/Out FPT
		①		②		③			
		Loop In D	Loop In E	Loop Out F	Loop Out G	Cond. 3/4" FPT			
					AA	BB			
006 - 012	in	9.6	1.1	1.5	1.1	3.3	0.7	1/2"	
	cm	24.3	2.7	3.8	2.7	8.4	1.8		
015	in	15.1	1.4	3.2	1.4	3.3	0.7	1/2"	
	cm	38.4	3.4	8.1	3.5	8.4	1.8		
018	in	15.1	1.4	4.1	1.4	3.3	0.7	1/2"	
	cm	38.4	3.4	10.4	3.5	8.4	1.8		
024	in	16.4	1.4	4.4	1.4	3.3	0.7	3/4"	
	cm	41.7	3.4	11.3	3.5	8.4	1.8		
030	in	16.4	1.4	3.1	1.4	3.3	0.7	3/4"	
	cm	41.7	3.4	7.8	3.5	8.4	1.8		
036	in	19.1	1.4	5.3	1.4	3.3	0.7	3/4"	
	cm	48.5	3.4	13.4	3.5	8.4	1.8		
042	in	19.1	1.4	4.4	1.4	3.3	0.7	3/4"	
	cm	48.5	3.4	11.3	3.5	8.4	1.8		
048	in	19.1	1.4	4.4	1.4	3.3	0.7	1"	
	cm	48.5	3.4	11.1	3.5	8.4	1.8		
060	in	19.1	1.4	3.8	1.4	3.3	0.7	1"	
	cm	48.5	3.4	9.7	3.5	8.4	1.8		

Horizontal Model		Discharge Connection Duct Flange Installed (+/- 0.10 in, +/- 2.5mm)					Return Connection Using Return Air Opening			
		L	M Supply Height	N Supply Width	O	P	Q Return Width	R Return Height	S	T
006 - 012	in	0.8	8.9	6.7	5.2	1.3	16.1	9.8	1.1	0.6
	cm	1.9	22.7	17.0	13.3	3.3	41.0	25.0	2.7	1.5
015 - 018	in	2.6	13.3	9.9	4.1	1.3	23.0	15.0	1.1	1.0
	cm	6.6	33.8	25.1	10.5	3.3	58.4	38.1	2.8	2.5
024 - 030	in	2.6	13.3	9.9	4.1	1.3	23.0	16.3	1.1	1.0
	cm	6.6	33.8	25.1	10.5	3.3	58.4	41.4	2.8	2.5
036 - 042	in	2.5	16.1	11.0	3.0	2.5	25.9	19.0	1.1	1.0
	cm	6.3	40.9	27.9	7.7	6.4	65.8	48.3	2.8	2.5
048	in	3.7	16.1	13.7	4.1	1.3	35.9	19.0	1.1	1.0
	cm	9.5	41.0	34.8	10.3	3.2	91.2	48.3	2.8	2.5
060	in	1.7	18.1	13.7	4.1	1.3	35.9	19.0	1.1	1.0
	cm	4.4	46.0	34.8	10.3	3.2	91.2	48.3	2.8	2.5

HB - Horizontal – Dimensional Data

LEFT RETURN

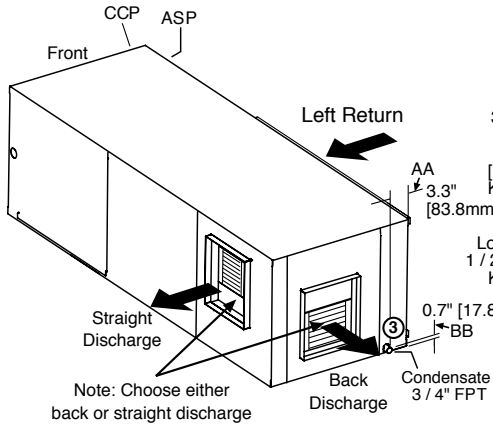

Note: Choose either back or straight discharge

RIGHT RETURN

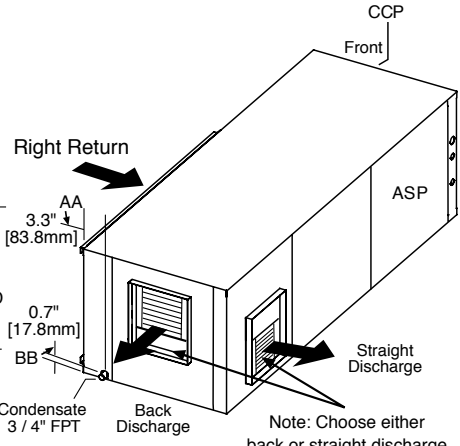

Note: Choose either back or straight discharge

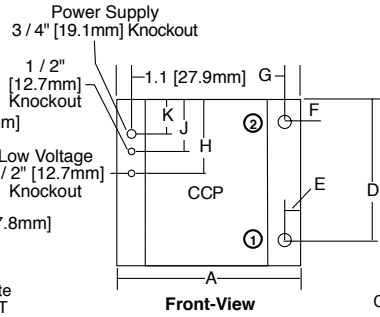

Front-View

Note: Blower service panel requires 2' service access

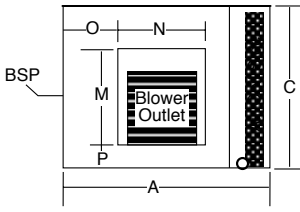

Left Return Back Discharge

Unit Hanger Detail				
Model	U	V	W	
006-012	34.1 [86.6]	21.1 [53.6]	16.9 [42.9]	
015-030	43.1 [109.5]	22.2 [56.4]	18.0 [45.7]	
036-042	47.1 [119.6]	22.2 [56.4]	18.0 [45.7]	
048-060	54.1 [137.4]	26.2 [66.5]	22.0 [55.9]	

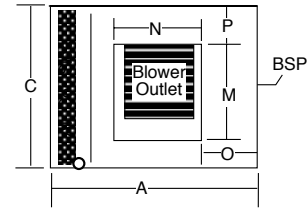

Right Return Back Discharge

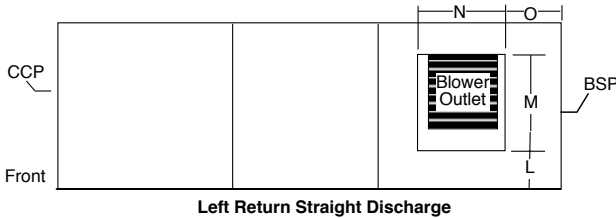

Left Return Straight Discharge

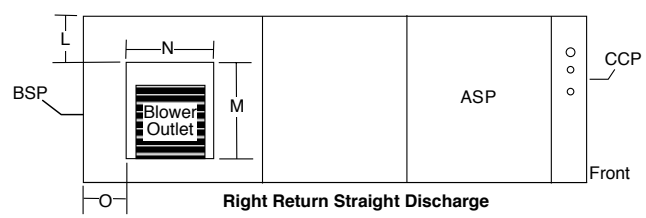

Right Return Straight Discharge

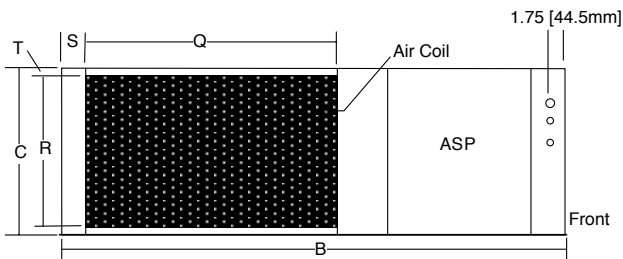

Left Return Left View - Air Coil Opening

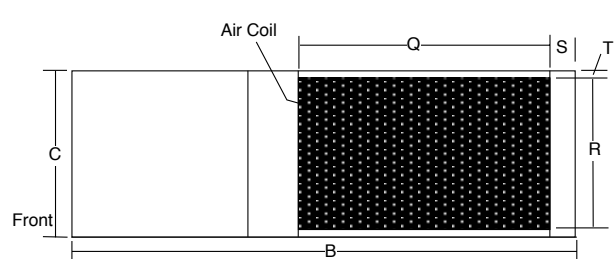

Right Return Right View - Air Coil Opening

Notes:

1. While clear access to all removable panels is not required, installer should take care to comply with all building codes and allow adequate clearance for future field service.
2. Units shipped with filter rails. These rails should be removed for return duct connection. See Aff---- for accessory air filter frame with duct collar.
3. Discharge flange and hanger brackets are factory installed.
4. Condensate is 3/4" FPT.
5. Blower service panel requires 2' service access.
6. Blower service access is through back panel on straight discharge units or through panel opposite air coil on back discharge units

Legend:

- CCP = Control/Compressor Access Panel
- BSP = Blower Service Panel
- *ASP = Additional Service Panel (not required)

Note:

*ASP are removable panels that provide additional access to the units interior. Clear access to ASP panels is not required and they are not to be used in place of the mandatory CCP and BSP panels.

HB - Horizontal Service Access

Left Return Back Discharge

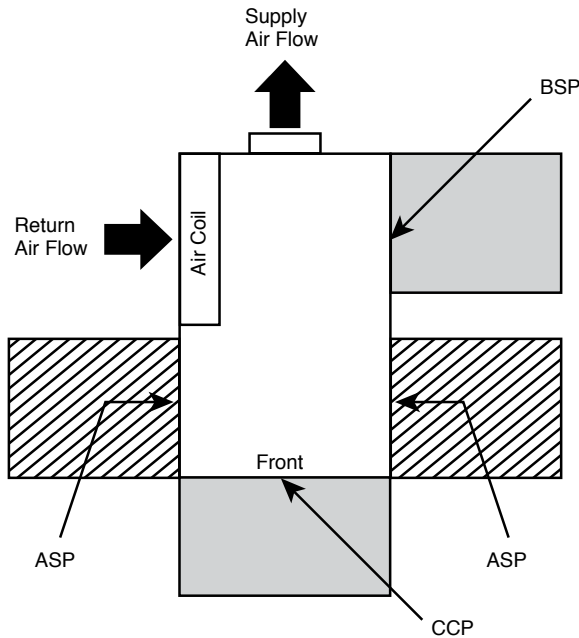

Right Return Back Discharge

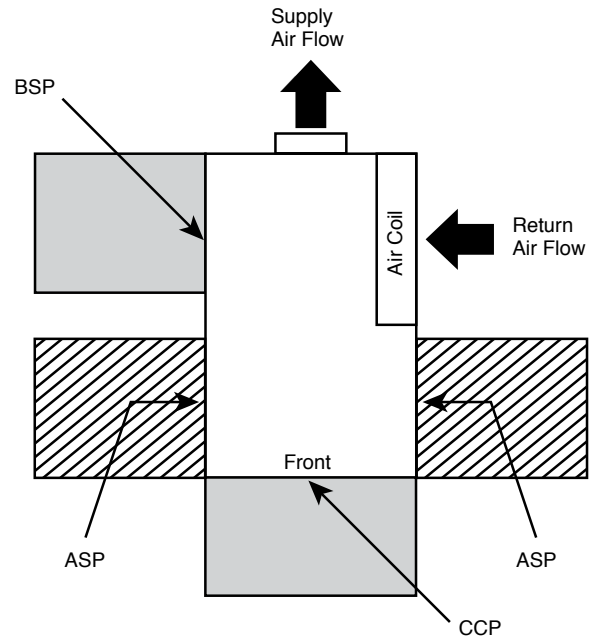

Left Return Straight Discharge

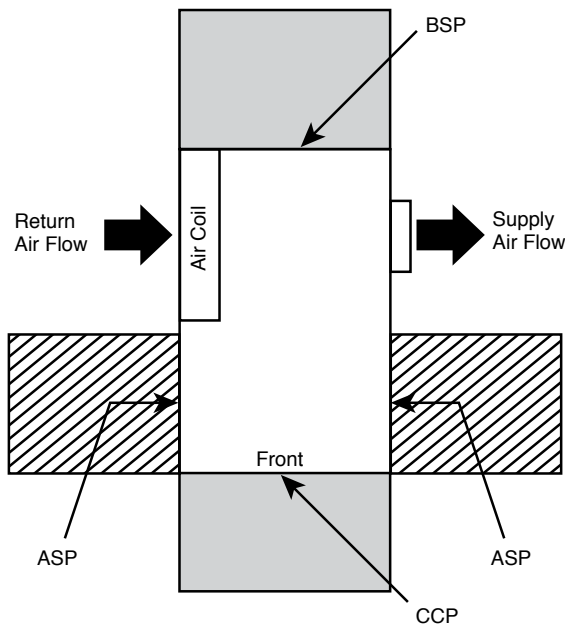

Right Return Straight Discharge

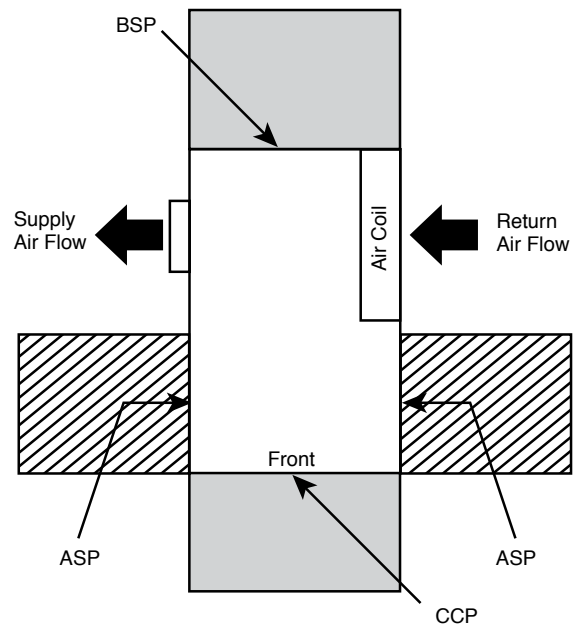

Notes:

1. While clear access to all removable panels is not required, installer should take care to comply with all building codes and allow adequate clearance for future field service.
2. CCP and BSP requires 2' service access.
3. Blower service access is through back panel on straight discharge units or through panel opposite air coil on back discharge units.
4. ASP are removable panels that provide additional access to the units interior. Clear access to ASP panels is not required and they are not to be used in place of the mandatory CCP and BSP panels.

= mandatory 2' service access

= (optional) additional 2' service access

Legend:

CCP = Control/Compressor Access Panel

BSP = Blower Service Panel

ASP = Additional Service Panel (not required)

HB - Vertical Upflow – Dimensional Data

Vertical Upflow Model		Overall Cabinet		
		A Width	B Depth	C Height
006 - 012	in cm	19.1 48.5	19.1 48.5	22.0 55.9
015 - 018	in cm	21.5 54.6	21.5 54.6	39.0 99.1
024 - 030, 041	in cm	21.5 54.6	21.5 54.6	40.0 101.6
036 - 042	in cm	21.5 54.6	26.0 66.0	45.0 114.3
048 - 060	in cm	24.0 61.0	32.5 82.6	46.0 116.8

Vertical Model		Electrical Knockouts		
		J 1/2"	K 1/2"	L 3/4"
		Low Voltage	Low Voltage	Power Supply
006 - 012	in cm	2.9 7.3	5.9 14.9	8.9 22.5
015 - 060	in cm	4.1 10.5	7.1 18.1	10.1 25.7
041	in cm	3.1 7.9	7.1 18.0	11.1 28.2

Vertical Upflow Model		Water Connections - Standard Units						
		①		②		③		Loop In/Out FPT
		Loop In D	Loop In E	Loop Out F	Loop Out G	Cond. 3/4" FPT		
						H	I	
006 - 012	in cm	1.4 3.6	1.6 4.1	9.5 24.1	1.6 4.3	6.1 15.6	1.6 4.1	1/2"
015	in cm	1.9 4.8	1.4 3.6	13.8 35.1	1.4 3.6	8.1 20.6	1.4 3.6	1/2"
018	in cm	1.9 4.8	1.4 3.6	12.9 32.8	1.4 3.6	8.1 20.6	1.4 3.6	1/2"
024	in cm	1.9 4.8	1.4 3.6	13.8 35.1	1.4 3.6	8.1 20.6	1.4 3.6	3/4"
030	in cm	1.9 4.8	1.4 3.6	15.2 38.6	1.4 3.6	8.1 20.6	1.4 3.6	3/4"
036	in cm	1.9 4.8	1.4 3.6	15.7 39.9	1.4 3.6	8.1 20.6	1.4 3.6	3/4"
041	in cm	3.6 4.8	2.3 5.8	14.0 35.6	2.3 5.8	8.1 20.6	2.3 5.8	3/4"
042	in cm	1.9 4.8	1.4 3.6	16.6 42.0	1.4 3.6	8.1 20.6	1.4 3.6	3/4"
048	in cm	1.9 4.8	1.4 3.6	16.6 42.2	1.4 3.6	8.1 20.6	1.4 3.6	1"
060	in cm	1.9 4.8	1.4 3.6	17.2 43.7	1.4 3.6	8.1 20.6	1.4 3.6	1"

Notes:

- While clear access to all removable panels is not required, installer should take care to comply with all building codes and allow adequate clearance for future field service.
- Front & Side access is preferred for service access. However, all components may be serviced from the front access panel if side access is not available. (Except on TCV 009-030 and 041 with front return) Units with the front return require left side access for the fan.
- Discharge flange is field installed.
- Condensate is 3/4" FPT.
- Units shipped with filter rails. These rails should be removed for return duct connection. See Aff---- for accessory air filter frame with

Recommended Minimum Installation Clearances for Vertical Units*	
1"	Back of unit
	Side opposite return air
6"	Front if hard piped
Return Air Side	
1"	Ducted return - ± Add for duct width - † Add 2" for 1" filter frame/rail or 3" for 2" filter frame/rail
	Free (open) return - calculate required dimension for a maximum velocity of 600 fpm

*Field installed accessories (hoses, air cleaners, etc.) may require additional space. Top supply air is shown, the same clearances apply to bottom supply air units.

duct collar.

Legend:

- CCP = Control/Compressor Access Panel
 BSP = Blower Service Panel
 ASP = Alternative Service Panel

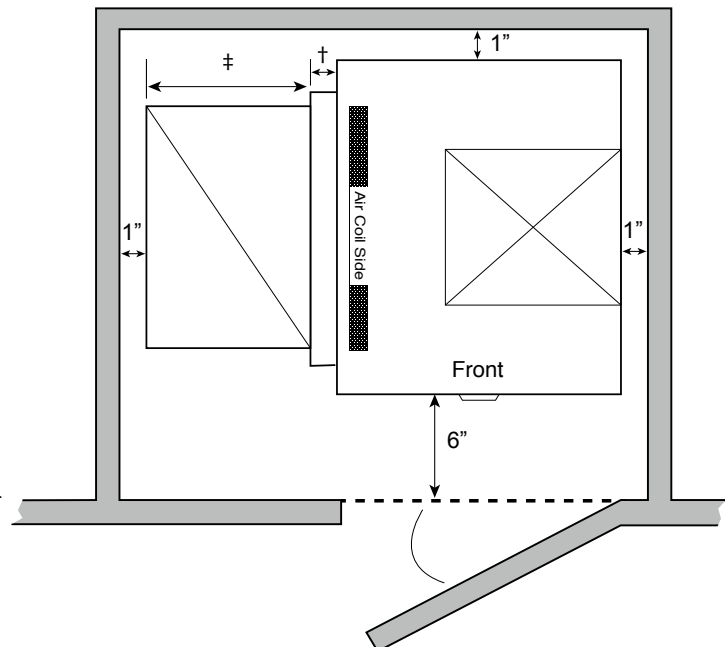

HB - Vertical Upflow – Dimensional Data

Vertical Model		Discharge Connection Duct Flange Installed (+/- 0.10 in, +/- 2.5mm)					Return Connection Using Return Air Opening			
		M	N	O Supply Width	P Supply Depth	Q	R	S Return Depth	T Return Height	U
006 - 012	in	8.9	5.1	9.0	9.0	5.5	2.1	16.2	9.9	0.7
	cm	22.7	12.9	22.9	22.9	14.0	5.3	41.1	25.1	1.9
015 - 018	in	6.4	3.8	14.0	14.0	5.3	2.3	18.3	20.9	0.7
	cm	16.1	9.5	35.6	35.6	13.6	5.8	46.5	53.1	1.9
024 - 030, *041	in	6.4	5.0	14.0	14.0	5.8	2.0	18.5	19.3	0.9
	cm	16.3	12.7	35.6	35.6	14.7	5.1	47.0	49.0	2.3
036 - 042	in	6.4	3.8	14.0	14.0	5.1	2.3	22.8	23.9	0.7
	cm	16.1	9.5	35.6	35.6	13.1	5.8	57.9	60.7	1.9
048 - 060	in	6.9	7.3	16.0	18.0	5.1	2.3	29.3	22.5	0.7
	cm	17.4	18.4	40.6	45.7	13.1	5.8	74.4	57.0	1.9

*Size 041 units have unique M, N, Q dimensions due to the position of the blower assembly.
 Front Return - N = 4.8 in (12.2 cm), Q = 6.4 in (16.3 cm).
 Right Return - N = 3.8 in (9.7 cm), Q = 5.5 in (14.0 cm).
 Left Return - M = 6.4 in (16.3 cm), N = 2.8 in (7.1 cm).

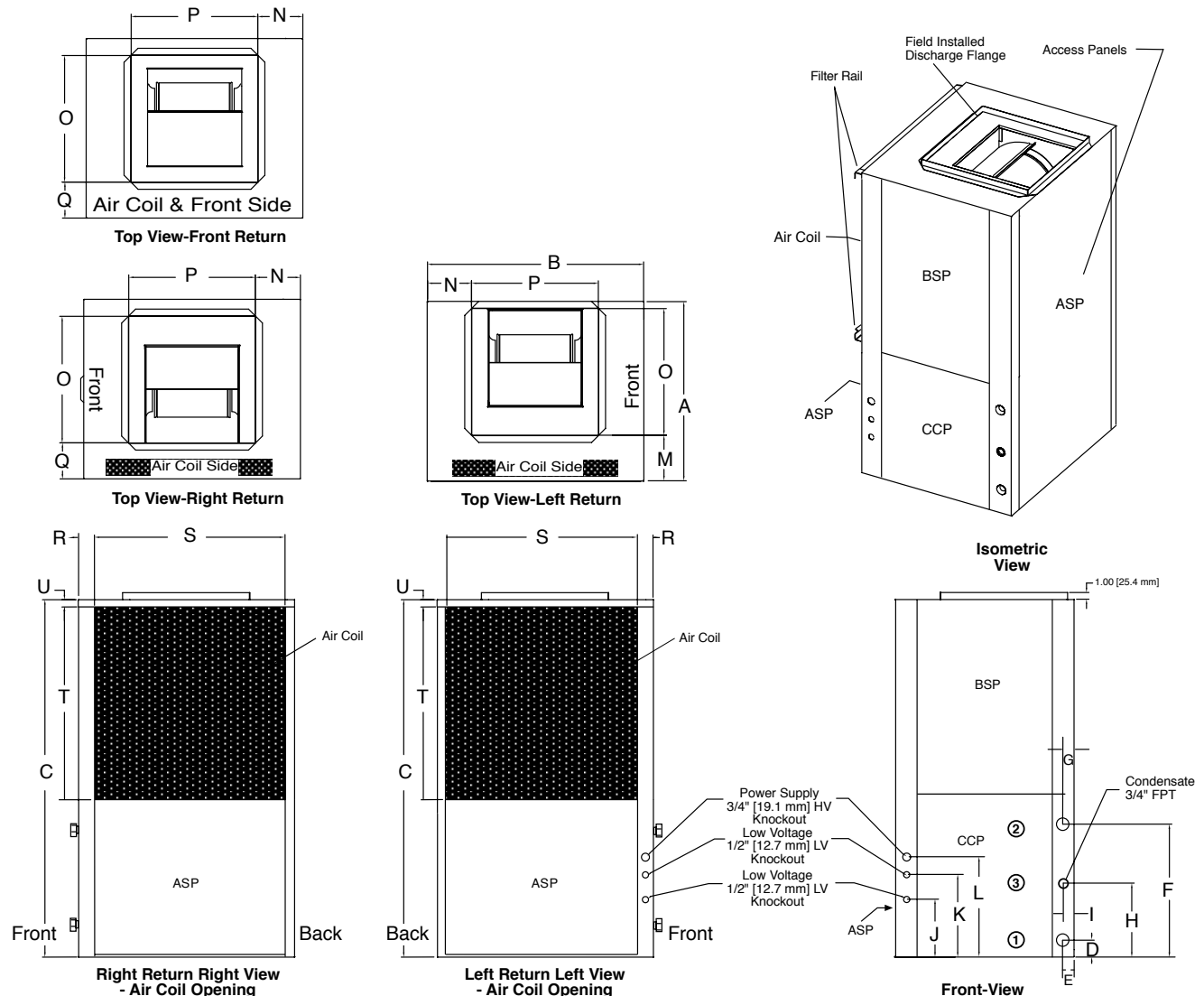

Units shipped with filter rails. These rails should be removed for return duct connection.
 See Aff--- for accessory air filter frame with duct collar.

HB - Vertical Service Access

Vertical Units

Left Return

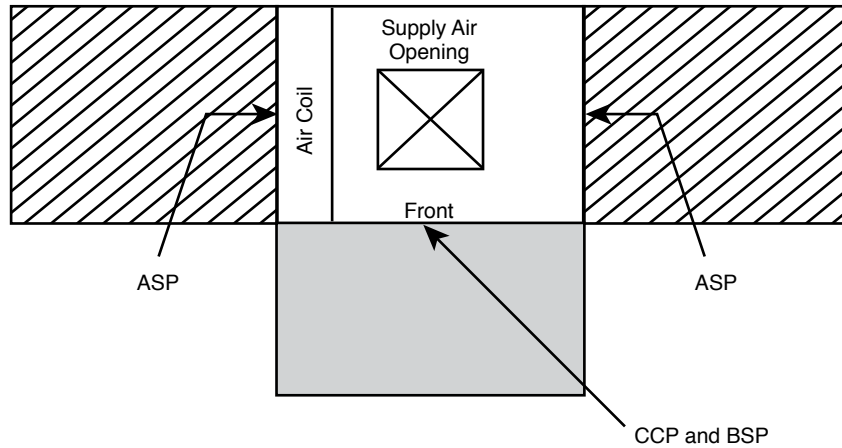

Right Return

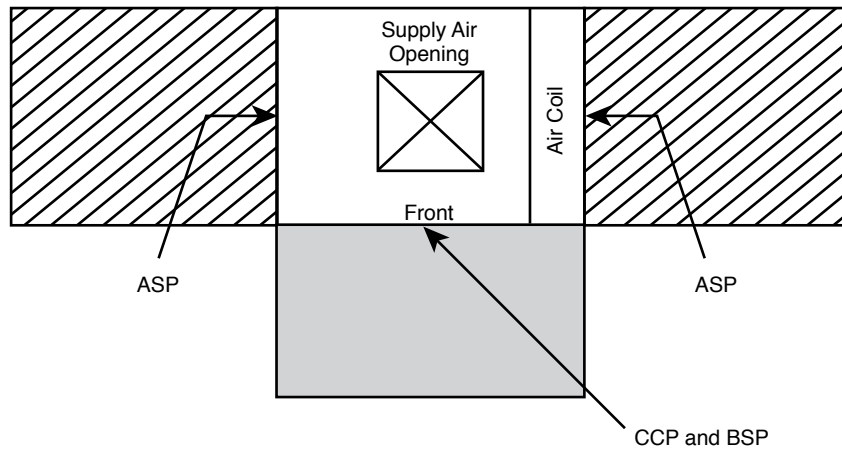

Notes:

1. While clear access to all removable panels is not required, installer should take care to comply with all building codes and allow adequate clearance for future field service.
2. Front & Side access is preferred for service access. However, all components may be serviced from the front access panel if side access is not available.
3. ASP are removable panels that provide additional access to the units interior. Clear access to ASP panels is not required and they are not to be used in place of the mandatory CCP and BSP panels.
4. Top supply air is shown, the same clearances apply to bottom supply air units.
5. Front return units (not shown) require front access for controls/compressor and left side access for blower.

- = mandatory 2' service access
- = (optional) additional 2' service access

Legend:

- CCP = Control/Compressor Access Panel
- BSP = Blower Service Panel
- ASP = Additional Service Panel (not required)

Corner Weights for HBH Series Units

Model		Total	Left-Front*	Right-Front*	Left-Back*	Right-Back*
HBH006	Lbs	103	37	24	23	19
	kg	46.72	16.78	10.89	10.43	8.62
HBH009	Lbs	105	38	24	23	20
	kg	47.63	17.24	10.89	10.43	9.07
HBH012	Lbs	114	42	26	25	21
	kg	51.71	19.05	11.79	11.34	9.53
HBH015	Lbs	153	53	36	34	30
	kg	69	24	16	15	14
HBH018	Lbs	158	55	37	35	31
	kg	72	25	17	16	14
HBH024	Lbs	174	62	40	39	33
	kg	79	28	18	18	15
HBH030	Lbs	182	67	41	40	34
	kg	83	30	19	18	15
HBH036	Lbs	203	75	47	44	37
	kg	92	34	21	20	17
HBH042	Lbs	218	81	50	48	39
	kg	99	37	23	22	18
HBH048	Lbs.	263	98	60	58	47
	kg	119	44	27	26	21
HBH060	Lbs.	278	94	59	56	69
	kg	126	43	27	25	31

*Front is control box end.

Electrical Data – Standard Unit

Model	Voltage Code	Rated Voltage	Voltage Min/Max	Compressor			Fan Motor FLA	Total Unit FLA	Min Circuit Amp	Max Fuse/HACR
				QTY	RLA	LRA				
006	G	208/230/60/1	197/254	1	3.3	17.7	0.40	3.7	4.5	15
	E	265/60/1	239/292	1	2.9	13.5	0.40	3.3	4.0	15
009	G	208/230/60/1	197/254	1	4.5	22.2	0.92	5.4	6.5	15
	E	265/60/1	239/292	1	3.8	18.8	0.70	4.5	5.5	15
012	G	208/230/60/1	197/254	1	5.1	32.5	0.92	6.0	7.3	15
	E	265/60/1	239/292	1	4.0	31.5	0.70	4.7	5.7	15
015	G	208/230/60/1	197/254	1	6.0	29.0	1.20	7.2	8.7	15
	E	265/60/1	239/292	1	5.4	28.0	0.86	6.8	8.2	15
018	G	208/230/60/1	197/254	1	7.2	33.0	1.20	8.4	10.2	15
	E	265/60/1	239/292	1	5.9	28.0	0.86	6.8	8.2	15
024	G	208/230/60/1	197/254	1	12.8	58.3	1.50	14.3	17.5	30
	E	265/60/1	239/292	1	9.6	54.0	1.30	10.9	13.3	20
	H	208/230/60/3	197/254	1	7.7	55.4	1.50	9.2	11.1	15
	F	460/60/3	414/506	1	3.6	28.0	0.76	4.4	5.3	15
030	G	208/230/60/1	197/254	1	14.1	73.0	3.00	17.1	20.6	30
	E	265/60/1	239/292	1	11.2	60.0	2.70	13.9	16.7	25
	H	208/230/60/3	197/254	1	8.9	58.0	3.00	11.9	14.1	20
	F	460/60/3	414/506	1	4.2	28.0	1.70	5.9	7.0	15
036	G	208/230/60/1	197/254	1	16.7	79.0	1.80	18.5	22.7	35
	E	265/60/1	239/292	1	13.5	72.0	2.00	15.5	18.9	30
	H	208/230/60/3	197/254	1	10.4	73.0	1.80	12.2	14.8	25
	F	460/60/3	414/506	1	5.8	38.0	1.24	7.0	8.5	15
041	G	208/230/60/1	197/254	1	17.9	112.0	3.00	20.9	25.4	40
	H	208/230/60/3	197/254	1	13.2	88.0	3.00	16.2	19.5	30
	F	460/60/3	414/506	1	6.0	44.0	1.70	7.7	9.2	15
	N	575/60/3	518/633	1	4.2	30.0	1.40	5.6	6.7	15
042	G	208/230/60/1	197/254	1	17.9	112.0	3.00	20.9	25.4	40
	H	208/230/60/3	197/254	1	13.5	88.0	3.00	16.5	19.9	30
	F	460/60/3	414/506	1	6.0	44.0	1.70	7.7	9.2	15
	N	575/60/3	518/633	1	4.9	34.0	1.40	6.3	7.5	15
048	G	208/230/60/1	197/254	1	21.8	117.0	3.40	25.2	30.7	50
	H	208/230/60/3	197/254	1	13.7	83.1	3.40	17.1	20.5	30
	F	460/60/3	414/506	1	6.2	41.0	1.80	8.0	9.6	15
	N	575/60/3	518/633	1	4.8	33.0	1.40	6.2	7.4	15
060	G	208/230/60/1	197/254	1	26.3	134.0	4.90	31.2	37.8	60
	H	208/230/60/3	197/254	1	15.6	110.0	4.90	20.5	24.4	40
	F	460/60/3	414/506	1	7.8	52.0	2.50	10.3	12.3	20
	N	575/60/3	518/633	1	5.8	38.9	1.90	7.7	9.2	15

All fuses Class RK-5

Electrical Data – High Static Blower

HB Model	Voltage Code	Rated Voltage	Voltage Min/Max	Compressor			Fan Motor FLA	Total Unit FLA	Min Circuit Amp	Max Fuse/HACR
				QTY	RLA	LRA				
015	G	208/230/60/1	197/254	1	6.0	29.0	1.20	7.2	8.7	15
	E	265/60/1	239/292	1	5.4	28.0	0.86	6.3	7.6	15
018	G	208/230/60/1	197/254	1	7.2	33.0	1.50	8.7	10.5	15
	E	265/60/1	239/292	1	5.9	28.0	1.30	7.2	8.7	15
024	G	208/230/60/1	197/254	1	12.8	58.3	1.50	14.3	17.5	30
	E	265/60/1	239/292	1	9.6	54.0	1.30	10.9	13.3	20
	H	208/230/60/3	197/254	1	7.7	55.4	1.50	9.2	11.1	15
	F	460/60/3	414/506	1	3.6	28.0	0.76	4.4	5.3	15
030	G	208/230/60/1	197/254	1	14.1	73.0	3.00	17.1	20.6	30
	E	265/60/1	239/292	1	11.2	60.0	2.70	13.9	16.7	25
	H	208/230/60/3	197/254	1	8.9	58.0	3.00	11.9	14.1	20
	F	460/60/3	414/506	1	4.2	28.0	1.70	5.9	7.0	15
036	G	208/230/60/1	197/254	1	16.7	79.0	3.00	19.7	23.9	40
	E	265/60/1	239/292	1	13.5	72.0	2.70	16.2	19.6	30
	H	208/230/60/3	197/254	1	10.4	73.0	3.00	13.4	16.0	25
	F	460/60/3	414/506	1	5.8	38.0	1.70	7.5	9.0	15
042	G	208/230/60/1	197/254	1	17.9	112.0	3.00	20.9	25.4	40
	H	208/230/60/3	197/254	1	13.5	88.0	3.00	16.5	19.9	30
	F	460/60/3	414/506	1	6.0	44.0	1.70	7.7	9.2	15
	N	575/60/3	518/633	1	4.9	34.0	1.40	6.3	7.5	15
048	G	208/230/60/1	197/254	1	21.8	117.0	4.90	26.7	32.2	50
	H	208/230/60/3	197/254	1	13.7	83.1	4.90	18.6	22.0	35
	F	460/60/3	414/506	1	6.2	41.0	2.50	8.7	10.3	15
	N	575/60/3	518/633	1	4.8	33.0	1.90	6.7	7.9	15
060	G	208/230/60/1	197/254	1	26.3	134.0	5.80	32.1	38.7	60
	H	208/230/60/3	197/254	1	15.6	110.0	5.80	21.4	25.3	40
	F	460/60/3	414/506	1	7.8	52.0	2.60	10.4	12.4	20
	N	575/60/3	518/633	1	5.8	38.9	2.30	8.1	9.6	15

All fuses Class RK-5

Electrical Data – ECM

HB Model	Voltage Code	Rated Voltage	Voltage Min/Max	Compressor			Fan Motor FLA	Total Unit FLA	Min Circuit Amp	Max Fuse/HACR
				RLA	LRA	QTY				
015	G	208/230/60/1	197/254	6.0	29.0	1	2.70	8.7	10.2	15
	E	265/60/1	239/292	5.4	28.0	1	2.10	7.5	8.9	15
018	G	208/230/60/1	197/254	7.2	33.0	1	2.70	9.9	11.7	15
	E	265/60/1	239/292	5.9	28.0	1	2.10	8.0	9.5	15
024	G	208/230/60/1	197/254	12.8	58.3	1	3.90	16.7	19.9	30
	E	265/60/1	239/292	9.6	54.0	1	3.20	12.8	15.2	20
	H	208/230/60/3	197/254	7.7	55.4	1	3.90	11.6	13.5	20
	*F	*460/60/3	414/506	3.6	28.0	1	3.20	6.8	7.7	15
030	G	208/230/60/1	197/254	14.1	73.0	1	3.90	18.0	21.5	35
	E	265/60/1	239/292	11.2	60.0	1	3.20	14.4	17.2	25
	H	208/230/60/3	197/254	8.9	58.0	1	3.90	12.8	15.0	20
	*F	*460/60/3	414/506	4.2	28.0	1	3.20	7.4	8.5	15
036	G	208/230/60/1	197/254	16.7	79.0	1	5.20	21.9	26.1	40
	E	265/60/1	239/292	13.5	72.0	1	4.70	18.2	21.6	35
	H	208/230/60/3	197/254	10.4	73.0	1	5.20	15.6	18.2	25
	*F	*460/60/3	414/506	5.8	38.0	1	4.70	10.5	12.0	15
042	G	208/230/60/1	197/254	17.9	112.0	1	5.20	23.1	27.6	45
	H	208/230/60/3	197/254	13.5	88.0	1	5.20	18.7	22.1	35
	*F	*460/60/3	414/506	6.0	44.0	1	4.70	10.7	12.2	15
048	G	208/230/60/1	197/254	21.8	117.0	1	6.90	28.7	34.2	50
	H	208/230/60/3	197/254	13.7	83.1	1	6.90	20.6	24.0	35
	*F	*460/60/3	414/506	6.2	41.0	1	6.00	12.2	13.8	20
060	G	208/230/60/1	197/254	26.3	134.0	1	6.90	33.2	39.8	60
	H	208/230/60/3	197/254	15.6	110.0	1	6.90	22.5	26.4	40
	*F	*460/60/3	414/506	7.8	52.0	1	6.00	13.8	15.8	20

* 460 volt units require a neutral connection. All "F" voltage units with ECM require a four wire power supply with neutral. Motors are 265 volt and are wired between one hot leg and neutral.

All fuses Class RK-5

HB Series Wiring Diagram Matrix

Only CXM and DXM diagrams, with a representative diagram of LON and MPC Options are presented in this submittal. Other diagrams can be located online at MARS.com using the part numbers presented below.

Model	Wiring Diagram Part Number	Electrical	Control	DDC	Fan Motor
HB Series Single Phase	96B0228N77	208/230/60/1 265/60/1	CXM	-	ECM
	96B0228N81			LON	
	96B0228N79			MPC	
	96B0006N01			-	PSC
	96B0006N03			LON	
	96B0006N09			MPC	
	96B0228N78		DXM	-	ECM
	96B0228N82			LON	
	96B0228N80			MPC	
	96B0006N02			-	PSC
	96B0006N04			LON	
	96B0006N10			MPC	
HB Series Three Phase (230 Style)	96B0229N11	208/230/60/3	CXM	-	ECM
	96B0229N13			LON	
	96B0229N16			MPC	
	96B0007N01			-	PSC
	96B0007N03			LON	
	96B0007N06			MPC	
	96B0229N12		DXM	-	ECM
	96B0229N14			LON	
	96B0229N17			MPC	
	96B0007N02			-	PSC
	96B0007N04			LON	
	96B0007N07			MPC	
HB Series Three Phase (460 Style)	96B0230N11	460/60/3	CXM	-	ECM
	96B0230N13			LON	
	96B0230N18			MPC	
	96B0008N01			-	PSC
	96B0008N03			LON	
	96B0008N08			MPC	
	96B0230N12		DXM	-	ECM
	96B0230N14			LON	
	96B0230N19			MPC	
	96B0008N02			-	PSC
	96B0008N04			LON	
	96B0008N09			MPC	

All wiring diagrams available at climatemaster.com.

Typical Wiring Diagram – Single Phase HB Units with CXM Controller, ECM Blower

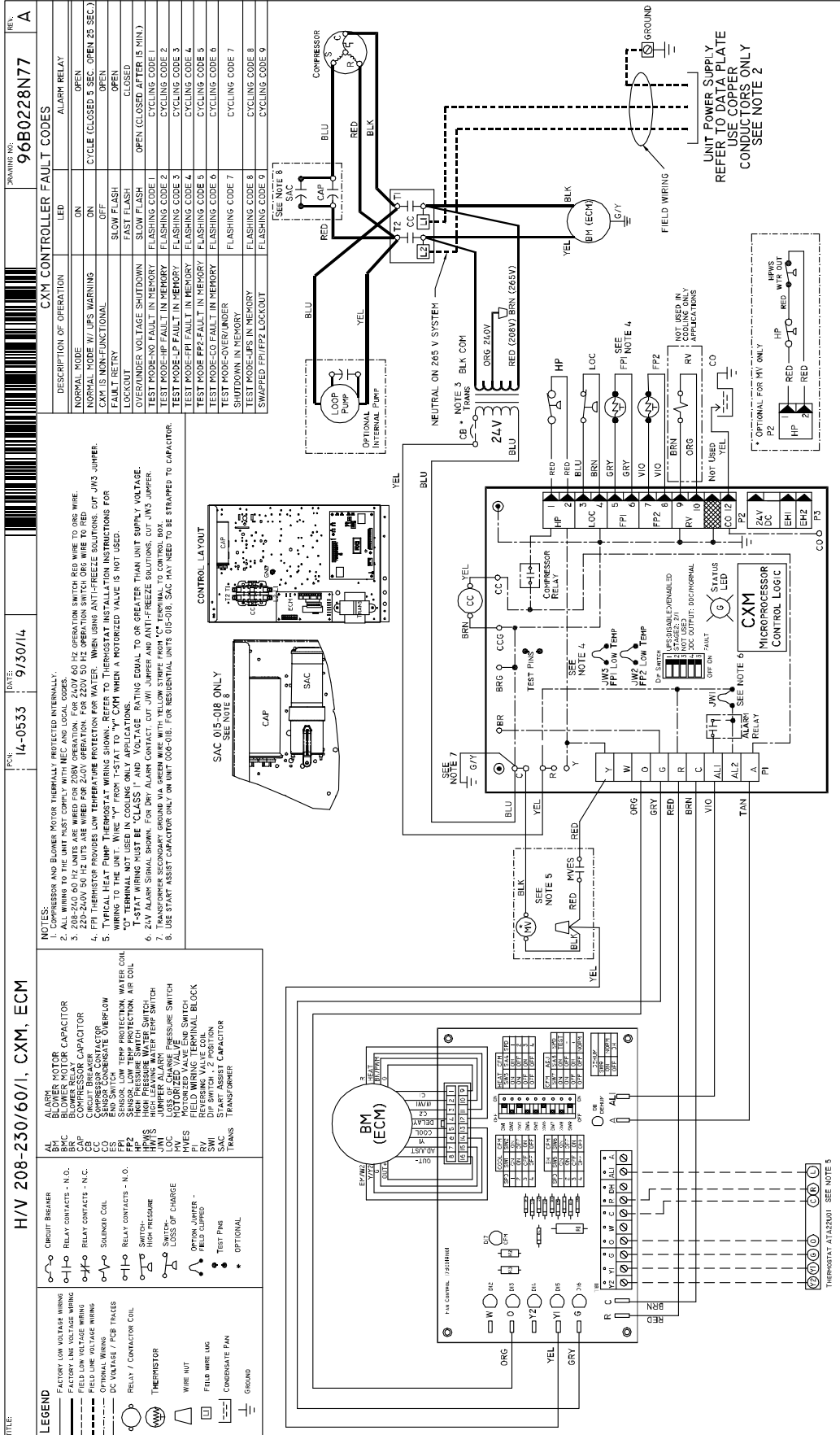

Typical Wiring Diagram – Three Phase 460/575V HB Units with CXM And LON Controller

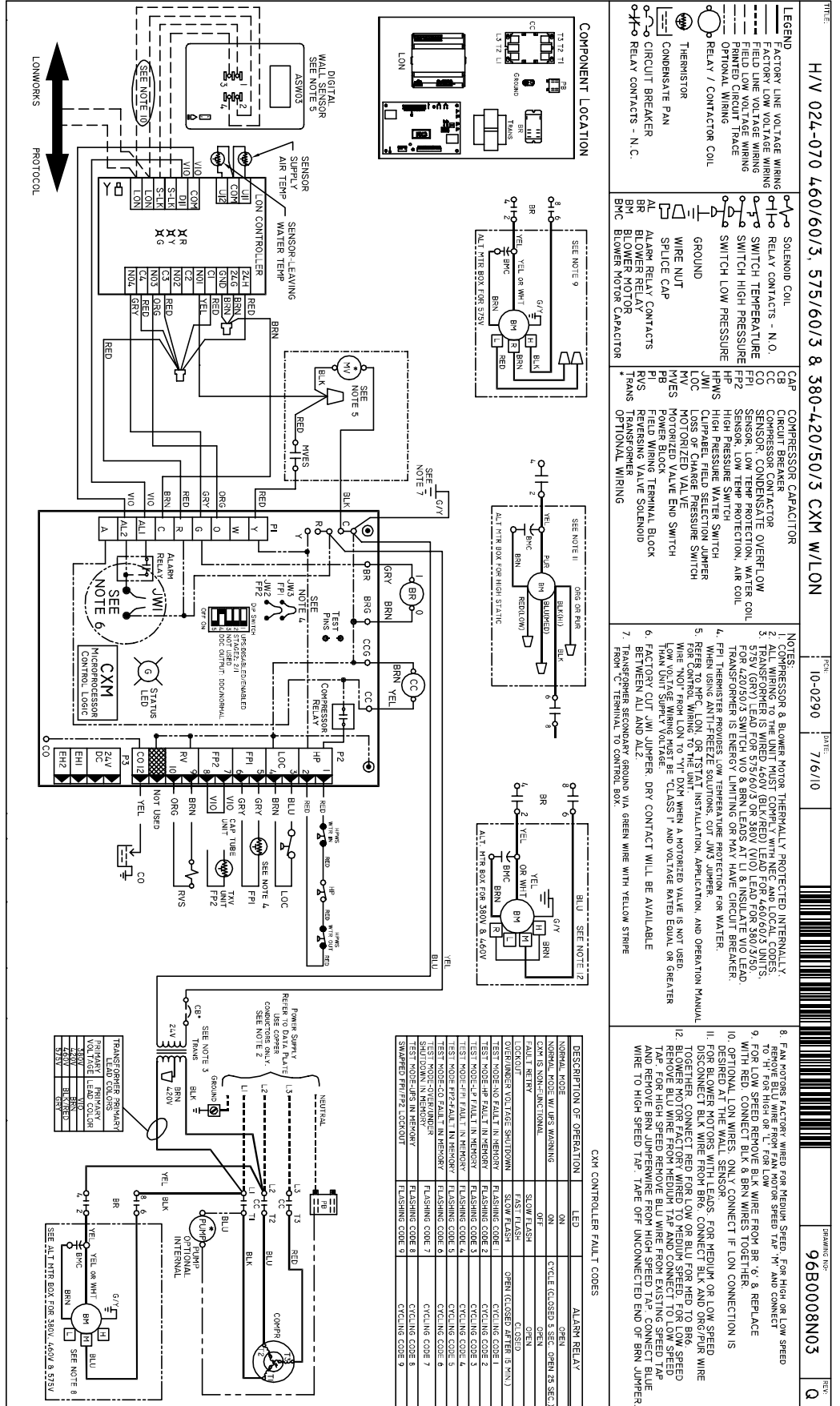

Typical Wiring Diagram - Three Phase 460/575V HB Units with DXM & MPC Controller

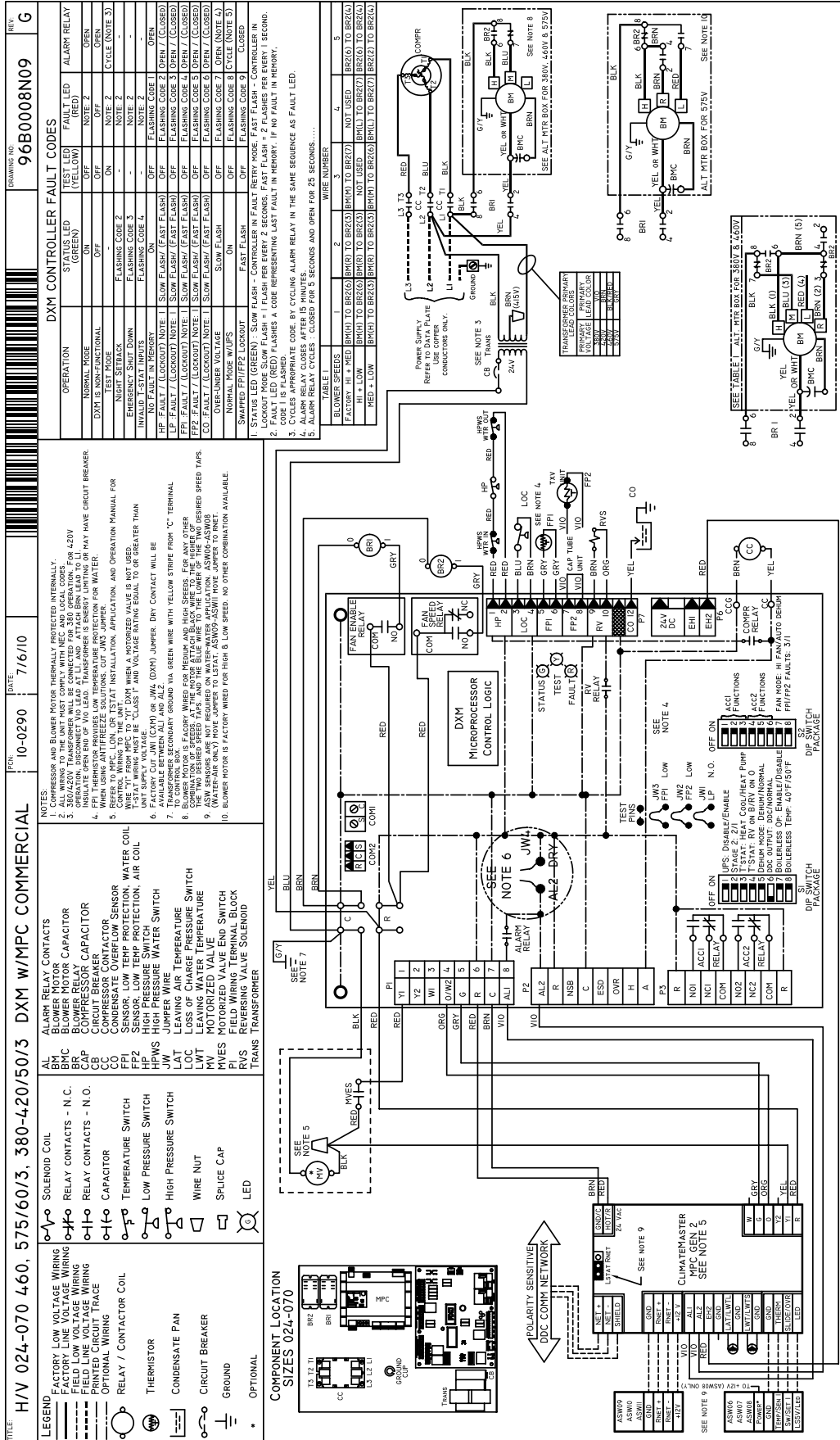

(HB) Series 60Hz Engineering Specifications – Page 1

General:

Furnish and install MARS “HB” Water Source Heat Pumps, as indicated on the plans. Equipment shall be completely assembled, piped and internally wired. Capacities and characteristics as listed in the schedule and the specifications that follow.

Units shall be supplied completely factory built capable of operating over an entering water temperature range from 20° to 120°F (-6.7° to 48.9°C) as standard. Equivalent units from other manufacturers may be proposed provided approval to bid is given 10 days prior to bid closing. All equipment listed in this section must be rated and certified in accordance with Air-Conditioning, Heating and Refrigeration Institute/International Standards Organization (AHRI/ISO 13256-1). All equipment must be tested, investigated, and determined to comply with the requirements of the standards for Heating and Cooling Equipment UL-1995 for the United States and CAN/CSA-C22.2 NO.236 for Canada, by Intertek Testing Laboratories (ETL). The units shall have AHRI/ISO and ETL-US-C labels.

All units shall be fully quality tested by factory run testing under normal operating conditions as described herein. Quality control system shall automatically perform via computer: triple leak check, pressure tests, evacuation and accurately charge system, perform detailed heating and cooling mode tests, and quality cross check all operational and test conditions to pass/fail criteria. Detailed report card will ship with each unit displaying status for critical tests and components. **Note: If unit fails on any cross check, it shall not be allowed to ship. Serial numbers will be recorded by factory and furnished to contractor on report card for ease of unit warranty status. Units tested without water flow are not acceptable.**

Basic Construction:

Horizontal units shall have one of the following air flow arrangements: Left Inlet/Straight (Right) Discharge; Right Inlet/Straight (Left) Discharge; Left Inlet/Back Discharge; or Right Inlet/Back Discharge as shown on the plans. Units must have the ability to be field convertible from straight to back or back to straight discharge with no additional parts or unit structure modification. Horizontal units will have factory installed hanger brackets with rubber isolation grommets packaged separately.

Vertical units shall have one of the following airflow arrangements: Left Return/Top Discharge, Right Return/Top Discharge, as shown on the plans.

If units with these arrangements are not used, the contractor is responsible for any extra costs incurred by other trades. All units (horizontal and vertical) must have a minimum of two access panels for serviceability of compressor compartment. **Units having only one access panel to compressor/heat exchangers/expansion device/refrigerant piping shall not be acceptable.**

All interior surfaces shall be lined with 1/2 inch (12.7mm) thick, 1-1/2 lb/ft³ (24 kg/m³) acoustic type glass fiber insulation. Insulation placement shall be designed in a manner that will eliminate any exposed edges to prevent the introduction of glass fibers into the air stream.

The heat pumps shall be fabricated from heavy gauge galvanized steel with powder coat paint finish on the front access panels.

Standard cabinet panel insulation must meet NFPA 90A requirements, air erosion and mold growth limits of UL-181, stringent fungal resistance test per ASTM-C1071 and ASTM G21, and shall meet zero level bacteria growth per ASTM G22. **Unit insulation must meet these stringent requirements or unit(s) will not be accepted.**

All horizontal units to have factory installed 1” (25.4mm) discharge air duct collars, 1” (25.4mm) filter rails with 1” (25.4mm) filters factory installed, and factory installed unit-mounting brackets. Vertical units to have field installed discharge air duct collar, shipped loose and 1” (25.4mm) filter rails with 1” (25.4mm) filters factory installed. **If units with these factory installed provisions are not used, the contractor is responsible for any extra costs to field install these provisions, and/or the extra costs for his sub-contractor to install these provisions.**

All units must have an insulated panel separating the fan compartment from the compressor compartment. Units with the compressor in the air stream are not acceptable. Units shall have factory installed 1 inch (25.4mm) wide filter rails for filter removal from either side. Units shall have a 1 inch (25.4mm) thick throwaway type glass fiber filter. The contractor shall purchase one spare set of filters and replace factory shipped filters on completion of start-up. Filters shall be standard sizes. If units utilize non-standard filter sizes then the contractor shall provide 12 spare filters for each unit.

(HB) Series 60Hz Engineering Specifications – Page 2

Cabinets shall have separate holes and knockouts for entrance of line voltage and low voltage control wiring. All factory-installed wiring passing through factory knockouts and openings shall be protected from sheet metal edges at openings by plastic ferrules. Supply and return water connections shall be copper FPT fittings. All water connections and electrical knockouts must be in the compressor compartment corner post as to not interfere with the serviceability of unit. Contractor shall be responsible for any extra costs involved in the installation of units that do not have this feature. Contractor must ensure that units can be easily removed for servicing and coordinate locations of electrical conduit and lights with the electrical contractor.

Option: Contractor shall install 2-inch (50.8mm) filter frame with removable access door and 2 inch (50.8mm) Glass Fiber throwaway filters on all units.

Option: UltraQuiet package shall consist of spring isolation under compressor; discharge muffler (except rotary compressors); and sound attenuating material applied to the fan housing.

Option: The unit shall be supplied with extended range insulation option, which adds closed cell insulation to internal water lines, and provides insulation on suction side refrigeration tubing including refrigerant to water heat exchanger.

Fan and Motor Assembly:

Blower shall have inlet rings to allow removal of wheel and motor from one side without removing housing. Units shall have a direct-drive centrifugal fan. The fan motor shall be 3-speed (2-speed for 575V), permanently lubricated, PSC type, with internal thermal overload protection. Units supplied without permanently lubricated motors must provide external oilers for easy service. The fan motor on small and medium size units (006-042) shall be isolated from the fan housing by a torsionally flexible motor mounting system with rubber type grommets to inhibit vibration induced high noise levels associated with “hard wire belly band” motor mounting. The fan motor on larger units (048 & 060) shall be isolated with flexible rubber type isolation grommets only. The fan and motor assembly must be capable of overcoming the external static pressures as shown on the schedule. Airflow/Static pressure rating of the unit shall be based on a wet coil and a clean filter in place.

Option: High static motors (Sizes 015-060)

Option: ECM blower motors (Sizes 015-060)

Refrigerant Circuit:

All units shall contain an EarthPure® (HFC-410A) sealed refrigerant circuit including a high efficiency scroll or rotary compressor designed for heat pump operation, a thermostatic expansion valve for refrigerant metering, an enhanced corrugated aluminum lanced fin and rifled copper tube refrigerant to air heat exchanger, reversing valve, coaxial (tube in tube) refrigerant to water heat exchanger, and safety controls including a high pressure switch, low pressure (loss of charge) switch, water coil low temperature sensor, and air coil low temperature sensor. Access fittings shall be factory installed on high and low pressure refrigerant lines to facilitate field service. Activation of any safety device shall prevent compressor operation via a microprocessor lockout circuit. The lockout circuit shall be reset at the thermostat or at the contractor supplied disconnect switch. **Units that cannot be reset at the thermostat shall not be acceptable.**

Hermetic compressors shall be internally sprung. The compressor shall have a dual level vibration isolation system. The compressor will be mounted on specially engineered sound-tested EPDM vibration isolation grommets or springs to a large heavy gauge compressor mounting plate, which is then isolated from the cabinet base with rubber grommets for maximized vibration attenuation. Compressor shall have thermal overload protection. Compressor shall be located in an insulated compartment away from air stream to minimize sound transmission.

Refrigerant to air heat exchangers shall utilize enhanced corrugated lanced aluminum fins and rifled copper tube construction rated to withstand 625 PSIG (4309 kPa) refrigerant working pressure. Refrigerant to water heat exchangers shall be of copper inner water tube and steel refrigerant outer tube design, rated to withstand 625 PSIG (4309 kPa) working refrigerant pressure and 500 PSIG (3445 kPa) working water pressure. The refrigerant to water heat exchanger shall be “electro-coated” with a low cure cathodic epoxy material a minimum of 0.4 mils thick (0.4 – 1.5 mils range) on all surfaces. The black colored coating shall provide a minimum of 1000 hours salt spray protection per ASTM B117-97 on all external steel and copper tubing. The material shall be formulated without the inclusion of any heavy metals and shall exhibit a pencil hardness of 2H (ASTM D3363-92A), crosshatch adhesion of 4B-5B (ASTM D3359-95), and impact resistance of 160 in-lbs (184 kg-cm) direct (ASTM D2794-93).

Refrigerant metering shall be accomplished by thermostatic expansion valve only. Expansion valves shall be dual port balanced type with external equalizer for optimum refrigerant metering. Units shall be designed and tested for operating ranges of entering water temperatures from 20° to 120°F (-6.7° to 48.9°C). Reversing valve shall be four-way solenoid activated refrigerant valve, which shall default to heating mode should the solenoid fail to function. If the reversing valve solenoid defaults to cooling mode, an additional low temperature thermostat must be provided to prevent over-cooling an already cold room.

(HB) Series 60Hz Engineering Specifications – Page 3

Option: The unit will be supplied with cupro-nickel coaxial water to refrigerant heat exchanger.

Drain Pan:

The drain pan shall be constructed of galvanized steel and have a powder coat paint application to further inhibit corrosion. This corrosion protection system shall meet the stringent 1000 hour salt spray test per ASTM B117. If plastic type material is used, it must be HDPE (High Density Polyethylene) to avoid thermal cycling shock stress failure over the lifetime of the unit. Drain pan shall be fully insulated. Drain outlet shall be located at pan as to allow unobstructed drainage of condensate. Drain outlet for horizontal units shall be connected from pan directly to FPT fitting. **No hidden internal tubing extensions from pan outlet extending to unit casing (that can create drainage problems) will be accepted.** The unit as standard will be supplied with solid-state electronic condensate overflow protection. **Mechanical float switches will NOT be accepted.**

Vertical units shall be furnished with a PVC FPT condensate drain connection and an internal factory installed condensate trap. **If units without an internal trap are used, the contractor is responsible for any extra costs to field install these provisions, and/or the extra costs for his sub-contractor to install these provisions.**

Option: The unit shall be supplied with stainless steel drain pan.

Electrical:

A control box shall be located within the unit compressor compartment and shall contain a 50VA transformer, 24 volt activated, 2 or 3 pole compressor contactor, terminal block for thermostat wiring and solid-state controller for complete unit operation. Reversing valve and fan motor wiring shall be routed through this electronic controller. Units shall be name-plated for use with time delay fuses or HACR circuit breakers. Unit controls shall be 24 Volt and provide heating or cooling as required by the remote thermostat/sensor.

Solid State Control System (CXM):

Units shall have a solid-state control system. **Units utilizing electro-mechanical control shall not be acceptable.** The control system microprocessor board shall be specifically designed to protect against building electrical system noise contamination, EMI, and RFI interference. The control system shall interface with a heat pump type thermostat. The control system shall have the following features:

- a. Anti-short cycle time delay on compressor operation.
- b. Random start on power up mode.
- c. Low voltage protection.
- d. High voltage protection.
- e. Unit shutdown on high or low refrigerant pressures.
- f. Unit shutdown on low water temperature.
- g. Condensate overflow electronic protection.
- h. Option to reset unit at thermostat or disconnect.
- i. Automatic intelligent reset. Unit shall automatically reset the unit 5 minutes after trip if the fault has cleared. If a fault occurs 3 times sequentially without thermostat meeting temperature, then lockout requiring manual reset will occur.
- j. Ability to defeat time delays for servicing.
- k. Light emitting diode (LED) on circuit board to indicate high pressure, low pressure, low voltage, high voltage, low water/air temperature cut-out, condensate overflow, and control voltage status.
- l. The low-pressure switch shall not be monitored for the first 120 seconds after a compressor start command to prevent nuisance safety trips.
- m. 24V output to cycle a motorized water valve or other device with compressor contactor.
- n. Unit Performance Sentinel (UPS). The UPS warns when the heat pump is running inefficiently.
- o. Water coil low temperature sensing (selectable for water or anti-freeze).
- p. Air coil low temperature sensing.

NOTE: Units not providing the 8 safety protections of anti-short cycle, low voltage, high voltage, high refrigerant pressure, low pressure (loss of charge), air coil low temperature cut-out, water coil low temperature cut-out, and condensate overflow protections will not be accepted.

Option: Enhanced solid state control system (DXM):

This control system features two stage control of cooling and two stage control of heating modes for exacting temperature and dehumidification purposes.

(HB) Series 60Hz Engineering Specifications – Page 4

This control system coupled with a multi-stage thermostat will better dehumidify room air by automatically running the heat pump's fan at lower speed on the first stage of cooling thereby implementing low sensible heat ratio cooling. On the need for higher cooling performance the system will activate the second stage of cooling and automatically switch the fan to the higher fan speed setting. This system may be further enhanced with a humidistat. **Units not having automatic low sensible heat ratio cooling will not be accepted; as an alternate a hot gas reheat coil may be provided with control system for automatic activation.**

Control shall have all of the above mentioned features of the CXM control system along with the following expanded features:

- a. Removable thermostat connector.
- b. Night setback control.
- c. Random start on return from night setback.
- d. Minimized reversing valve operation (Unit control logic shall only switch the reversing valve when cooling is demanded for the first time. The reversing valve shall be held in this position until the first call for heating, ensuring quiet operation and increased valve life.).
- e. Override temperature control with 2-hour timer for room occupant to override setback temperature at the thermostat.
- f. Dry contact night setback output for digital night setback thermostats.
- g. Ability to work with heat pump or heat/cool (Y, W) type thermostats.
- h. Ability to work with heat pump thermostats using O or B reversing valve control.
- i. Emergency shutdown contacts.
- j. Boilerless system heat control at low loop water temperature.
- k. Ability to allow up to 3 units to be controlled by one thermostat.
- l. Relay to operate an external damper.
- m. Ability to automatically change fan speed from multistage thermostat.
- n. Relay to start system pump.
- o. 75 VA control transformer. Control transformer shall have load side short circuit and overload protection via a built in circuit breaker.

Digital Night Setback with Pump Restart (DXM w/ ATP32U03/04)

The unit will be provided with a Digital Night Setback feature using an accessory relay on the DXM controller with an ATP32U03/04 thermostat and an external, field-provided time clock. The external time clock will initiate and terminate the night setback period. The thermostat will have a night setback override feature with a programmable override time period. An additional accessory relay on the unit DXM controller will energize the building loop pump control for the duration of the override period. **(Note: this feature requires additional low voltage wiring. Consult Application Drawings for details.)**

Remote Service Sentinel (CXM/DXM)

Solid state control system shall communicate with thermostat to display (at the thermostat) the unit status, fault status, and specific fault condition, as well as retrieve previously stored fault that caused unit shutdown. The Remote Service Sentinel allows building maintenance personnel or service personnel to diagnose unit from the wall thermostat. The control board shall provide a signal to the thermostat fault light, indicating a lockout. Upon cycling the G (fan) input 3 times within a 60 second time period, the fault light shall display the specific code as indicated by a sequence of flashes. A detailed flashing code shall be provided at the thermostat LED to display unit status and specific fault status such as over/under voltage fault, high pressure fault, low pressure fault, low water temperature fault, condensate overflow fault, etc. **Units that do not provide this remote service sentinel shall not be acceptable.**

Option: Lonworks interface system

Units shall have all the features listed above (either CXM or DXM) and the control board will be supplied with a LONWORKS interface board, which is LONMark certified. This will permit all units to be daisy chained via a 2-wire twisted pair shielded cable. The following points must be available at a central or remote computer location:

- a. Space temperature
- b. Leaving water temperature
- c. Discharge air temperature
- d. Command of space temperature setpoint
- e. Cooling status
- f. Heating status
- g. Low temperature sensor alarm
- h. Low pressure sensor alarm
- i. High pressure switch alarm
- j. Condensate sensor alarm
- k. Hi/low voltage alarm

(HB) Series 60Hz Engineering Specifications – Page 5

- l. Fan “ON/AUTO” position of space thermostat as specified above
- m. Unoccupied/occupied command
- n. Cooling command
- o. Heating command
- p. Fan “ON/AUTO” command
- q. Fault reset command
- r. Itemized fault code revealing reason for specific shutdown fault (any one of 7)

This option also provides the upgraded 75VA control transformer with load side short circuit and overload protection via a built in circuit breaker.

Option: MPC (Multiple Protocol Control) interface system

Units shall have all the features listed above (either CXM or DXM) and the control board will be supplied with a Multiple Protocol interface board. Available protocols are BACnet MS/TP, Modbus, or Johnson Controls N2. The choice of protocol shall be field selectable/changeable via the use of a simple selector switch. **Protocol selection shall not require any additional programming or special external hardware or software tools.** This will permit all units to be daisy chain connected by a 2-wire twisted pair shielded cable. The following points must be available at a central or remote computer location:

- a. Space temperature
- b. Leaving water temperature
- c. Discharge air temperature
- d. Command of space temperature setpoint
- e. Cooling status
- f. Heating status
- g. Low temperature sensor alarm
- h. Low pressure sensor alarm
- i. High pressure switch alarm
- j. Condensate overflow alarm
- k. Hi/low voltage alarm
- l. Fan “ON/AUTO” position of space thermostat as specified above
- m. Unoccupied/occupied command
- n. Cooling command
- o. Heating command
- p. Fan “ON/AUTO” command
- q. Fault reset command
- r. Itemized fault code revealing reason for specific shutdown fault (any one of 7)

This option also provides the upgraded 75VA control transformer with load side short circuit and overload protection via a built in circuit breaker.

Warranty:

MARS shall warranty equipment for a period of 12 months from start up or 18 months from shipping (which ever occurs first).

Option: Extended 4-year compressor warranty covers compressor for a total of 5 years.

Option: Extended 4-year refrigeration circuit warranty covers coils, reversing valve, expansion valve and compressor for a total of 5 years.

Option: Extended 4-year control board warranty covers the CXM/DXM control board for a total of 5 years.

FIELD INSTALLED OPTIONS

Hose Kits:

All units shall be connected with hoses. The hoses shall be 2 feet (61cm) long, braided stainless steel; fire rated hoses complete with adapters. Only fire rated hoses will be accepted.

(HB) Series 60Hz Engineering Specifications – Page 6

Valves:

The following valves are available and will be shipped loose:

- a. Ball valve; bronze material, standard port full flow design, FPT connections.
- b. Ball valve with memory stop and PT port.
- c. “Y” strainer with blowdown valve; bronze material, FPT connections.
- d. Motorized water valve; slow acting, 24v, FPT connections.

Hose Kit Assemblies:

The following assemblies ship with the valves already assembled to the hose described:

- a. Supply and return hoses having ball valve with PT port.
- b. Supply hose having ball valve with PT port; return hose having automatic flow regulator valve with PT ports, and ball valve.
- c. Supply hose having “Y” strainer with blowdown valve, and ball valve with PT port; return hose having automatic flow regulator with PT ports, and ball valve.
- d. Supply hose having “Y” strainer with blowdown valve, and ball valve with PT port; return hose having ball valve with PT port.

Thermostats:

The thermostat shall be a MARS mechanical or electronic type thermostat as selected below with the described features:

- a. Single Stage Standard Manual Changeover (ATM11C11)
Thermostat shall be a single-stage, horizontal mount, manual changeover with HEAT-OFF-COOL system switch and fan ON-AUTO switch. Thermostat shall have a mechanical temperature setpoint indicator. Thermostat shall only require 4 wires for connection. Mercury bulb thermostats are not acceptable.
- b. Single Stage Digital Auto or Manual Changeover (ATA11U01)
Thermostat shall be a single-stage, digital, auto or manual changeover with HEAT-OFF-COOL-AUTO system switch and fan ON-AUTO switch. Thermostat shall have an LCD display with temperature and setpoint(s) in °F or °C. The Thermostat shall provide permanent memory of setpoint(s) without batteries. A fault LED shall be provided to display specific fault condition. Thermostat shall provide temperature display offset for custom applications.
- c. Single Stage Digital Automatic or Manual Changeover with Two-Speed Fan Control (ATA11C04) – DXM and PSC Fan required
Thermostat shall be a single-stage, digital, auto or manual changeover with HEAT-OFF-COOL-AUTO system switch, fan ON-AUTO switch, and fan LO-HI switch. Thermostat shall have an LCD display with temperature and setpoint(s) in °F or °C. A fault LED shall be provided to display specific fault condition. Thermostat shall allow use of an accessory remote temperature sensor (AST009), but may be operated with internal sensor via orientation of a jumper.
- d. Multistage Digital Automatic Changeover (ATA22U01)
Thermostat shall be multi-stage (2H/2C), manual or automatic changeover with HEAT-OFF-COOL-AUTO-EM HEAT system settings and fan ON-AUTO settings. Thermostat shall have an LCD display with temperature, setpoint(s), mode, and status indication. The temperature indication shall be selectable for °F or °C. The thermostat shall provide permanent memory of setpoint(s) without batteries. A fault LED shall be provided to indicate specific fault condition(s). Thermostat shall provide temperature display offset for custom applications. Thermostat shall allow unit to provide better dehumidification with optional DXM controller by automatically using lower fan speed on stage 1 cooling (higher latent cooling) as main cooling mode, and automatically shifting to high speed fan on stage 2 cooling.
- e. Multistage Manual Changeover Programmable 5/2 Day (ATP21U01)
Thermostat shall be 5 day/2 day programmable (with up to 4 setpoints per day), multi-stage (2H/1C), manual changeover with HEAT-OFF-COOL-EM HEAT system settings and fan ON-AUTO settings. Thermostat shall have an LCD display with temperature, setpoint(s), mode, and status indication. The temperature indication shall be selectable for °F or °C. The thermostat shall provide permanent memory of setpoint(s) without batteries. Thermostat shall provide convenient override feature to temporarily change setpoint.

(HB) Series 60Hz Engineering Specifications – Page 7

- f. Multistage Automatic or Manual Changeover Programmable 7 Day (ATP32U03)
Thermostat shall be 7 day programmable (with up to 4 setpoints per day), multi-stage (3H/2C), automatic or manual changeover with HEAT-OFF-COOL-AUTO-EM HEAT system settings and fan ON-AUTO settings. Thermostat shall have a blue backlit dot matrix LCD display with temperature, setpoints, mode, and status indication. The temperature indication shall be selectable for °F or °C. Time display shall be selectable for 12 or 24-hour clock. Fault identification shall be provided (when used with MARS CXM or DXM controls) to simplify troubleshooting by providing specific unit fault at the thermostat with red backlit LCD during unit lockout. The thermostat shall provide permanent memory of setpoints without batteries. Thermostat shall provide heating setpoint range limit, cooling setpoint range limit, temperature display offset, keypad lockout, dead-band range setting, and inter-stage differential settings. Thermostat shall provide progressive recovery to anticipate time required to bring space temperature to the next programmed event. Thermostat shall provide an installer setup for configuring options and for setup of servicing contractor name and contact information. Thermostat shall allow the use of an accessory remote and/or outdoor temperature sensor (AST008). Thermostat navigation shall be accomplished via five buttons (up/down/right/left/select) with menu-driven selections for ease of use and programming.
- g. Multistage Automatic or Manual Changeover Programmable 7 Day with Humidity Control (ATP32U04)
Thermostat shall be 7 day programmable (with up to 4 setpoints per day), multi-stage (3H/2C), automatic or manual changeover with HEAT-OFF-COOL-AUTO-EM HEAT system settings and fan ON-AUTO settings. Separate dehumidification and humidification setpoints shall be configurable for discreet outputs to a dehumidification option and/or an external humidifier. Installer configuration mode shall allow thermostat dehumidification mode to operate with ECM fan dehumidification mode via settings changes. Thermostat shall have a blue backlit dot matrix LCD display with temperature, relative humidity, setpoints, mode, and status indication. The temperature indication shall be selectable for °F or °C. Time display shall be selectable for 12 or 24 hour clock. Fault identification shall be provided (when used with MARS CXM or DXM controls) to simplify troubleshooting by providing specific unit fault at the thermostat with red backlit LCD during unit lockout. The thermostat shall provide permanent memory of setpoints without batteries. Thermostat shall provide heating setpoint range limit, cooling setpoint range limit, temperature display offset, keypad lockout, dead-band range setting, and inter-stage differential settings. Thermostat shall provide progressive recovery to anticipate time required to bring space temperature to the next programmed event. Thermostat shall provide an installer setup for configuring options and for setup of servicing contractor name and contact information. Thermostat shall allow the use of an accessory remote and/or outdoor temperature sensor (AST008). Thermostat navigation shall be accomplished via five buttons (up/down/right/left/select) with menu-driven selections for ease of use and programming.

DDC Sensors:

MARS wall mounted DDC sensor to monitor room temperature and interfaces with optional interface system described above.

Several types as described below:

- a. Sensor only with no display (LON and MPC).
- b. Sensor with override (LON only).
- c. Sensor with setpoint adjustment and override (MPC only).
- d. Sensor with setpoint adjustment and override, LCD display, status/fault indication (LON and MPC).

Revision History

Date:	Item:	Action:
04/29/15	Page 41	Updated Notes
03/03/15	Page 16	Updated 018 ECM Performance Data
02/06/15	Page 7	Changed E-Coated to Tin-Plated
02/03/15	All	Updated Rated Airflows ECM
01/21/15	Engineering Specifications	Added ECM Option Text
01/15/15	Pages 39 & 43	Updated Diagram; Added Text
01/05/15	ECM Blower Option	Added
09/30/14	Text Edit - Page 47	Updated
07/15/14	Page 18	Added WPD
06/16/14	Pages 4, 8 & 46	Updated Text & Table
05/29/14	Physical Data Table	Removed Fan Motor (hp)
05/12/14	Physical Data Table	Updated Ref. Charge 024 and Unit Maximum Working Water Pressure
02/11/13	Unit Features	Updated
02/06/13	HBV041 M, N, Q Dimensions page 30	Updated
02/04/13	HBV Right Return Electrical Tables	Updated Blower Orientation
09/27/12	HBH060 Corner Weights Recommended Minimum Installation Clearances for Vertical Units *	Miscellaneous Edits Corrected Added
05/02/12	Size 041	ISO Table Updated
04/30/12	Horizontal Dimensional Data Table	Updated
02/20/12	Engineering Specifications	Updated
01/23/12	Size 041	Added
09/19/11	Size 024	Added "H" and "F" Voltage
08/09/11	Unit Maximum Working Water Pressure	Updated to Reflect New Safeties
08/03/11	Engineering Specifications	Added Digital Night Setback with Pump Restart (DXM w/ ATP32U03/04)
06/17/11	Coated Air Coil Option	Changed Description
04/07/11	Engineering Specification NOTICE	Updated
02/11/11	Performance Data Selection Notes	Updated
01/03/11	Format - All Pages	Updated
09/28/10	Engineering Specifications	Updated
09/28/10	Physical Data Table	Updated-Added Coax Volume Data
09/01/10	012 'E' Airflow Correction Table	Added/Corrected
07/26/10	Wiring Diagrams	Updated
07/26/10	Compressor Mounting Information and Graphics Engineering Specifications	Updated to Reflect Spring/Grommet Change
06/11/10	Format - All Pages	Updated
06/11/10	Engineering Specifications	Updated
04/23/10	Updated (Page 1) of Engineering Specifications	Paragraph edit to update ARI to AHRI
04/22/10	LEED®, EarthPure®	Updated format (®™ etc)
09/25/09	Performance Data Selection Notes	Example Updated
09/09/09	Engineering Specification - Fan 2 Motor Assembly	Changed 'dry' to 'wet'
09/09/09	Engineering Specification - Thermostat	Changed ATP32U01, 02 to 03, 04
09/03/09	Fan and Motor Assembly Engineering Spec.	Changed 'dry' to 'wet'
09/03/09	Thermostat Engineering Spec.	Removed ATP11N01, Changed ATP32U01, 02 to 03, 04
05/27/09	Stand-Alone and Big Book Submittals	Consolidated
05/06/09	Dimensional Data Tables	Condensate Column Added to Water Connections Table, Rows Consolidated in Cabinet, Knockout and Discharge Tables
04/14/09	006-012 unit data added	
02/25/09	First Published	

Due to ongoing product improvements, specifications and dimensions are subject to change and correction without notice or incurring obligations. Determining the application and suitability for use of any product is the responsibility of the installer. Additionally, the installer is responsible for verifying dimensional data on the actual product prior to beginning any installation preparations.

Incentive and rebate programs have precise requirements as to product performance and certification. All products meet applicable regulations in effect on date of manufacture; however, certifications are not necessarily granted for the life of a product. Therefore, it is the responsibility of the applicant to determine whether a specific model qualifies for these incentive/rebate programs.



1900 Wellworth Ave. • Jackson, MI 49203
 517.787.2100 • www.marsdelivers.com • www.heatcontroller.com