

Honeywell

Stryker Lon Configurable Controllers

SPECIFICATION DATA

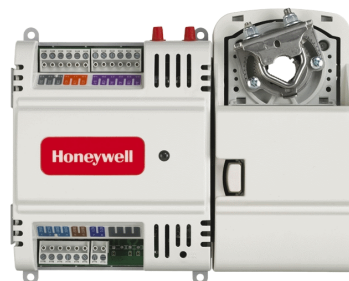
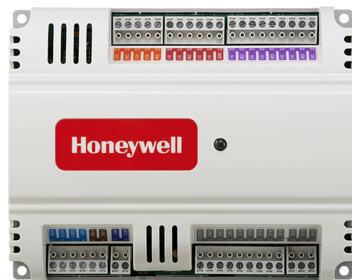

The Stryker controllers require the Stryker Feature to be licensed in the WEBpro workbench tool and the WEBS AX JACE Controller for programming and downloading any brand of the Niagara Workbench or JACE controller.

The controllers are for use in VAV (Variable Air Volume) and CVAHU (Constant Volume Air Handling Unit) control applications. Each controller contains a host microcontroller to run the main HVAC application and a second microcontroller for LONWORKS® network communications. Each controller provides flexible, universal inputs for external sensors, digital inputs, and a combination of analog outputs and digital outputs.

FEATURES

- Uses the Echelon® LONWORKS® network protocol.
- Free Topology Transceiver (FTT) high-speed 78 kilobit communications network.
- Capable of stand-alone operation, but can also use LONWORKS® Bus network communications.
- Sylk™ bus for use with Sylk-enabled sensors.
- 120 controllers per Q7751A,B Router when configured as a repeater.
- Field configurable for control, input, and output functions using the NIAGARA FRAMEWORK® software.
- Built-in Zone Control functions include a remote wMarkall module interface and a scheduler.
- Pressure-independent or pressure-dependent single Variable Air Volume (VAV) control. (CVL4022AS-VAV1 and CVL4024NS-VAV1 only)
- Microbridge air flow sensor with dual integral restrictor design. (CVL4022AS-VAV1 and CVL4024NS-VAV1 only)
- Easy user access to air flow sensor inputs.
- Actuator (CVL4022AS-VAV1 only) mounts directly onto VAV box damper shaft and has up to 44 lb-in. (5 Nm) torque, 90-degree stroke, and 90 second timing at 60 Hz.
- All wiring connections are made to removable terminal blocks to simplify controller installation and replacement.
- Both controller housing and actuator are UL plenum rated

GENERAL

The CUL6438SR-CV1, CVL4022AS-VAV1, and CVL4024NS-VAV1 controllers are part of the Stryker family. The controllers are Free Topology Transceiver (FTT) LONMARK®-certified devices designed to control HVAC equipment. These controllers provide many options and advanced system features that allow state-of-the-art commercial building control. Each controller is configurable using the NIAGARA FRAMEWORK® software.



63-4529-04

DESCRIPTION

The configurable VAV/Unitary controllers are available as described in Table 1.

Table 1. Controller Configurations.

Controller Model	Programmable Type	Universal Inputs (UI)	Digital Inputs (DI)	Analog Outputs (AO)	Digital Outputs (DO)	Velocity Pressure Sensor (Microbridge)	Series 60 Floating Actuator
CUL6438SR-CV1	CVAHU	6	4	3	8 Relay	NO	NO
CVL4022AS-VAV1	VAV	4	0	2	2	YES	YES
CVL4024NS-VAV1	VAV	4	0	2	4	YES	NO

VAV Equipment Control (Models CVL4022AS-VAV1 and CVL4024NS-VAV1)

VAV controllers provide pressure-independent air flow control and pressure-dependent damper control. VAV systems generally provide cool air only to zones. However, each controller has additional programmable inputs and outputs that may be used to control devices, such as a fan or VAV box reheat coils. Heaters can be staged electric or modulating hot water. Supply and exhaust pressurization control are provided on a zone basis.

SPECIFICATIONS

Electrical

Rated Voltage: 20-30 Vac; 50/60 Hz

Power Consumption:

100 VA for controller and all connected loads (including the actuator on model CVL4022AS-VAV1)

Controller only Load: 5 VA maximum; model CVL4024NS-VAV1 and CUL6438SR-CV1

Controller and Actuator Load: 9 VA maximum; model CVL4022AS-VAV1

External Sensors Power Output: 20 Vdc \pm 10% @ 75 mA maximum

Environmental

VAV Operating & Storage Temperature Ambient Rating: (Models CVL4022AS-VAV1 and CVL4024NS-VAV1)
Minimum 32° F (0° C); Maximum 122° F (50° C)

CVAHU Operating & Storage Temperature Ambient Rating (Model CUL6438SR-CV1):

Minimum: -40° F (-40° C); Maximum: 150° F (65.5° C)
Relative Humidity: 5% to 95% non-condensing

Dimensions (H/W/D)

See Fig. 3 and Fig. 4 beginning on page 6 for dimension drawings.

Approval Bodies

UL/cUL (E87741) listed under UL916 (Standard for Open Energy Management Equipment) with plenum rating.

CSA (LR95329-3) listed.

Meets FCC Part 15, Subpart B, Class B (radiated emissions) requirements.

Meets Canadian standard C108.8 (radiated emissions).

EMC Directive: 2014/30/EU:

Standards Applied:

- IEC 61000-4-8:2009
- IEC 61000-4-11:2004
- EN 61000-6-1: 2007; EN 61000-6-3:2007/A1:2011; EN 61000-6-3:2007/A1:2011/AC: 2012
- EN 60730-2-9: 2010, EN 60730-2-14: 1997 + EN60730-2-14/A1: 2001.
- In conjunction with EN 60730-2-9:2010 and in conjunction with EN 60730-2-14:1997 and amendments: EN 60730-1: 2000 + A1: 2004 + A16: 2007 + A2: 2008 -Annex H.26.

RoHS Directive: 2011/65/EU

Standards Applied:

- EN 50581: 2012

Regulatory Compliance Mark (RCM) declaration in Australia

Real Time Clock

Operating Range: 24 hour, 365 day, multi-year calendar including day of week and configuration for automatic daylight savings time adjustment to occur at 2:00 a.m. local time on configured start and stop dates

Power Failure Backup: 24 hours at 32 to 100° F (0 to 38° C), 22 hours at 100 to 122° F (38 to 50° C)

Accuracy: \pm 1 minute per month at 77° F (25° C)

Velocity Pressure Sensor (Models CVL4022AS-VAV1 and CVL4024NS-VAV1)

Operating Range: 0 to 1.5 in. H₂O (0 to 374 Pa)

Series 60 Floating Actuator (Model CVL4022AS-VAV1)

Rotation Stroke: 95° ± 3° for CW or CCW opening dampers
 Torque Rating: 44 lb-in. (5 Nm)
 Run Time for 90° rotation: 90 seconds at 60 Hz

Inputs and Outputs

Each controller has a combination of universal inputs (UI), digital inputs (DI), analog outputs (AO), and digital outputs (DO) as listed in Table 1.

Digital Input (DI) Circuits

Voltage Rating: 0 to 30 Vdc open circuit
 Input Type: Dry contact to detect open and closed circuit
 Operating Range: Open circuit = False; Closed circuit = True
 Resistance: Open circuit > 3,000 Ohms; Closed circuit < 500 Ohms

Digital Triac Output (DO) Circuits

Voltage Rating: 20 to 30 Vac @ 50-60Hz
 Current Rating: 25 mA to 500 mA continuous, 800 mA (AC rms) for 60 milliseconds

Digital Relay Output (DO) Circuits (CUL6438SR-CV1 Only)

Voltage Rating: 20 to 30 Vac @ 50-60Hz
 Current Rating: 0 mA to 1A continuous, 3.5A inrush (AC rms) for 100 milliseconds

Analog Output (AO) Circuits

Analog outputs can be individually configured for current or voltage.

ANALOG CURRENT OUTPUTS:

Current Output Range: 4.0 to 20.0 mA
 Output Load Resistance: 550 Ohms maximum

ANALOG VOLTAGE OUTPUTS:

Voltage Output Range: 0 to 10.0 Vdc
 Maximum Output Current: 10.0 mA

Analog outputs may be configured as digital outputs and operate as follows:

- False (0%) produces 0 Vdc, (0 mA)
- True (100%) produces the maximum 11 Vdc, (22 mA)

Universal Input (UI) Circuits

See Table 2 for the UI specifications.

Table 2. Universal Input Circuit Specifications.

Input Type	Sensor Type	Operating Range
Room/Zone Discharge Air Outdoor Air Temperature	20K Ohm NTC	-40° F to 199° F (-40° C to 93° C)
Outdoor Air Temperature	C7031G ^a	-40° to 120°F (-40° to 49°C)
	C7041F ^a	-40° to 250°F (-40° to 121°C)
	PT1000 (IEC751 3850)	-40° F to 199° F (-40° C to 93° C)
TR23 Setpoint Potentiometer	500 Ohm to 10,500 Ohm	-4° DDC to 4° DDC (-8° DDF to 7° DDF) or 50° F to 90° F (10° C to 32° C)
Resistive Input	Generic	100 Ohms to 100K Ohms
Voltage Input	Transducer, Controller	0-10 Vdc
Discrete Input	Dry Contact closure	OpenCircuit ≥ 3000Ohms ClosedCircuit < 3000Ohms

^a C7031G and C7041F are recommended for use with these controllers, due to improved resolution and accuracy when compared to the PT1000.

Hardware

CPU

Each controller uses a Texas Instruments MSP430 family microprocessor. The processor contains on-chip FLASH program memory, FLASH information memory, and RAM.

Memory Capacity

Flash Memory: 116 kilobytes with 8 kilobytes available for user program. The controller is able to retain FLASH memory settings for up to ten (10) years.

RAM: 8 kilobytes

Status Information

The LED on the front of the controller provides a visual indication of the status of the device. When the controller receives power, the LED appears in one of the following allowable states, as described in Table 3.

Table 3. Status LED States.

LED State	Blink Rate	Status or Condition
OFF	not applicable	No power to processor, LED damaged, low voltage to board, or controller damaged.
ON	ON steady; not blinking	Processor and/or controller is not operating.
Very slow blink (continuous)	1 second ON, 1 second OFF	Controller is operating normally.
Slow blink (continuous)	0.5 second ON, 0.5 second OFF	Controller alarm is active, controller in process of download, or controller lost its configuration.
Medium blink (continuous)	0.25 second ON, 0.25 second OFF	Controller firmware is loading.
Fast blink (continuous)	0.10 second ON, 0.10 second OFF	Controller is in manual mode under control of the PC-based software tool.

Communications

Each controller uses an FTT transformer-coupled communications port. The controller's Manchester encoded data is presented to other controllers and devices on the LONWORKS® Bus at 78 kilobits per second (kbs) via Echelon® communication protocol. The transformer-coupled communications interface offers a much higher degree of common mode-noise rejection while assuring dc isolation. The LONWORKS® Bus is polarity insensitive, eliminating installation errors due to miswiring.

The maximum LONWORKS® Bus network length is 4,600 ft. (1,400 m). For LONWORKS® Bus network lengths greater than the above, see "LONWORKS® Bus Wiring Guidelines," form no. 74-2865.

The theoretical limit for each LONWORKS® Bus segment is 60 controllers. Up to 120 controllers can be configured when the Q7751A,B Router (configured as a repeater) is used, and the bus must be either singly or doubly terminated. Actual installations may have a lower limit, depending on the devices connected.

Honeywell-provided cable types for LONWORKS® Bus communications wiring are Level IV 22 AWG (0.34 sq. mm) plenum or non-plenum rated unshielded, twisted pair, stranded conductor wire.

- For non-plenum areas, U.S. part AK3798 (single-pair stranded) can be used.
- For plenum areas, U.S. part AK3797 (single-pair stranded) or U.S. part AK3799 (two-pair stranded) can be used.

Contact Echelon Corp. Technical Support for the recommended vendors of Echelon approved cables.

Refer to the "LONWORKS® Bus Wiring Guidelines," form 74-2865, for a complete description of LONWORKS® Bus network topology rules and approved cable types.

If a longer LONWORKS® Bus network is required, the Q7751A,B Router (configured as a repeater) can be added to extend the length of the LONWORKS® Bus. Each network segment can have a maximum of one repeater.

NOTE: Connection for operator access to the LONWORKS® Bus is provided by plugging the USB LONTALK® Adapter connector into the LONWORKS® Bus jack on the controller.

Sylk™ Bus

Sylk is a two wire, polarity insensitive bus that provides both 18 Vdc power and communications between a Sylk-enabled sensor and a Sylk-enabled controller. Using Sylk-enabled sensors saves I/O on the controller and is faster and cheaper to install since only two wires are needed and the bus is polarity insensitive.

Network Variables Profile

Network variables, as described in the following illustrations, are communicated over the LONWORKS® Bus.

The network variable prefixes have the following meaning:

- nvi – Network Variable Input
- nvo – Network Variable Output

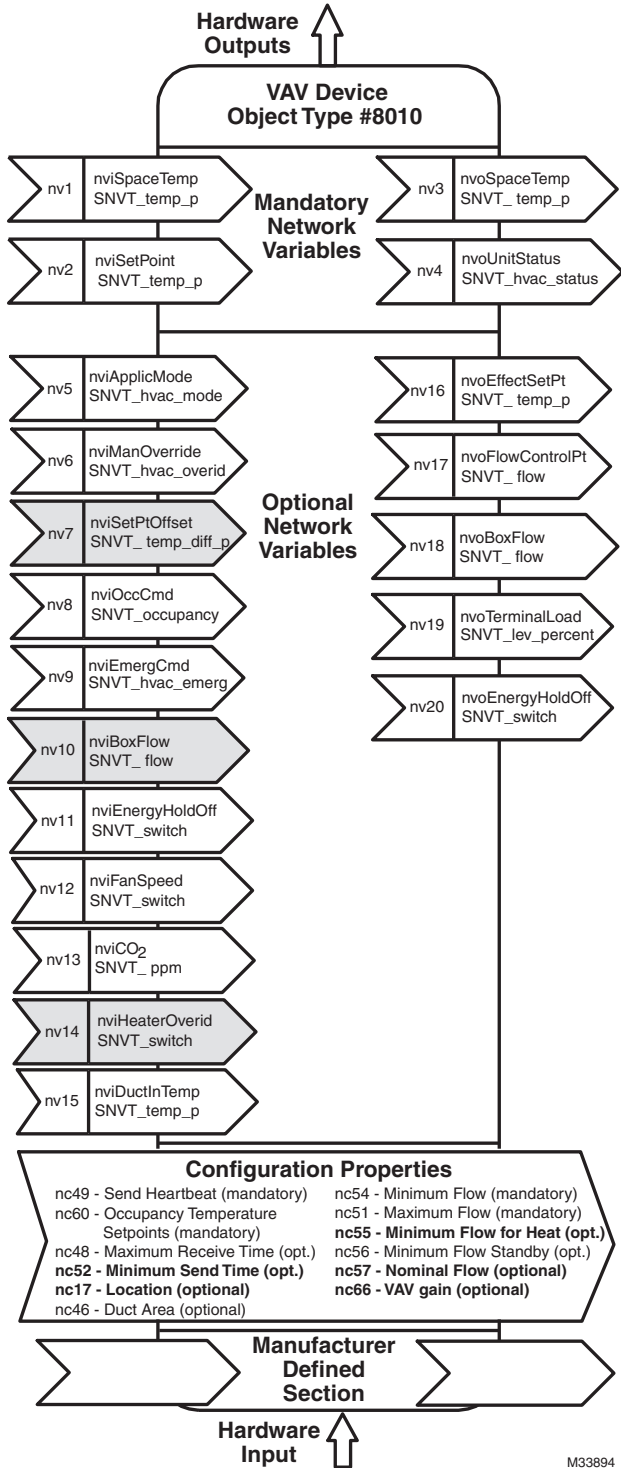

Fig. 1. Network variables for VAV Controllers.

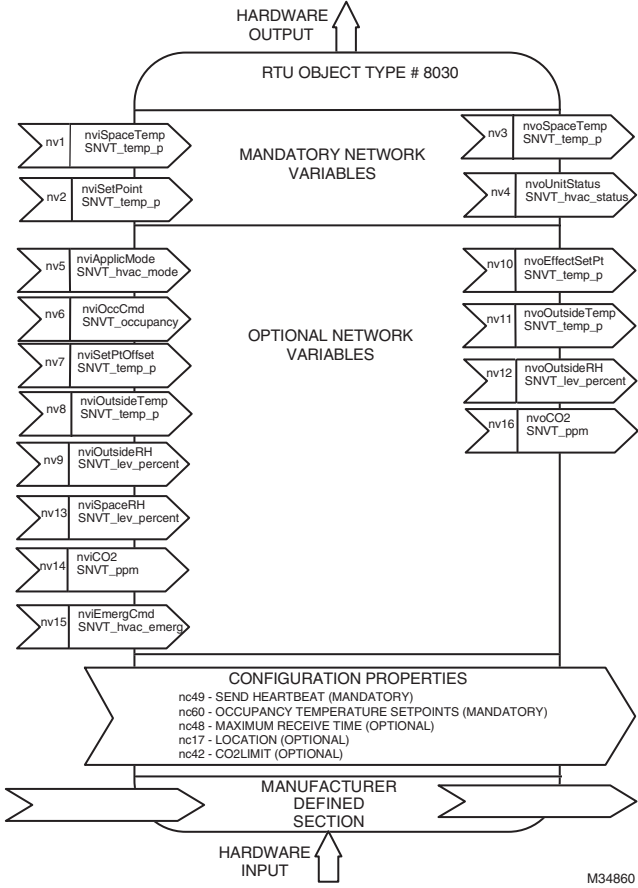

Fig. 2. Network variables for CVAHU Controllers.

Accessories

- 201052A,B,C Auxiliary Switches (one, two or three switches)
- 209541B Termination Module
- C7770A Air Temperature Sensor (indoor/plenum)
- C7031G Air Temperature Sensor (outdoor)
- C7041F Air Temperature Sensor (outdoor)
- Q7751A,B Router (configured as a repeater)
- TR71/75 Zio Wall Module
- TR2X Wall Module
- C7400A Enthalpy Sensor
- P7640 Pressure Transducer Family
- C7232 CO₂ Sensor Family
- C7600 Humidity Sensor Family
- H7625, H7635, and H7655 Humidity and Temperature Sensors

Refer to the “Sensors Product Overview,” form 63-9285, for additional accessories.

Mounting

The controller enclosure is constructed of a plastic base plate and a plastic factory-snap-on cover. The cover does not need to be removed from the base plate for either mounting or wiring. Removable terminal blocks are used for all wiring connections, which allow the controller to be wired before or after mounting.

The controller can be mounted in any orientation. Ventilation openings are designed into the cover to allow proper heat dissipation regardless of the mounting orientation.

NOTE: The controller must be mounted in a position that allows clearance for wiring, servicing, removal, connection of the LONWORKS® Bus Jack, and access to the NEURON® Service Pin.

NOTE: For complete mounting information, refer to the "Installation Instructions," form 62-2029.

CVL4022AS-VAV1 Mounting

The CVL4022AS-VAV1 controller includes the direct-coupled actuator with Declutch mechanism, which is shipped hard-wired to the controller.

The actuator mounts directly onto the VAV box damper shaft and has up to 44 lb-in. (5 Nm) torque, 90-degree stroke, and 90 second timing at 60 Hz. The actuator is suitable for mounting onto a 3/8 to 1/2 in. (10 to 13 mm) square or round VAV box damper shaft. The minimum VAV box damper shaft length is 1-9/16 in. (40 mm).

After the actuator is mounted onto the damper shaft, the controller mounts to a panel by using four No. 6 or No. 8 machine or sheet metal screws inserted through the corners of the base plate.

CUL6438SR-CV1 and CVL4024NS-VAV1 - Mounting

These controllers mount to either a panel or DIN rail (standard EN50022; 7.5 mm x 35 mm).

- For panel mounting, use four No. 6 or No. 8 machine or sheet metal screws inserted through the corners of the base plate.
- For DIN rail mounting, refer to the "Installation Instructions," form 62-2029.

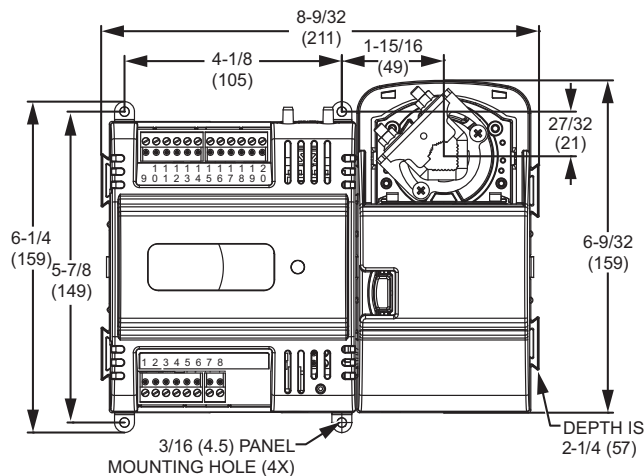

NOTE: CONTROLLER CAN BE MOUNTED IN ANY ORIENTATION. M28648

Fig. 3. Panel mounting – controller and actuator dimensions in inches (mm) for CVL4022AS-VAV1.

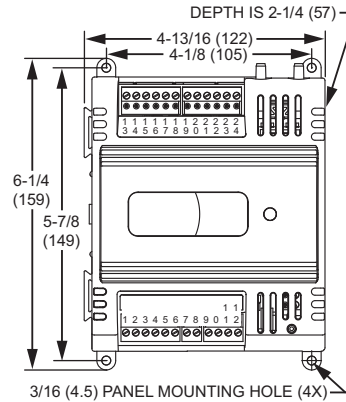

NOTE: CONTROLLER CAN BE MOUNTED IN ANY ORIENTATION. M33864

Fig. 4. Panel mounting – controller dimensions in inches (mm) for CVL4024NS-VAV1.

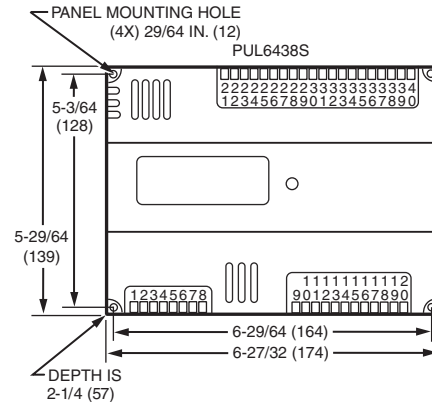

NOTE: CONTROLLER CAN BE MOUNTED IN ANY ORIENTATION. M34861

Fig. 5. Panel mounting – controller dimensions in inches (mm) for CUL6438SR-CV1.

By using this Honeywell literature, you agree that Honeywell will have no liability for any damages arising out of your use or modification to, the literature. You will defend and indemnify Honeywell, its affiliates and subsidiaries, from and against any liability, cost, or damages, including attorneys' fees, arising out of, or resulting from, any modification to the literature by you.

Automation and Control Solutions

Honeywell International Inc.
1985 Douglas Drive North
Golden Valley, MN 55422
customer.honeywell.com

® U.S. Registered Trademark
© 2016 Honeywell International Inc.
63-4529-04 M.S. Rev. 10-16
Printed in United States

Honeywell