



Hydronic Heating and Plumbing Products

A-50M

 **Bell & Gossett**
a xylem brand

The Most Complete Line of Hydronic Heating and Plumbing Products.

All from a Single Source - Bell & Gossett.



Table of Contents

Page Number

Pumps

ecocirc Series Heating Pump	4
LS Condensate Removal Pump	5
ecocirc ³ Series	6
autocirc ³ Series	7
ecocirc SC Solar Pump	8-9
NRF (Cast Iron, Maintenance-Free Wet Rotor)	10-11
NBF (Bronze, Maintenance-Free Wet Rotor)	12-13
SSF (Stainless Steel, Maintenance-Free Wet Rotor)	12-13
Series LR™ (Compact Maintenance-Free)	13
Series PL™ (Maintenance-Free Dry Motor)	14
Three Piece - Oil Lubricated Series 100, HV, PR, 2", 2-1/2" LD-3, HD-3, PD-35, PD-37, PD-38, PD-40	15
Series 60 (In-Line Mounted)	16-17

Pump Accessories

Flanges	18
Check-Trol™ Isolation Flow Control Flange	18
Isolation Flanges	19

Controls

ecocirc ³ Series Timer	20
Aquastats and Timer	20
NRF-VS Variable Speed Control	21
AZ Snap-On Pump Control	22
ZONETROL™ Switching Relays	22-23

Valves

Circuit Setter® Plus	24
Circuit Sentry™ Flo-Setter™	25
Flow Control Valves (Flo-Control™)	26
(Hydrotrol™)	27
Differential Bypass Valves	27
Pressure Reducing Valves	28
ASME Safety Relief Valves	28
Monoflo® Fittings	29

Air Separators

IAS (Inline Air Separators)	29
EAS (Enhanced Air Separator)	30
EASB-JR (Enhanced Air Separator)	30

Hydronic Specialties

Air Vents	31
Vacuum Breaker	31
Drain-O-Tank® Air Charger	31
Thermoflo® Balancer	31
Primary/Secondary Header	32

Tanks

HFT Pre-Charged Hydronic Heating Tanks	33
Plain Steel Compression Tanks	33
ATF (Airtrol® Tank Fittings)	33
PT Diaphragm Tanks	34
WTX Diaphragm Tanks	34
Tank Purge Valves	35

Heat Exchangers

Brazed Plate Heat Exchangers	36-37
------------------------------------	-------

Waste Water Pumps

Sump, Effluent, Sewage, Grinder Pumps	38
---	----

CIRCULATORS ecocirc® auto and vario

Heating Circulator

Description

ecocirc® 19-14 auto and vario circulators were designed with highly efficient electronically commutated permanent magnet motor (ECM/PM technology) specifically for hydronic systems.

Materials of Construction

Pump Body: Cast Iron
 O-Ring: EPRM
 Bearing: Carbon/Alumina Ceramic
 Impeller: Nylon/PPO
 Motor: High Efficiency ECM/PM
 All Other Wetted Parts: Stainless Steel

Operating Data

Maximum Working Pressure: 150 PSI (10 Bar)
 Maximum Working Temperature: 203°F (110°C)
 Minimum Working temperature: 50°F (10°C)

Motor

ECM/PM Spherical Motor
 115 Volts, 60 HZ, 1 Phase
 60 Watts Max Power Consumption
 Automatic Overload Protection
 Low in-rush current

Piping Connection

Flanged, 2-Bolt
 For use with ¾, 1, 1¼, or 1½ inch pipe

Dry Run Protection

The ecocirc® 19-14 is protected against dry run condition. The circulator recognizes when there is no water in the pump housing and automatically stops the pump until the presence of water is detected.

Step-less speed switch with LED for pump status and troubleshooting

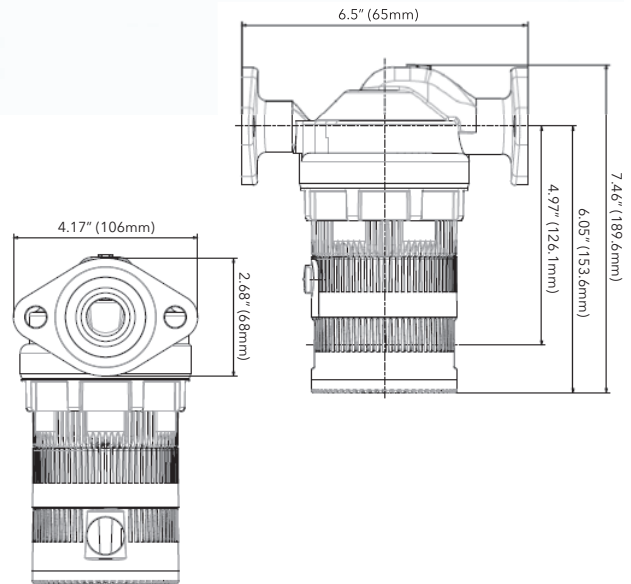

Pump curves ecocirc®

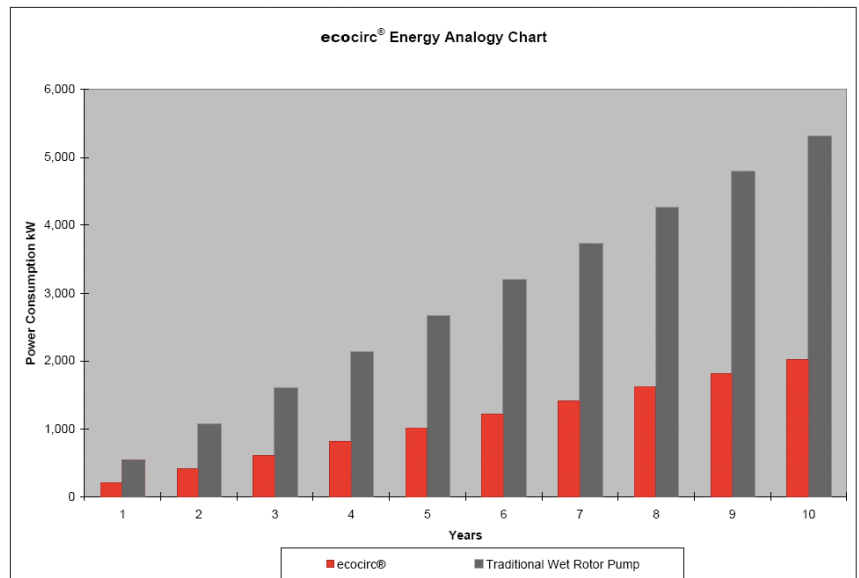
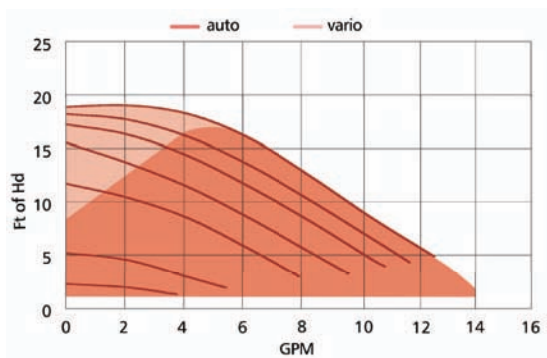

Part Number	Model	Control Mode	Shipping Weight
6050B2000	ecocirc 19-14 auto	auto - Proportional Pressure	9.25 lb
6050B2001	ecocirc 19-14 vario	vario - Constant Curve	9.25 lb

CIRCULATORS LS Condensate Removal Pump

For Condensing Boilers and Air Conditioning /Cooling Systems

Description

The LS condensate removal pumps are energy efficient lifting stations that use permanent magnet, ECM (electronically commutated motor) technology. The LS condensate removal pumps are designed specifically for use in applications where the removal of condensate fluid is not possible by gravity.

Materials of Construction

Pump Housing: ABS Material
 O-Ring: EPDM or Viton
 Bearing: Carbon/Alumina Ceramic
 Impeller: Nylon/PPO
 Motor: High Efficiency ECM
 All Other Wetted Parts: Type 316 Stainless Steel
 Shaft-less, seal-less construction



Standard Features

Motors are designed with a shaft-less spherical motor with permanent technology for improved efficiency.

Motor

ECM Spherical Motor
 Phase: Single 50/60 Hz
 Voltage: 100-240 volts
 Power Consumption: 20 watts
 Current draw: 0.1 - 0.2A
 Automatic Overload Protection
 Low in-rush current

Acid Resistant

All LS condensate removal pumps are made from acid resistant ABS material

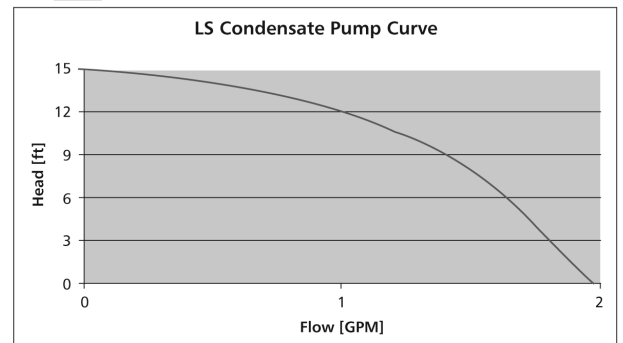
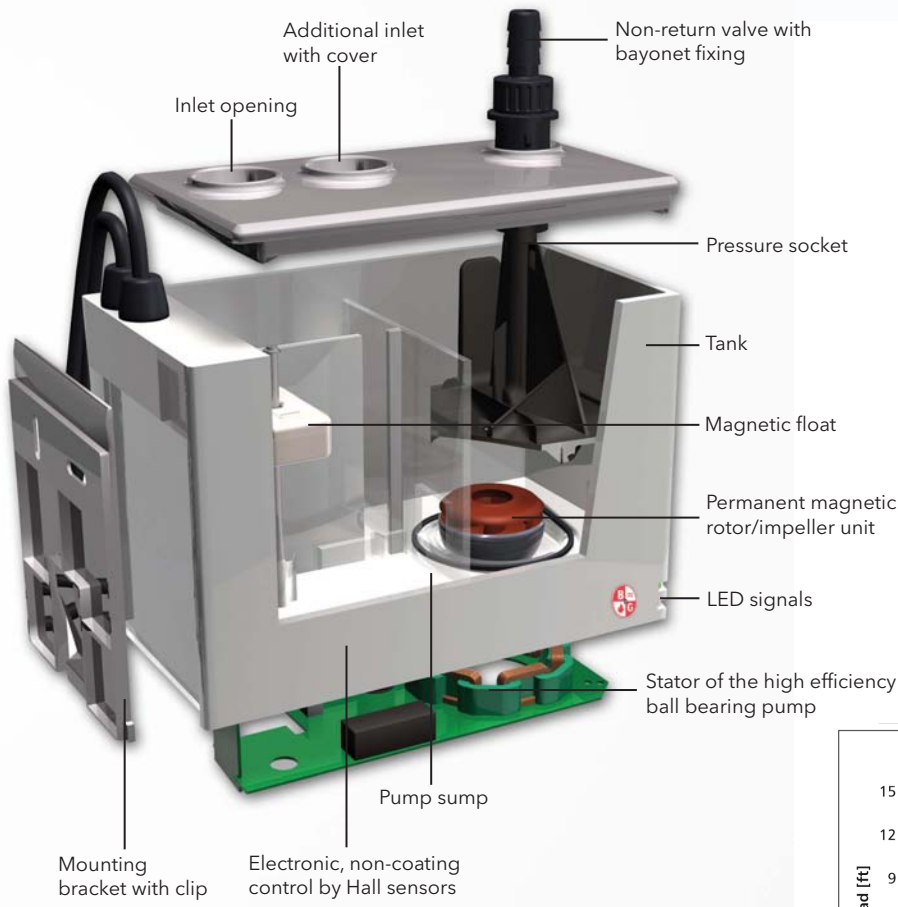

Part Number	Model	Materials		Motor	Weight
		Housing	Sweat		
6098B0000	LS Condensate Pump	ABS	SWEAT	ECM	3.5 lbs

CIRCULATORS ecocirc® SERIES

Potable Hot Water Recirculation Pumps - Whole House

Description

e³ circulators are energy efficient circulators using permanent magnet, ECM (electronically commutated motor) technology. The e³ circulators are designed specifically for potable water applications. These circulators are lead free* and come with a variety of options including a temperature sensor, various body styles, assembled with electrical cord and plug, timer and more.

Materials of Construction

Pump Body: Lead Free* Brass
 O-Ring: EPDM or Viton
 Bearing: Carbon/Alumina Ceramic
 Impeller: Nylon/PPO
 Motor: High Efficiency ECM
 All Other Wetted Parts: Type 316 Stainless Steel
 Shaft-less, seal-less construction

Operating Data

Pump

Maximum Working Pressure: 150 PSI (10.3 Bar)
 Maximum Working Temperature: 230°F (110°C)
 Minimum Working temperature: 50°F (10°C)

Motor

ECM Spherical Motor
 100-240V 50/60HZ
 5-28 Watts Power Consumption
 Automatic Overload Protection
 Low in-rush current

Pump Curves

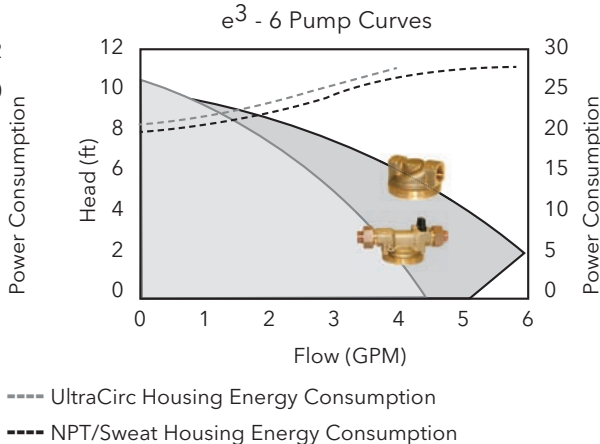
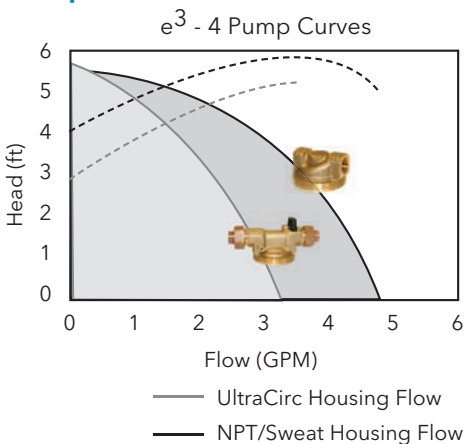

Adjustable Speed Switch (Models Without Temp Sensor)

Infinitely variable-speed switch to manually adjust motor speed.

Adjustable Temperature Sensor (Fixed Speed Only)

Adjustable Set Point from 68 to 158°F (20° to 70°C)
 Turns circulator OFF when water temperature reaches set point
 Turns circulator ON when water temperature is 10°F (6°C) below set point

Connections

1/2" UltraCirc
 1/2" Sweat
 1/2" FNPT Threaded

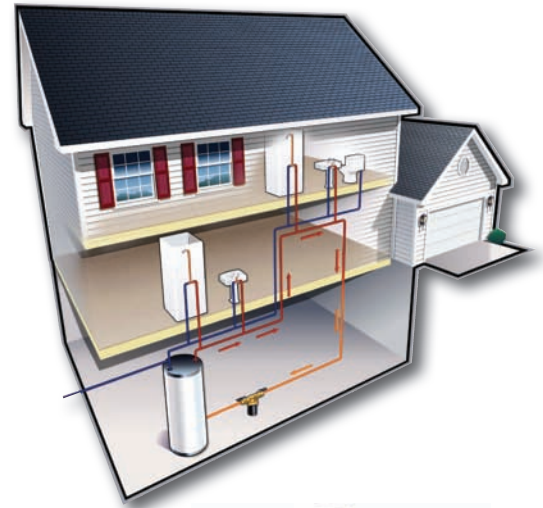

UltraCirc Pump Housing (Union with Ball & Check Valve)

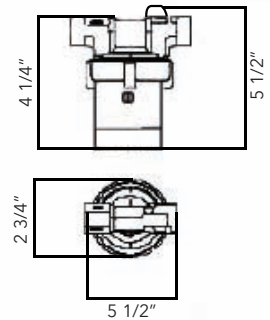

Standard Pump Housing (Sweat & Threaded)

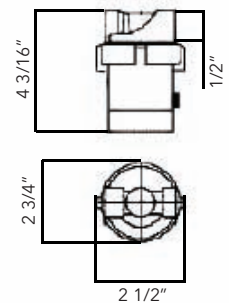

Model Number	Part Number	Materials	Connection		Adjustable Speed	Adjustable Thermostat	Plug
			Size	Type			
e ³ -4V/BSPYZ	LHB08100101	Lead-Free Brass	1/2"	Sweat	•		•
e ³ -4V/BSXRZ	LHB08100102	Lead-Free Brass	1/2"	Sweat		•	
e ³ -4V/BTXYZ	LHB08100104	Lead-Free Brass	1/2"	FNPT	•		
e ³ -4V/BTPRZ	LHB08100106	Lead-Free Brass	1/2"	FNPT		•	•
e ³ -4V/BUPYZ	LHB08100107	Lead-Free Brass	1/2"	Union	•		•
e ³ -4V/BUPRZ	LHB08100108	Lead-Free Brass	1/2"	Union		•	•
e ³ -6V/BSPYZ	LHB08100109	Lead-Free Brass	1/2"	Sweat	•		•
e ³ -6V/BTXYZ	LHB08100112	Lead-Free Brass	1/2"	FNPT	•		
e ³ -6V/BTPYZ	LHB08100110	Lead-Free Brass	1/2"	FNPT	•		•
e ³ -6V/BUPYZ	LHB08100111	Lead-Free Brass	1/2"	Union	•		•
e ³ -Timer	LHB08260002						

CIRCULATORS autocirc® SERIES

Potable Hot Water Recirculation Pumps - Undersink

Description

autocirc® circulators are energy efficient using permanent magnet, ECM (electronically commutated motor) technology. The autocirc circulators are designed specifically for standard water heaters. These circulators are lead free and are assembled with a timer, cord and plug.

Materials of Construction

Pump Body: Lead Free* Brass
 O-Ring: EPDM
 Bearing: Carbon/Ceramic
 Impeller: Nylon/PPO
 Motor: High Efficiency ECM
 All Other Wetted Parts: Type 316 Stainless Steel,
 Shaft-less Seal-less construction.

Operating Data

Pump

Maximum Working Pressure: 145 PSI (10 Bar)
 Maximum Working Temperature: 203°F (95°C)
 Minimum Working Temperature: 50°F (10°C)

Motor

ECM Spherical Motor
 115 Volt 60 Hz
 14 Watts Power Consumption
 Automatic Overload Protection
 Low in-rush current

Energy Efficient:

- Electronically Commutated Motor (ECM) provides significant energy savings.
- Microprocessor technology for optimum performance.
- Permanent magnet motor reduces power consumption.
- Only moving part is a spherical rotor/impeller unit suspended on a wear resistant ceramic ball.
- Reduced power consumption, CO₂ emissions and wasted water.
- Instant hot water at every faucet with as little as 14 watts!

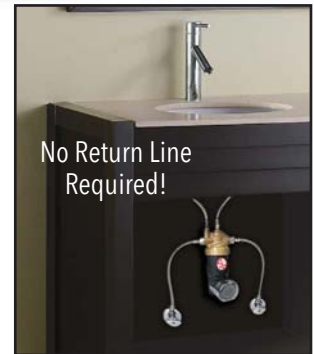

Installs within minutes, directly under the sink.

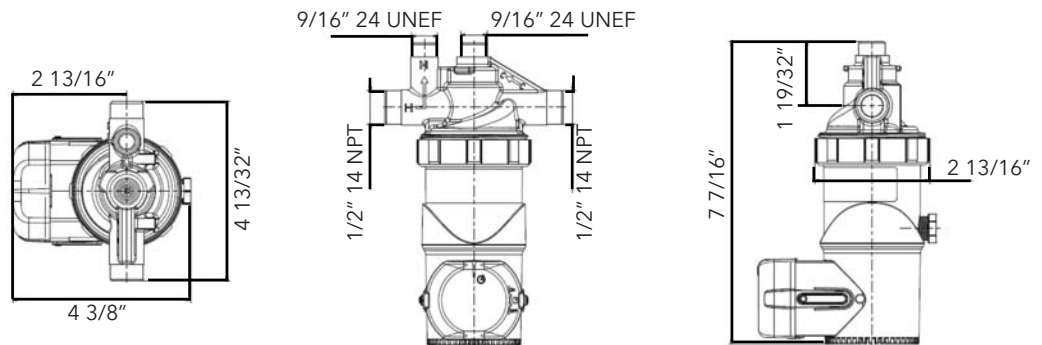

Model Number	Part Number	Description	Weight
e ³ -4V_-/BDPQC	LHB08100098	Lead-Free Brass Autocirc 1/2" Fixed Thermostat with Timer	4lbs.
e ³ -4V_-/BDPRC	LHB08100099	Lead-Free Brass Autocirc 1/2" Adjustable "ON" Thermostat with Timer	4lbs.

Less than 0.25% Pb on wetted parts surface areas.

CIRCULATORS ecocirc® SC Solar Pump

Spherical Motor Pump

Application

- The ecocirc solar pump can be used for most circulation pump applications without connection to the power grid with direct connection a photovoltaic panel.
- This pump is perfect for single family home thermal solar systems or any circulation pump application where conventional power is not available.

Design

- The only moving part is a hemispherical rotor/impeller unit which sits on an ultra-hard, wear-resistant ceramic ball.
- There are no conventional shaft bearings or seals eliminating bearing noise and seal leaks.
- This pump is robust and has an estimated service life in excess of 50,000 hours.
- The self-realigning bearing is lubricated and cooled by the media.
- Even after prolonged shutdown, the pump will start reliably.
- All parts exposed to the fluid are completely corrosion resistant.

Soft Start-up

- When the photovoltaic panel provides sufficient power, the pump goes through the alignment phase by turning the rotor into the position required for start-up.
- The processor then waits until the capacitor is sufficiently charged.
- This enables a start-up with minimal power (less than one watt).

Over-temperature Safety Device

- The ecocirc Solar pump comes with an integrated over-temperature safety device which shuts off the pump electronics when reaching temperatures over 230°F.
- When the temperature of the pumped fluid is below 203°F the pump will function normally.
- The temperature of the electronic components is influenced by the temperature of the pumped media and by the speed setting.
- After reaching a critical temperature 203°F the pump will lower its speed automatically in order to avoid a total shutdown.
- However, if the temperature continues to rise the pump will eventually shut down completely and automatically restart after cooling down.

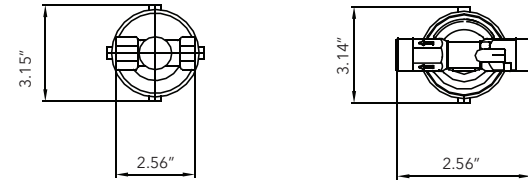
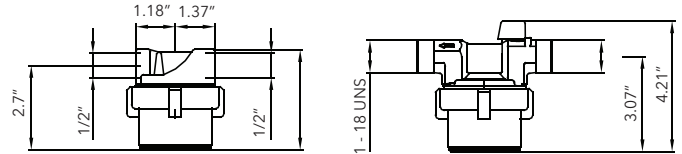
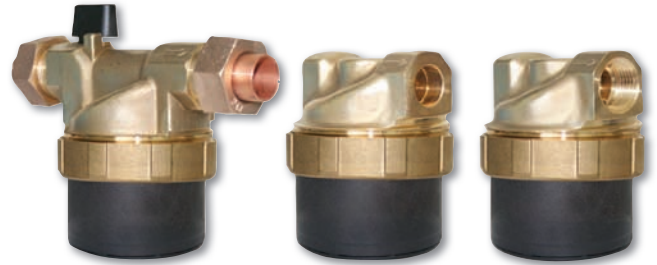

e³-SC6N and e³-SC6S

e³-SC4U

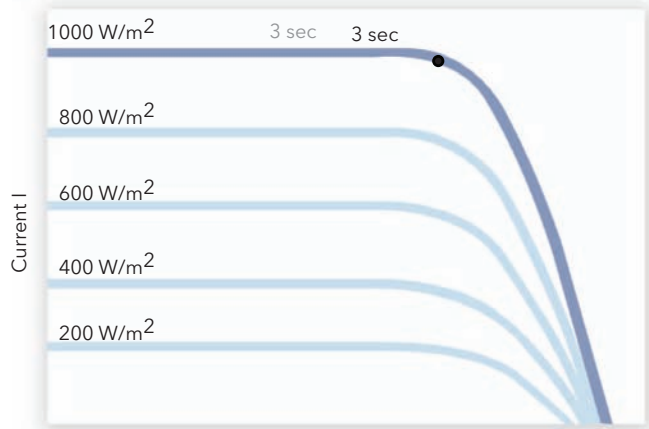

Voltage U

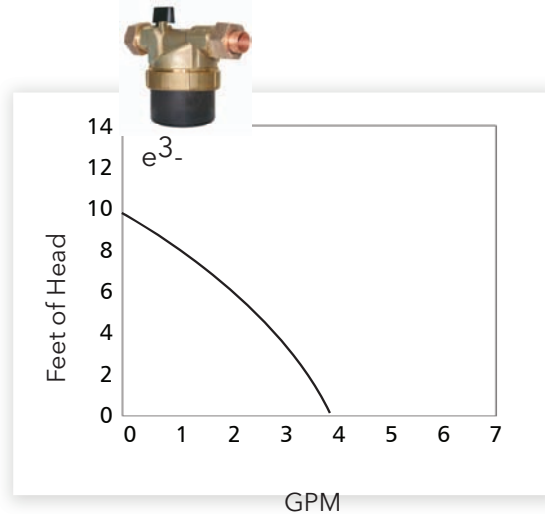
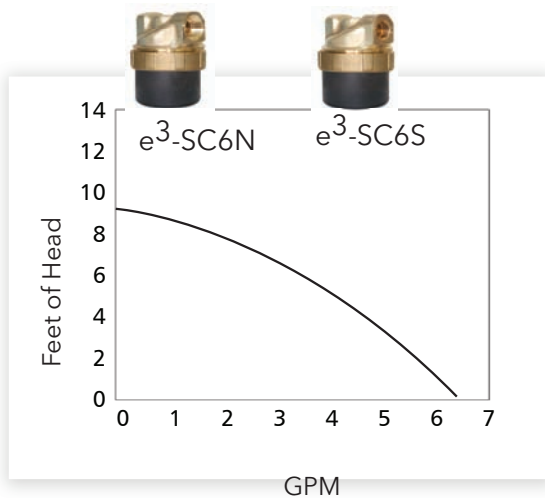

CIRCULATORS ecocirc® SC Solar Pump

Spherical Motor Pump

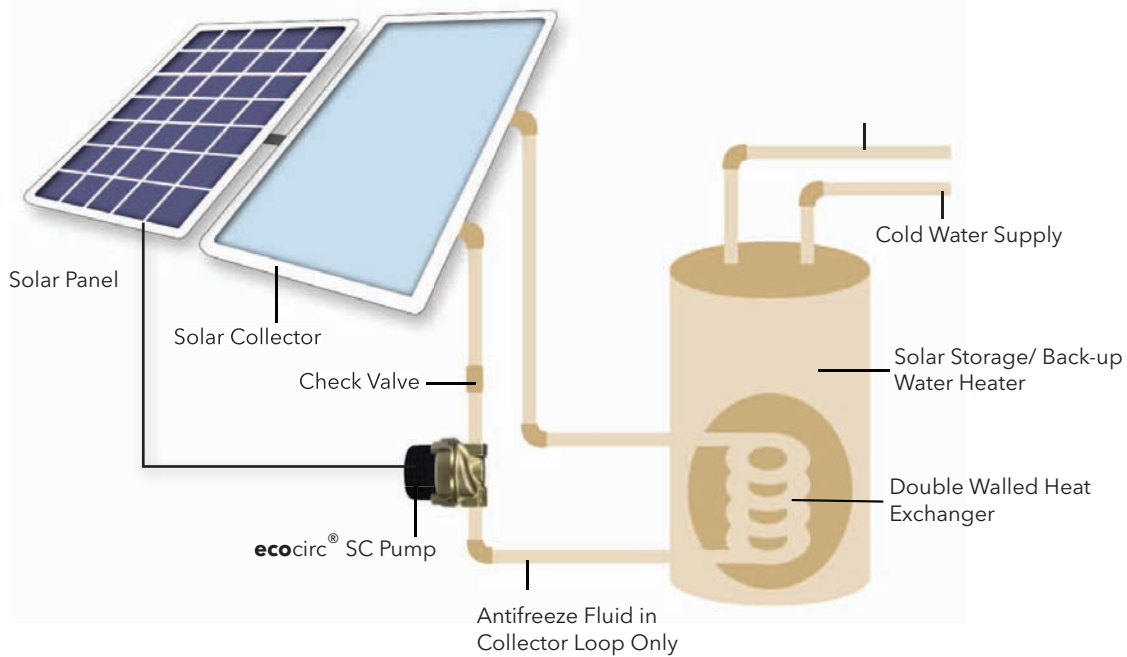

Technical Data

Motor Design:	Electronically commutated spherical motor with permanent magnet rotor/impeller
Voltage:	12 - 24 Volt
Power Consumption*:	Min. start-up power consumption less than 1 Watt, max. power consumption 22 Watts
Current Draw:	0.25 - 1.46 A
Acceptable Media:	Potable hot water recirculation, heating water, water/glycol mixtures, other media on request**
Environment:	IP 42
Insulation Class:	Class F

* Power consumption and start may vary in different installations

**please check pump performance with more than 20 % glycol

Model	Pump Housing Material	Maximum System Temperature	Housing Design	Connection	Maximum Pressure
e ³ -SC6S	Brass	230°F	Inline	1/2" Sweat connection	150 PSI
e ³ -SC6N	Brass	230°F	Inline	1/2" Female pipe thread	150 PSI
e ³ -SC4U	Brass	230°F	Inline/BV+CV+PV*	1/2" Union sweat	150 PSI

* Built-in ball check valve and purge valve

Available Models

Part Number	Description	Model	Weight
6055B2000	Lead Free Brass* Solar Circulator 1/2" Sweat	e ³ -SC6S	2lbs.
6055B2001	Lead Free Brass* Solar Circulator 1/2" NPT	e ³ -SC6N	2lbs.
6055B2002	Lead Free Brass* Solar Circulator 1/2" Union Sweat	e ³ -SC4U	2lbs.

*Less than 0.25% Pb by weight on wetted parts surface areas.

CIRCULATORS Bell & Gossett Cast Iron Wet Rotor Circulators / NRF

Reliable, maintenance-free, whisper quiet wet rotor circulators designed for residential and light commercial heating systems.

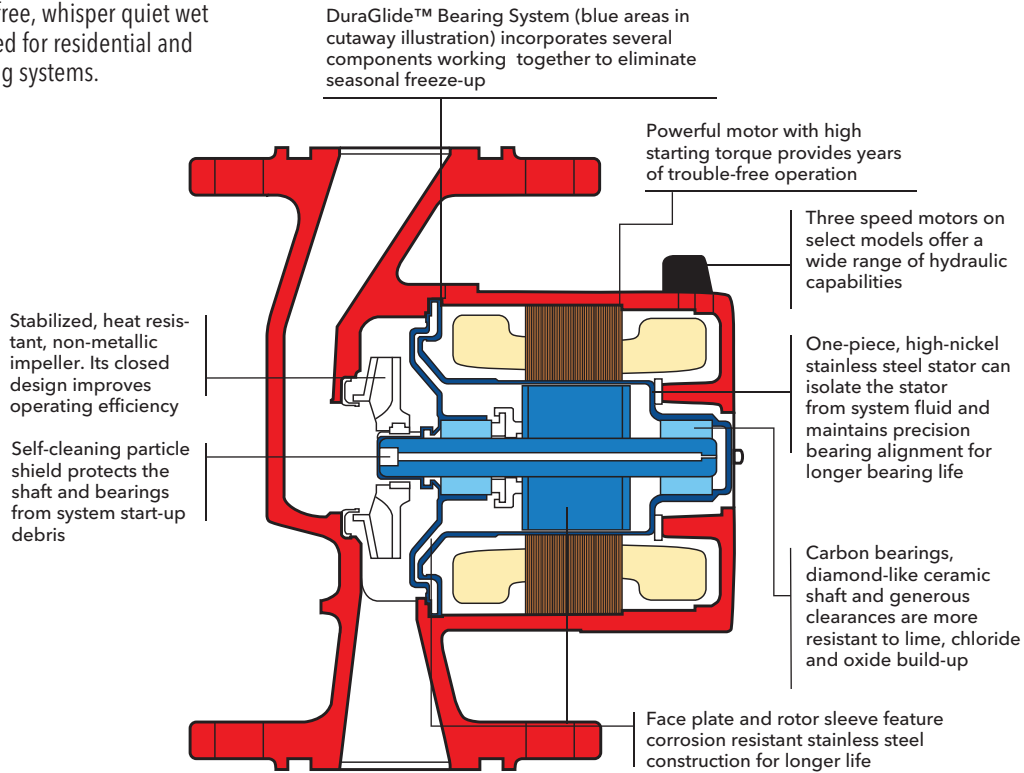

Single Speed NRF Circulator Performance Curves

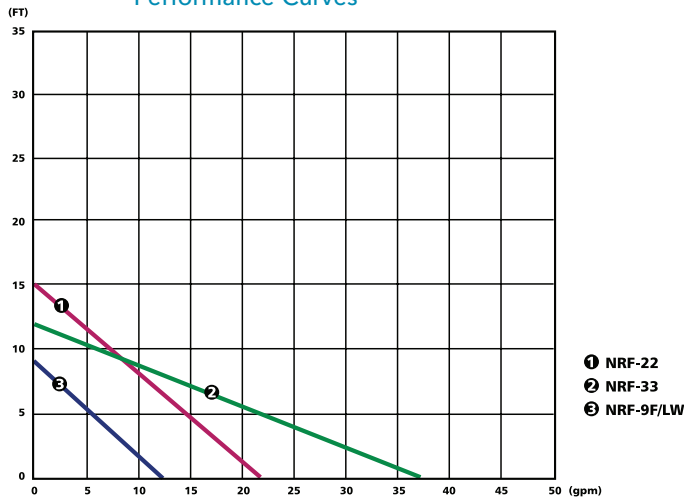

Three-Speed NRF Circulator Performance Curves

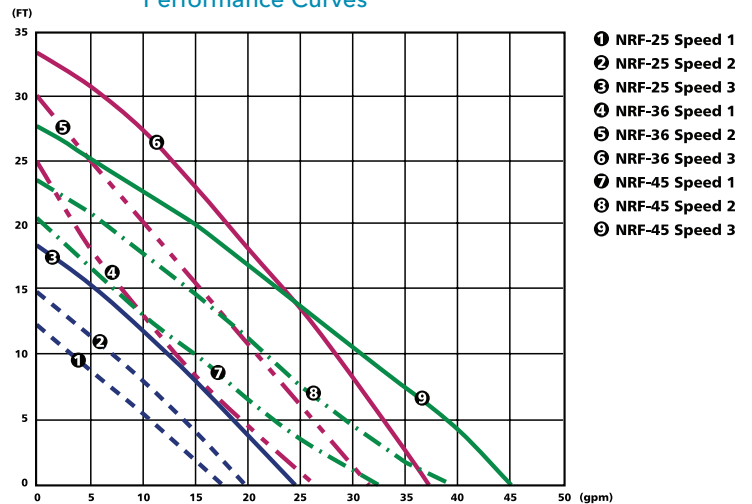

Single Speed NRF Circulators



NRF-9



NRF-22



NRF-33

CIRCULATORS Bell & Gossett Cast Iron Wet Rotor Circulators / NRF

Description

A residential or light commercial, maintenance free, axial flanged, in-line, cast iron, wet rotor circulation pump for hydronic heating systems. UL and cUL Listed.

Operating Data

Maximum working pressure 150 PSI (10 bar)
 Maximum operating temperature
 NRF-22 & NRF-9F/LW 240°F (115°C)
 NRF-33, NRF-36 & NRF-45 225°F (107°C)

Construction Materials

Pump Body Cast Iron
 Impeller Noryl
 Shaft Ceramic
 Bearings Double-Sintered Carbon

Warranty

Bell & Gossett offers a warranty of three years from date of manufacture or 18 months from date of installation (which ever comes first) against failure as a result of defects in materials and workmanship.

Specifications

Model Number	Single Speed	Three Speed	Part Number	Flange Sizes Inches - NPT	Dimensions Inches (mm)			Standard 60 Cycle Motor Characteristics*					Shipping Weight lbs. (Kg)
					A	B	C	Watts	∅	Volts	F.L. Amps	RPM	
NRF-9F/LW	●		103267	3/4, 1, 1 1/4, 1 1/2	6 3/8 (162)	6 3/16 (157)	5 1/8 (130)	41	1	115	0.40	2800	9.3 (4.2)
NRF-22	●		103251		6 3/8 (162)	6 3/16 (157)	5 1/8 (130)	92			0.80	2940	9.3 (4.2)
NRF-25		●	103417		6 3/8 (162)	6 3/16 (157)	5 1/8 (130)	125			1.20	2950	10.4 (4.7)
NRF-33	●		103350		6 3/8 (162)	5 9/16 (141)	4 7/8 (124)	125			1.10	2950	10.4 (4.7)
NRF-36		●	103400		6 3/8 (162)	6 7/8 (175)	5 3/4 (146)	270			2.30	3300	13.1 (6.0)
NRF-45		●	103404	1, 1 1/4, 1 1/2	8 1/2 (216)	7 3/8 (187)	5 3/4 (146)	270		2.30	3300	14.5 (6.6)	

NRF-9F/LW, NRF-22, NRF-25 and NRF-33 are impedance protected.
 NRF-36 and NRF-45 are thermally protected.
 Dimensions are approximate and subject to change. Contact factory for certified dimensions.

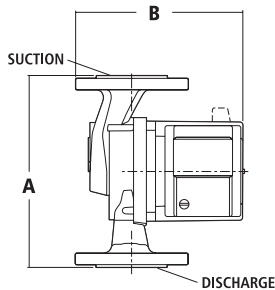

Our Pump Controllers



NRF-VS Pump Control is a versatile variable speed control for use in hydronic heating and cooling applications. Water temperature is controlled by regulating the speed of the pump which injects water from a different temperature water loop into a controlled loop.

The ZoneTrol II AZ-1A is a single zone pump relay that turns the pump and boiler on when the thermostat calls for heat. The AZ-1A is ideal when adding a zone to an existing system and can be daisy-chained together to control multiple zones.

Three-Speed NRF Circulators



NRF-25



NRF-36



NRF-45



CIRCULATORS Lead-Free Wet Rotor Circulators for Potable Water / NBF & SSF

Description

A residential or light commercial, maintenance-free, in-line, lead-free† bronze, wet rotor circulator for potable water systems and other applications. Flanged, union or sweat models available. UL, cUL and CSA listed

Operating Data

Maximum working pressure 50 PSI (10 bar)
 Maximum operating temperature
 NBF-25, NBF-33, NBF-36, NBF-45 225°F (107°C)
 All Others 230°F (110°C)
 Shaft Ceramic
 Bearings Double-Sintered Carbon

Materials of Construction

Pump Body NBF 100% Lead-Free† Bronze
 SSF Stainless Steel
 Impeller Noryl
 Shaft Ceramic
 Bearings Double-Sintered Carbon

Warranty

Bell & Gossett offers a warranty of three years from date of manufacture or 18 months from date of installation (which ever comes first) against failure as a result of defects in materials and workmanship.



SSF-9



NBF-9

Single Speed-NBF/SSF 60 HZ Performance Curve

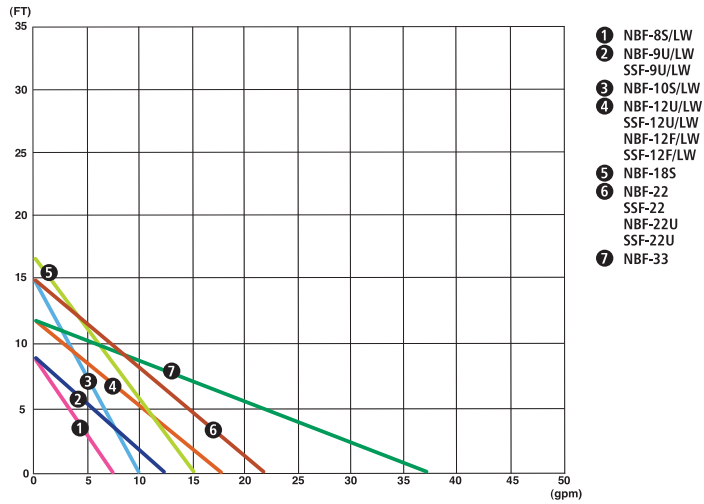

Three Speed-NBF 60 HZ Performance Curve

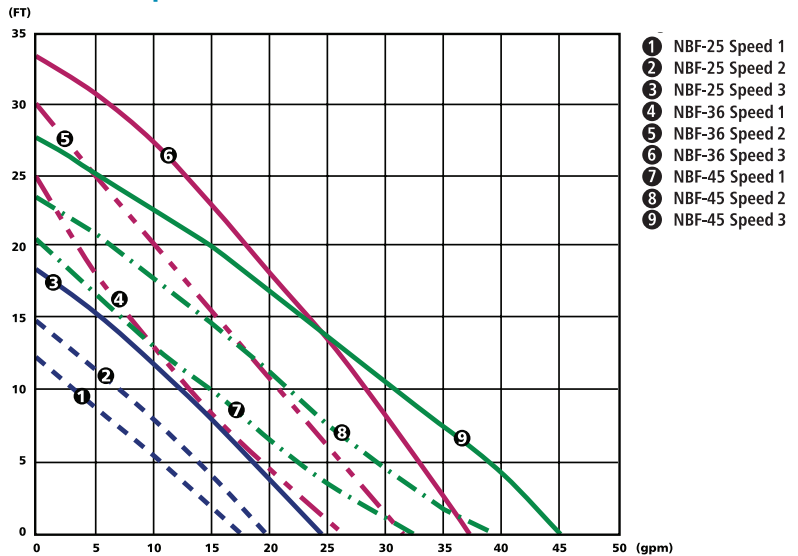

Cross Reference

BELL & GOSSETT	GRUNDOS‡	TACO♦
NBF-8S/LW	UM 15-10B5	003B
NBF-9U/LW	UP 15-18SU	006B
NBF-10S/LW	UP 15-18B5	006B
NBF-12U/LW	UP 15-42SU	005B
NBF-12F/LW	UP 15-42SF	005B
NBF-18S	UP 15-42B5	-
NBF-22U	UP 25-64SU	007B
NBF-22	UP 25-64SF	007B
SSF-22	UP25-64SF	007B
NBF-25	UPS15-58	00R-MS
NBF-33	-	0010B
NBF-36	UP26-96BF	0011B
	UP26-99BF	0013B
	UP26-64SF	0014B
NBF-45	UP43-75BF	-

‡ Grundfos is a registered trademark of Grundfos Pumps Corp.

♦ Taco is a registered trademark of Taco, Inc.

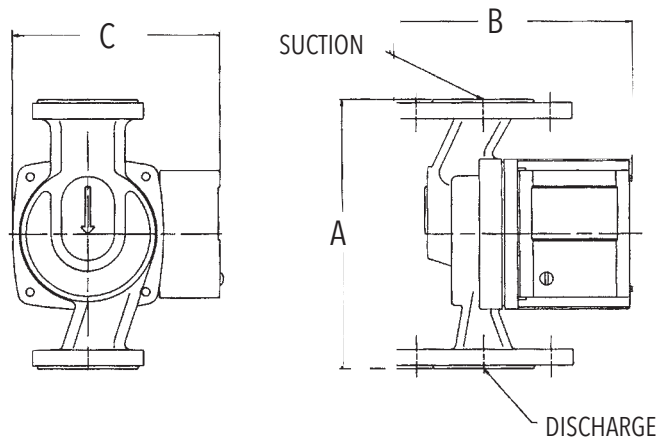

CIRCULATORS Lead-Free Wet Rotor Circulators for Potable Water / NBF & SSF – continued

Specifications

Model Number	Part Number	Connections	Dimensions Inches (mm)			Standard 60 Cycle Motor Characteristics*					Shipping Weight lbs. (Kg)
			A	B	C	Watts	Ø	Volts	F.L. Amps	RPM	
NBF-8S/LW	103257(LF)	1/2" Sweat	5 (127)	5 7/32 (132)	4 7/8 (124)	39	1	115	0.39	2800	9.0 (4.1)
NBF-9U/LW	103258(LF)	Union**	6 1/8 (156)	5 1/16 (129)	4 7/8 (124)	41			0.40		9.3 (4.2)
NBF-10S/LW	103259(LF)	1/2" Sweat	5 (127)	5 7/32 (132)	4 7/8 (124)	55			0.46		9.0 (4.1)
NBF-12F/LW	103260(LF)	Flange 3/4, 1, 1 1/4, 1 1/2	6 3/8 (162)	5 9/16 (141)	4 7/8 (124)	55			0.48		9.5 (4.3)
NBF-12U/LW	103261(LF)	Union**	6 1/8 (156)	5 1/16 (129)	4 7/8 (124)	55			0.48	9.3 (4.2)	
NBF-18S	103316(LF)	1/2" Sweat	5 (127)	5 7/32 (132)	4 7/8 (124)	90			0.74	3000	9.0 (4.1)
NBF-22	103252(LF)	Flange 3/4, 1, 1 1/4, 1 1/2	6 3/8 (162)	5 9/16 (141)	4 7/8 (124)	92			0.80	2940	9.5 (4.3)
NBF-22U	103255(LF)	Union**	6 1/8 (156)	5 1/16 (129)	4 7/8 (124)	92			0.80		9.3 (4.2)
NBF-25	103418(LF)	Flange 3/4, 1, 1 1/4, 1 1/2	6 3/8 (162)	6 3/16 (157)	5 1/8 (130)	125			1.10	2950	10.4 (4.7)
NBF-33	103351(LF)	Flange 3/4, 1, 1 1/4, 1 1/2	6 3/8 (162)	6 3/16 (157)	5 1/8 (130)	125			1.10		10.4 (4.7)
NBF-36	103401(LF)	Flange 3/4, 1, 1 1/4, 1 1/2	6 3/8 (162)	6 7/8 (175)	5 3/4 (146)	270			2.30	3300	13.1 (6.0)
NBF-45	103405(LF)	Flange 1, 1 1/4, 1 1/2	8 1/2 (216)	7 3/8 (187)	5 3/4 (147)	270			2.30		14.5 (6.6)
SSF-9U/LW	103360LF	Union**	6 1/8 (156)	5 1/16 (129)	4 7/8 (124)	41			0.40	2800	9.3 (4.2)
SSF-12F/LW	103358LF	Flange 3/4, 1, 1 1/4, 1 1/2	6 3/8 (162)	5 9/16 (141)	4 7/8 (124)	55			0.48		9.5 (4.3)
SSF-12U/LW	103361LF	Union**	6 1/8 (156)	5 1/16 (129)	4 7/8 (124)	55			0.48	9.3 (4.2)	
SSF-22	103357LF	Flange 3/4, 1, 1 1/4, 1 1/2	6 3/8 (162)	5 9/16 (141)	4 7/8 (124)	92			0.80	2940	9.5 (4.3)
SSF-22U	103362LF	Union**	6 1/8 (156)	5 1/16 (129)	4 7/8 (124)	92			0.80		9.3 (4.2)

* Impedance protected

** Union Connections are available in 3/4" NPT, 1/2" sweat & 3/4" sweat.

CIRCULATORS Series LR™ Maintenance-Free Circulators

Operating Data

Maximum working pressure 150 PSI (10 bar)

Maximum operating temperature 225°F (107°C)

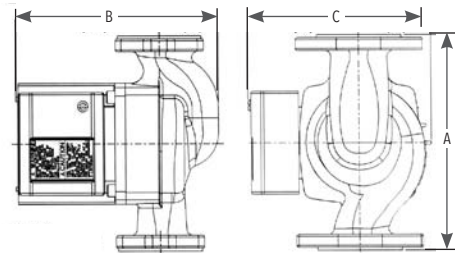
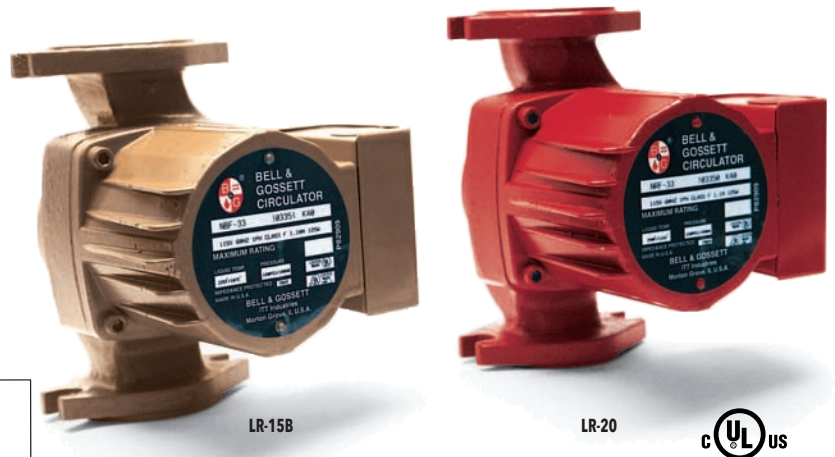
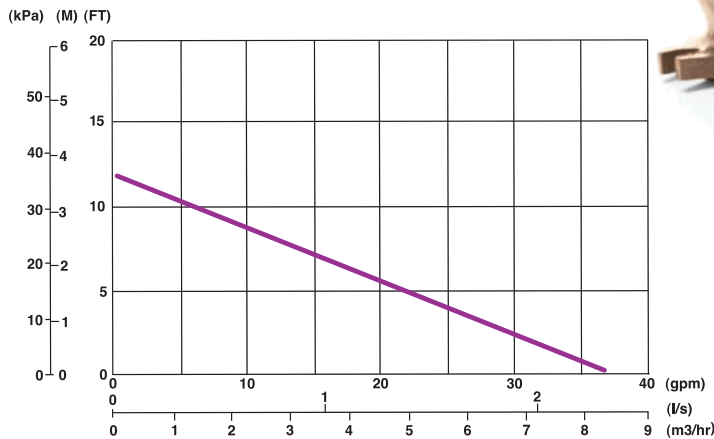

Specifications

Model Number	Part Number	Pump Body Material	Flange Sizes Inches-NPT	Dimensions Inches (mm)			Standard 60Hz Motor Characteristics*					Approx. Shpg. Wt. lbs (Kg)
				A	B	C	Watts	Ø	Volts	F.L. Amps	RPM	
LR-20WR	106507	Cast Iron	3/4, 1, 1-1/4, 1-1/2	6-3/8 (162)	6 (152)	5-3/8 (137)	125	1	115	1.10	2950	10.4 (4.7)
LR-15BWR	106514LF	Bronze	3/4, 1, 1-1/4, 1-1/2									

CIRCULATORS Maintenance-Free Circulators

SERIES PL™ a superior alternative to large wet rotor pumps



PL-30, 36, 45, 50, 55



PL-75, 130

Operating Data

Maximum working pressure 150 PSI (10.3 bar)

Maximum operating temperature 225°F (107°C)

Specifications

Cast Iron		Lead Free		Flange Size Inches - NPT	Motor Characteristics*				Dimensions in inches (mm) @ 60 Hz (Open Drip-Proof)					Approx. Shipp. Wt. lbs. (Kg)
Model No.	Part No.	Model No.	Part No.		HP	ø	Voltage	RPM	A	B	C	D	E	
PL-30	1BL012	PL-30B	1BL013LF	3/4, 1, 1 1/4, 1 1/2	1/12	1	115	2650	8 5/8 (219)	6 3/8 (162)	7 1/8 (181)	4 3/16 (106)	4 3/8 (111)	11.6 (5.3)
PL-36	1BL001	PL-36B	1BL003LF	3/4, 1, 1 1/4, 1 1/2	1/6			3300	8 5/8 (219)	6 3/8 (162)	7 1/8 (181)	4 3/16 (106)	4 3/8 (111)	13.1 (6.0)
PL-45	1BL002	PL-45B	1BL004LF	1, 1 1/4, 1 1/2	1/6			3300	9 1/8 (232)	8 1/2 (216)	7 1/4 (184)	4 5/8 (117)	4 1/2 (114)	14.5 (6.6)
PL-50	1BL016	PL-50B	1BL017LF	1, 1 1/4, 1 1/2	1/6			3300	9 1/8 (232)	8 1/2 (216)	7 1/4 (184)	4 5/8 (117)	4 1/2 (114)	14.5 (6.6)
PL-55	1BL032	PL-55B	1BL068LF	3/4, 1, 1 1/4, 1 1/2	2/5			3250	9 9/16 (243)	6 3/8 (162)	7 15/16 (202)	4 3/16 (106)	4 3/4 (121)	13.1 (6.0)
PL-75	1BL034	PL-75B	1BL035LF	2	1/6			3400	9 15/16 (252)	8 1/2 (216)	7 3/8 (187)	5 3/16 (132)	4 5/8 (117)	18.5 (8.4)
PL-130/ 2"	1BL063	PL-130B/ 2"	1BL065LF	2	2/5			3200	10 3/4 (273)	8 1/2 (216)	8 1/4 (210)	5 3/16 (132)	5 1/8 (130)	22 (10)
PL-130/ 3"	1BL070	PL-130B/ 3"	1BL072LF	2 1/2 & 3	2/5			3200	10 3/4 (273)	8 1/2 (216)	8 1/4 (210)	6 (152)	5 1/8 (130)	27 (12.2)

* 230/60/1 motors available upon request. Models PL-75 and PL-130 have four bolt hole flange connection, all others have two bolt hole flange connectors. Dimensions are approximate and subject to changes. Contact factory for certified dimensions.

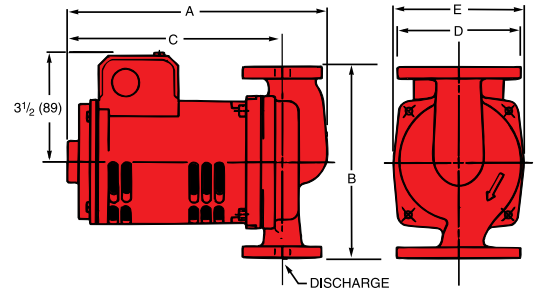
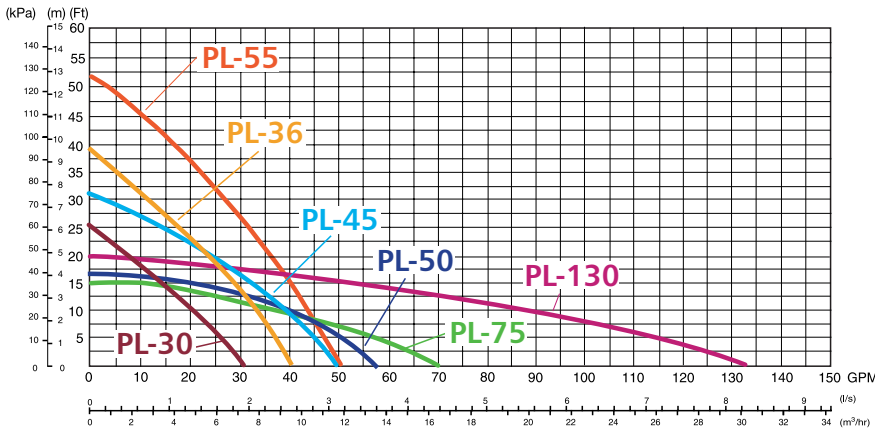

- 1 B&G's powerful, dry-motor design delivers exceptional performance. . . . 25% more efficient than competition.
- 2 Precision-machined and balanced alloy steel rotor for superior performance.
- 3 Quick-connect wire nut leads and dual knock-outs make for fast, sure hook-ups.
- 4 Solid "Stiff-Shaft" design is constructed of high-strength alloy steel impervious to cracking caused by thermal stresses.

- 5 XL-11™ Precision-Crafted Bearing System... is permanently oil lubricated... completely maintenance free... precisely positioned for long-life and isolated for quiet operation.
- 6 Advanced close-coupled design increases pump life and efficiency, assures dependable seasonal start-ups and can easily handle difficult water conditions.
- 7 Tough, durable seal system features a carbon/silicon carbide seal on a stainless steel shaft sleeve for long life and rugged operation.

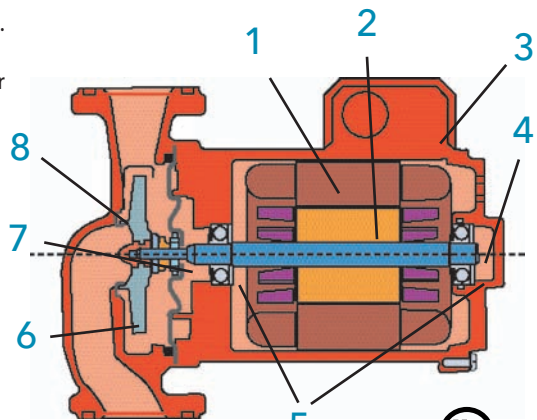

- 8 Double sided I-Seal™ design for optimum efficiency.



CIRCULATORS Oil Lubricated Circulators Three-Piece

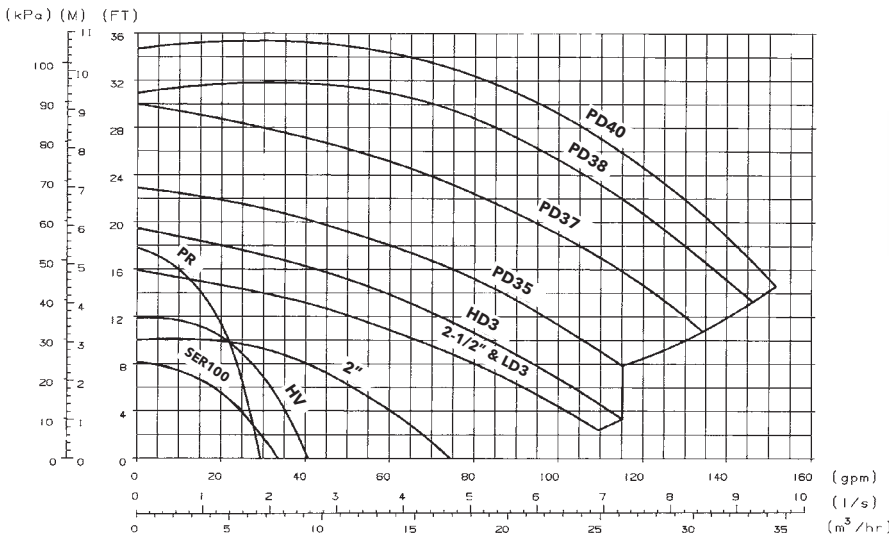

Maximum working pressure 125 PSI (8.6 bar)
 Maximum operating temperature
 Standard Seal 225°F (107°C) continuous
 Special Seals 250°F (121°C) continuous

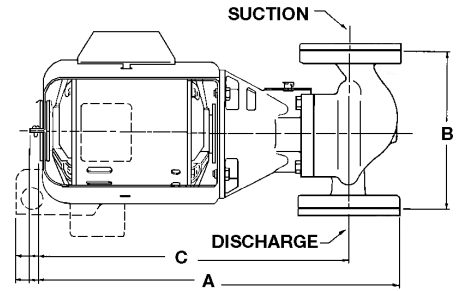

Specifications

Model No.	Cast Iron		Bronze		Flange Size Inches (NPT)	Motor Characteristics* @ 60 Hz			Dimensions in Inches (mm) (Open Drip-Proof)			Approximate Shpg. Wt. lbs. (Kg)	
	Model No.	Part No.	Model No.	Part No.		HP	Ø	Voltage	A	B	C	Cast Iron	Bronze
Series 100	100NFI	106189	100 AB	106192LF	3/4, 1	1/12	115	230	14-7/8 (378)	6-3/8 (162)	12-3/4 (324)	20 (9)	21 (10)
	100BI	106190	100 BNFI	106197LF	1-1/4, 1-1/2				15-1/4 (387)	8-1/2 (216)	12-3/4 (324)	30 (14)	32 (15)
Series PR	PR	102206	PR AB	102208LF	3/4, 1	1/6	115	230	15-3/8 (391)	8-1/2 (216)	13 (330)	28 (13)	30 (14)
	PR BI	102207		102231LF	1-1/4, 1-1/2				16-5/8 (422)	8-1/2 (216)	14 (356)	36 (16)	39 (18)
Series HV	HV NFI	102210	HV AB	102231LF	1, 1-1/4, 1-1/2	1/6	115	230	17-1/4 (438)	10 (254)	14 (356)	54 (24)	58 (26)
	HV BI	102230	HV BNFI	102213LF	2				17-1/4 (438)	10 (254)	14 (356)	53 (24)	57 (26)
2"	2 NFI	102214	2AB	102233LF	2	1/6	115	230	20-1/4 (514)	12 (305)	16-7/8 (429)	75 (34)	80 (36)
	2 BI	102232	2 BNFI	102217LF	3				20-1/4 (514)	12 (305)	16-7/8 (429)	75 (34)	80 (36)
2-1/2"	2-1/2 BI	102218	2-1/2 AB	102220LF	2-1/2	1/4	115	230	20-1/4 (514)	12 (305)	16-7/8 (429)	75 (34)	80 (36)
	2-1/2 NFI	102219		102222LF	3				24 (610)	14-1/2 (368)	20-1/4 (514)	125 (57)	135 (61)
LD3	LD3 BI	102223	LD3 AB	102224LF	3	1/4	115	230	21-7/8 (556)	14-1/2 (368)	18-1/8 (460)	127 (58)	137 (62)
	LD3	102222	LD3 AB	102224LF	3				21-7/8 (556)	14-1/2 (368)	18-1/8 (460)	127 (58)	137 (62)
HD3	HD3	102226	HD3 AB	102228LF	3	1/3	115	230	21-7/8 (556)	14-1/2 (368)	18-1/8 (460)	127 (58)	137 (62)
	HD3 BI	102227		102228LF	3				21-7/8 (556)	14-1/2 (368)	18-1/8 (460)	127 (58)	137 (62)
PD-35S	PD35S	105089	PDB35S	105092LF	3	1/2	1	115/230	20-1/4 (514)	12 (305)	16-7/8 (429)	75 (34)	80 (36)
	PD35S BI	105090		105092LF	3				20-1/4 (514)	12 (305)	16-7/8 (429)	75 (34)	80 (36)
PD-35T	PD35T	105093	PDB35T	105096LF	3	1/2	3	208-230/460	20-1/4 (514)	12 (305)	16-7/8 (429)	75 (34)	80 (36)
	PD35T BI	105094		105096LF	3				20-1/4 (514)	12 (305)	16-7/8 (429)	75 (34)	80 (36)
PD-37S	PD37S	105097	PDB37S	105100LF	3	3/4	1	115/230	20-1/4 (514)	12 (305)	16-7/8 (429)	75 (34)	80 (36)
	PD37S BI	105098		105100LF	3				20-1/4 (514)	12 (305)	16-7/8 (429)	75 (34)	80 (36)
PD-37T	PD37T	105101	PDB37T	105104LF	3	3/4	3	208-230/460	20-1/4 (514)	12 (305)	16-7/8 (429)	75 (34)	80 (36)
	PD37T BI	105102		105104LF	3				20-1/4 (514)	12 (305)	16-7/8 (429)	75 (34)	80 (36)
PD-38S	PD38S	105121	PDB38S	105123LF	3	1	1	115/230	22-3/4 (578)	14-1/2 (368)	19 (483)	128 (58)	138 (63)
	PD38S BI	105122		105123LF	3				22-3/4 (578)	14-1/2 (368)	19 (483)	128 (58)	138 (63)
PD-38T	PD38T	105133	PDB38T	105135LF	3	1	3	208-230/460	24 (610)	14-1/2 (368)	20-1/4 (514)	125 (57)	135 (61)
	PD38T BI	105134		105135LF	3				24 (610)	14-1/2 (368)	20-1/4 (514)	125 (57)	135 (61)
PD-40S	PD40S	105151	PDB40S	105153LF	3	1-1/2	1	115/230	24-3/4 (629)	14-1/2 (368)	21 (533)	130 (59)	140 (64)
	PD40S BI	105152		105153LF	3				24-3/4 (629)	14-1/2 (368)	21 (533)	130 (59)	140 (64)
PD-40T	PD40T	105137	PDB40T	105139LF	3	1-1/2	3	208-230/460	21-7/8 (556)	14-1/2 (368)	18-1/8 (460)	127 (58)	137 (62)
	PD40T BI	105138		105139LF	3				21-7/8 (556)	14-1/2 (368)	18-1/8 (460)	127 (58)	137 (62)

PD-38 and PD-40 are ball bearing, maintenance-free design.

*Special motors available upon request. Dimensions are approximate and subject to changes.

Contact factory for certified dimension.

1 B&G Motor – The heart of the Booster. The finest circulator motor available. Sleeve bearing, oil lubricated with replaceable resilient motor mounts. B&G motors are designed and manufactured specifically for the B&G boosters.

2 Noise dampening coupler. B&G's own flexible spring design adds to quiet operation. Do not accept a substitute.

3 Long bronze sleeve bearings maintain exact shaft alignment. Provides for constant circulation of oil over bearing surfaces.

4 Precision ground pump shaft is oversized to provide large bearing surfaces. Hardened integral thrust collar minimizes end-thrust to ensure long seal and bearing life.

5 The B&G mechanical seal is designed to withstand the wide range of water temperatures, pressures, additives and dissolved solids common in hydronic systems.

6 Centrifugal impeller prevents accumulation of air at seal faces to assure long life. Close impeller/body tolerances minimize water slippage and maximize efficiency.

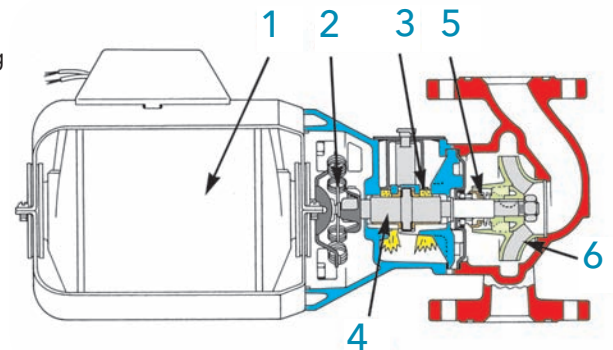

CIRCULATORS Series 60 In-Lined Mounted Centrifugal Pump

- Maintenance-Free Pump and Motor Design
- Improved Hydraulic Performance
- Smooth, Quiet Operation
- Parts Interchangeability
- Quality Product

Designed for a variety of applications.

- Hydronic heating & cooling systems
- Domestic water
- Fluid transfer

The advantages you want. The pump you need.

- Compact design
- Easy installation
- Wide range of standard sizes
- Backed by B&G three-year warranty*

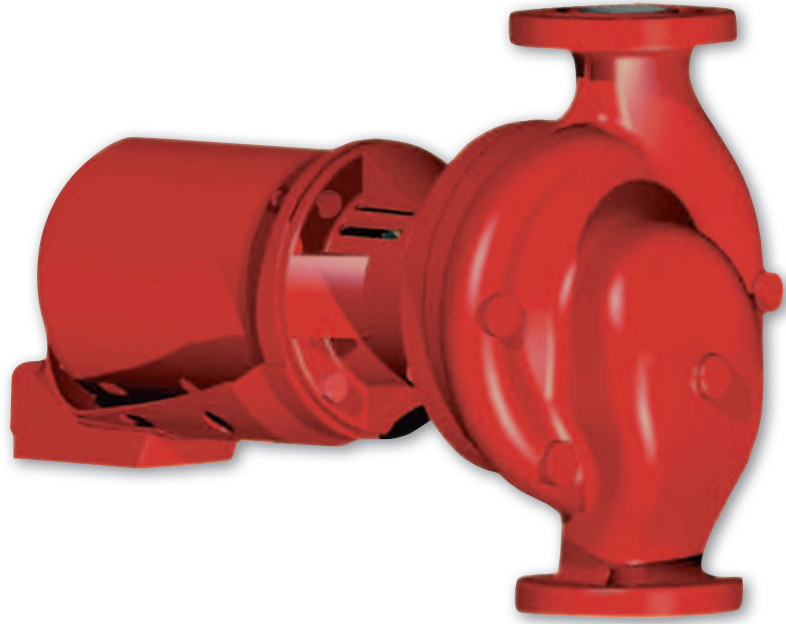

DESCRIPTION	BRONZE-FITTED PUMP	ALL-BRONZE PUMP
Volute	Cast Iron ASTM #A159	Cast Bronze ASTM #B584
Face Plate	304 Stainless Steel	304 Stainless Steel
Impeller	Cast Bronze ASTM #B584	Cast Bronze ASTM #B584
Impeller Key	Carbon Steel	Carbon Steel
Impeller Lock Washer	Carbon Steel	Brass
Impeller Lock Nut	Plated Steel	Brass
Pump Shaft	Steel SAE 1144	Steel SAE 1144
Shaft Sleeve	Copper Alloy 110	Copper Alloy 110
Seal Assembly		
A. Housing	Brass ASTM #B36	Brass ASTM #B36
B. Bellow	Buna "N" (EPT Optional)	Buna "N" (EPT Optional)
C. Rotating Ring	Carbon	Carbon
D. Spring	#304 Stainless Steel	#304 Stainless Steel
E. Seat	Ceramic	Ceramic
F. Seat Gasket	Buna "N" (EPT Optional)	Buna "N" (EPT Optional)
Volute Gasket	Cellulose Fiber	Cellulose Fiber
Cover Plate (7" Impeller size only)	Cast Iron ASTM #A159	Cast Bronze ASTM #B584
Companion Flanges	1", 1-1/4" & 1-1/2" Formed Steel 2" Cast Iron ASTM #A159	1" & 1-1/4" Formed Brass 1-1/2" & 2" Cast Brass ASTM #B584

MECHANICAL SEAL SPECIFICATIONS:

Buna - pH Limitations 7-9; Temperature Range -20 to +225°F
 EPT - pH Limitations 7-11; Temperature Range -20 to +250°F

CIRCULATORS Series 60 In-Lined Mounted Centrifugal Pump

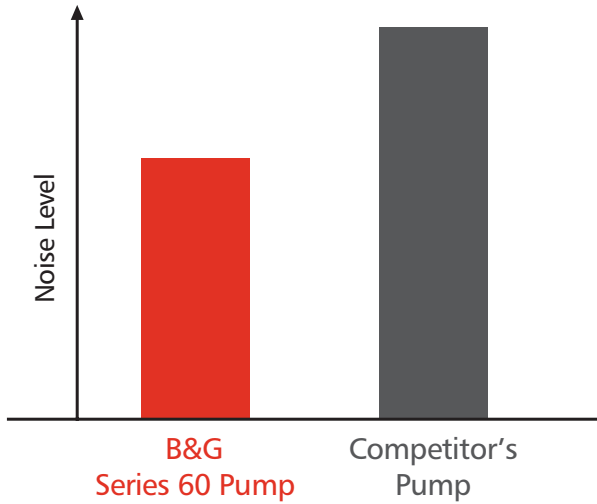

Quiet operation

The XL-11® Precision-Crafted Bearing System, advanced fluid passage design and B&G permanently lubricated motor come together to deliver smooth, quiet, maintenance-free performance.

Internally self-flushing seal

Bell & Gossett's open-seal chamber design provides superior flow circulation around the seal faces, resulting in reduced heat buildup, increased particle removal and superior seal-face flushing. It all adds up to long, trouble-free seal performance.

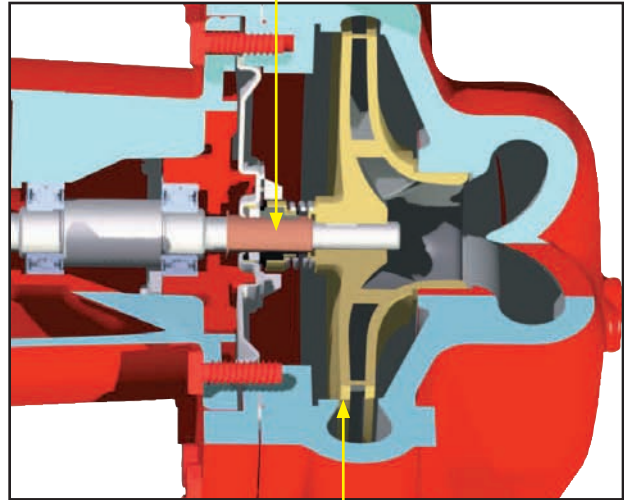

Impeller

State-of-the-art hydraulically balanced impellers and resilient-mounted motors provide smooth, quiet operation.

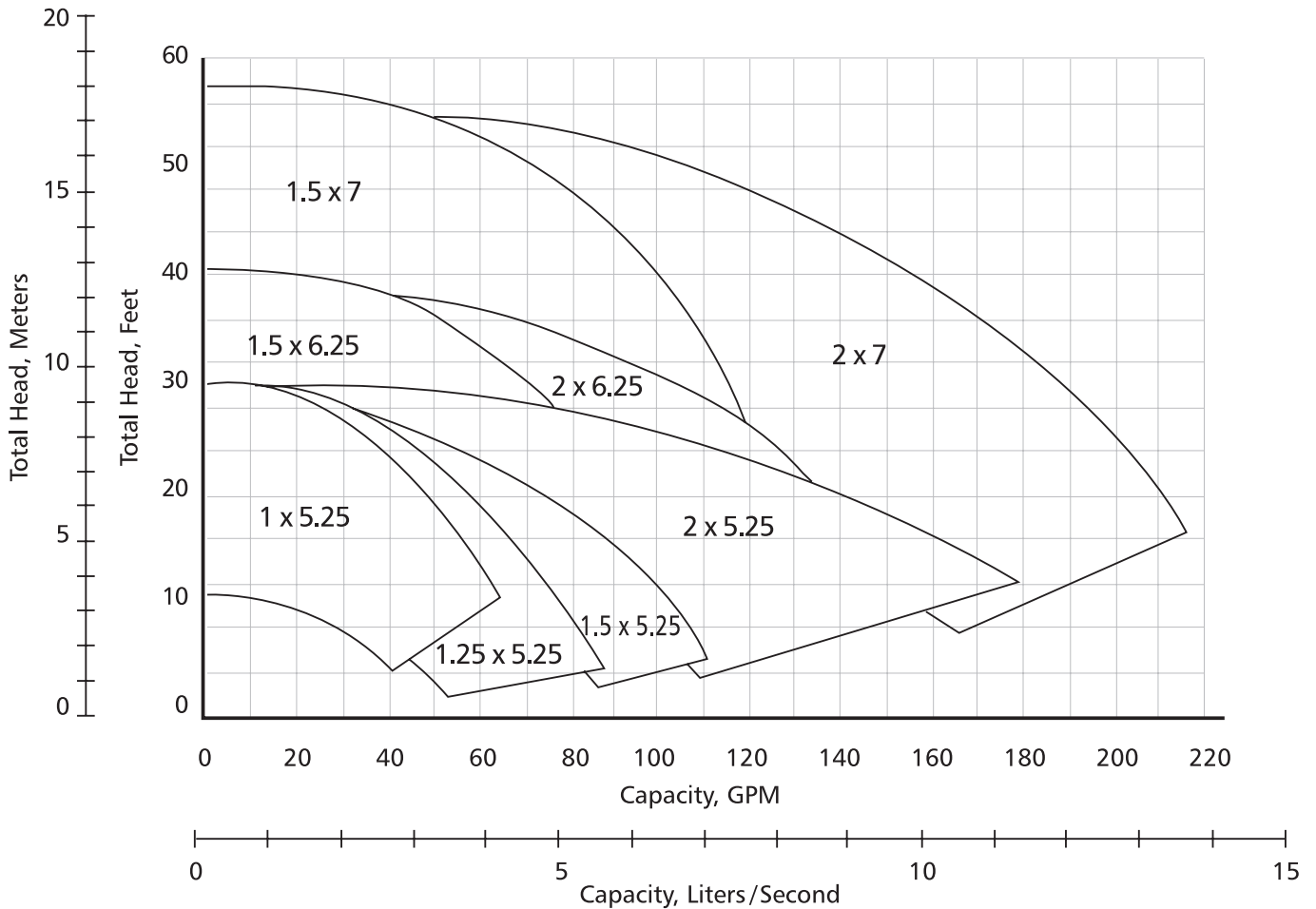

FLANGES Check-Trol™ Isolation Flow Control Flange

Description

The Check-Trol flange is a combination isolation valve, flow control valve, and companion flange for circulators. The ball valve allows the circulator to be removed from the system without draining the system. The internal spring check prevents gravity circulation. Free floating companion flange makes pump installation a snap.

Operating Data

Maximum working pressure 150 PSI (10 bar)
 Maximum operating temperature 200°F (93°C)

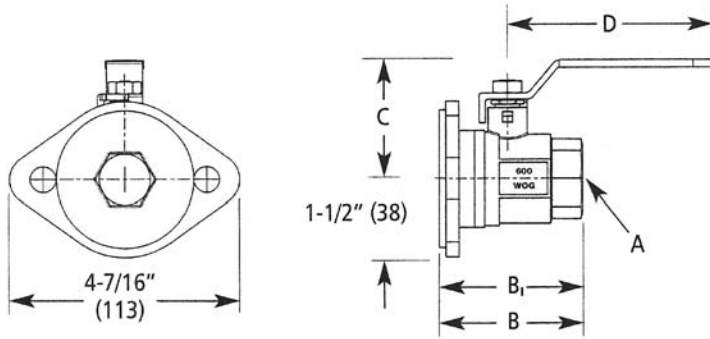
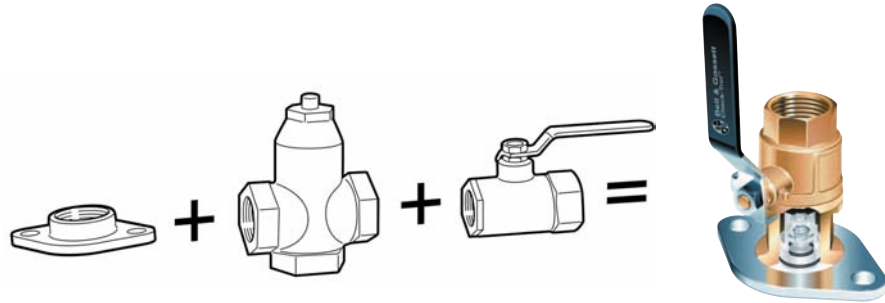

Specifications

Model No.	Size Inches	Model	Use with Following Circulators	Dimensions -Inches (MM)					Approx. Shpg. Wt. Lbs. (Kg)
				A	B	B ₁ **	C	D	
101231LF	3/4" NPT x Flange	CTF-3/4	NRF/NBF/SSF Wet Rotors	3/4" NPT	3-7/64" (79.0)	2-27/64" (61.5)	2" (50.5)	4-23/32" (120.0)	3.4 (1.5)
101232LF	1" NPT x Flange	CTF-1	Series PL-30, PL-36, PL-55	1" NPT	3-15/16" (100.0)	2-57/64" (73.3)	2-5/32" (54.7)	4-23/32" (120.0)	4.4 (2.0)
101233LF	1-1/4" NPT x Flange	CTF-1-1/4	Series 100, PR, and LR	1-1/4" NPT	4-25/32" (121.4)	3-19/64" (84.0)	3" (75.9)	6-7/32" (158.0)	6.3 (2.8)
101245LF	1-1/2" NPT x Flange	CTF-1-1/2	NRF/NBF/SSF, etc.	1-1/2" NPT	4-27/32" (122.9)	3-23/64" (85.5)	3" (75.9)	6-7/32" (158.0)	6.6 (3.0)
101236LF	3/4" SWT x Flange	CTF-3/4	NRF/NBF/SSF Wet Rotors	3/4" SWT	3-21/64" (84.5)	2-41/64" (67.0)	2" (50.5)	4-23/32" (120.0)	3.4 (1.5)
101237LF	1" SWT x Flange	CTF-1	Series PL-30, PL-36, PL-55	1" SWT	4-1/64" (102.0)	3" (75.3)	2-5/32" (54.7)	4-23/32" (120.0)	4.2 (1.9)
101238LF	1-1/4" SWT x Flange	CTF-1-1/4	Series 100, PR, and LR	1-1/4" SWT	4-55/64" (123.4)	3-25/64" (86.0)	3" (75.9)	6-7/32" (158.0)	5.9 (2.7)
101247LF	1-1/2" SWT x Flange	CTF-1-1/2	PL-45, PL-50 and Series HV	1-1/2" SWT	5-1/64" (127.4)	3-35/64" (90.0)	3" (75.9)	6-7/32" (158.0)	6.5 (3.0)

• Not for use with NRF/NBF-45, HV flanges required.

Dimensions and weights are approximate and subject to change. Contact factory for certified dimensions. Check-Trol flange is sold with an isolation flange as a pair.

** B₁ Dimension is overall length of isolation flange. The part numbers and shipping weights are for one Check-Trol flange and one isolation flange, capscrews and nuts.

Isolation Flanges

Description

The isolation flange is a combination of an isolation ball valve and a companion flange for circulators. The isolation flange allows easy service or replacement of the circulator without the need to drain the system. The isolation flange fits the Bell & Gossett NRF/NBF/SSF wet rotors, Series PL, Series 100, HV, PR and LR circulators.

Operating Data

Maximum working pressure 150 PSI (10 bar)
 Maximum operating temperature 250°F (121°C)

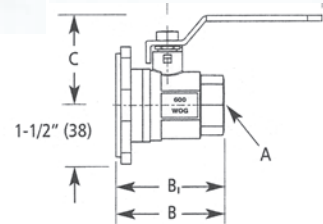
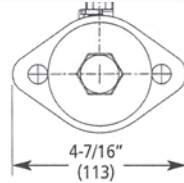

Specifications

Model No.	Size Inches	Use with Following Circulators	Dimensions - Inches (mm)				Approx. Shpg. Wt. lbs. (Kg)	
			A	B	C	D		
101221LF	3/4" NPTF IF	NRF/NBF/SSF wet rotors Series PL-30, PL-36, PL-55 Series 100, PR and LR	3/4" NPT	2-27/64" (61.5)	2" (50.5)	4-47/64" (120)	3.2 (1.5)	
101222LF	1" NPTF IF		1" NPT	2-57/64" (73.3)	2-5/32" (54.7)	4-47/64" (120)	4.1 (1.9)	
101223LF	1-1/4" NPTF IF		1-1/4" NPT	3-19/64" (84)	3" (75.9)	6-7/32" (158)	5.8 (26)	
101241LF	1-1/2" NPTF IF		1-1/2" NPT	3-23/64" (85.5)	3" (75.9)	6-7/32" (158)	6.1 (28)	
101226LF	3/4" SWT IF		Does not include NRF/N BF-45	3/4" SWT	2-41/64" (67)	2" (50.5)	4-23/32" (120)	3.2 (1.5)
101227LF	1" SWT IF			1" SWT	3" (75.3)	2-5/32" (54.7)	4-23/32" (120)	3.9 (1.8)
101228LF	1-1/4" SWT IF			1-1/4" SWT	3-25/64" (86)	3" (75.9)	6-7/32" (158)	5.4 (25)
101243LF	1-1/2" SWT IF	1-1/2" SWT		3-35/64" (90)	3" (75.9)	6-7/32" (158)	6 (27)	

"IF" = "Isolation Flange"

Note: Dimensions and weights are approximate and subject to change. Contact factory for certified dimensions. The part numbers and shipping weights are for two isolation flanges, capscrews and nuts.

Companion Flanges

Flanges for Cast Iron Circulators

	Size (NPT)	Master Carton of 12 Part No.*	Set of 2 Part No.
Series 100, PR, NRF-22, NRF-9F/LW, NRF-33, NRF-36 PL-30, PL-36, PL-55	3/4"	101001	101201
	1"	101002	101202
	1-1/4"	101003	101203
	1-1/2"	101004	101204
Series HV, PL-45, PL-50, NRF-45	1"	101005	101205
	1-1/4"	101006	101206
	1-1/2"	101007	101207

	Size (NPT)	Set of 2 Part No.*
PL-75, PL-130/2"	2"	101215
PL-130/3"	2-1/2"	101219
	3"	101217

*Includes Fasteners

Flanges for Bronze Circulators

	Size (NPT)	Master Carton of 12 Part No.*	Set of 2 Part No.
Series 100B, PRAB, NBF-22, NBF-12F/LW, NBF-33, NBF-36, PL-30B, PL-36B	3/4"	101011LF	101208LF
	1"	101012LF	101209LF
	1-1/4"	101013LF	101210LF
	1-1/2"	101014LF	101211LF
Series HVB, PL-45B, PL-50B, NBF-45	1"	101015LF	101212LF
	1-1/4"	101015LF	101213LF
	1-1/2"	101017LF	101214LF

	Size (NPT)	Set of 2 Part No.*
PL-75B, PL-130B/2"	2"	101216
PL-130B/3"	2-1/2"	101220
	3"	101218

*Includes Fasteners

Union Connection for NBF Circulators

	Union Connection	Set of Two	
		Model No.	Part No.
NBF-22U, NBF-12U/LW NBF-9U/LW	1/2" sweat	UC-1/2S	113203LF
	3/4" sweat	UC-3/4S	113201LF
	3/4" NPT	UC-3/4 NPT	113202LF



Description

To increase the overall efficiency of a domestic hot water recirculating system and to reduce water wasted while waiting for hot water, the e³ Timer can be installed on all e³ pumps. The timer is easily installed by removing the motor end cap, plugging in the timer and setting the timer schedule without any wiring. The timer can be used in 3-different selections: ON, OFF and TIMER. The ON selection operates the pump continuously, the OFF selection turns the pump OFF and the TIMER selection (depicted by a clock on the timer) turns the pump on when programmed.

Operational Limits

Power Supply: Internally powered by the e³ circulating pump.
Minimum Switch Interval: 30 minutes.
Run Modes: ON (Continuous), OFF (Off at all times) and TIMER (run at programmed intervals)



Accessories for NBF Circulators



TC-1 Automatic Timer Kit (Part No. 113210)

To increase the overall efficiency of a hot water recirculation system, the TC-1 timer control kit can be installed for use on any B&G NBF circulator. The TC-1 timer control is programmable to turn the circulator ON and OFF automatically at preset times. This permits the user to have the pump circulate hot water only during those times when high usage can be expected throughout the day. Power supply minimum interval switch is 15 minutes. Run modes maximum switch current is 16 amps.



AQS-1/2 (Part No. 113223) and AQS-3/4 (Part No. 113224) Aquastat

Designed to thermostatically turn any B&G NBF circulator ON and OFF. The AQ-1/2 or AQ-3/4 will switch the pump OFF at 120°F (48.9°C) and ON at 100°F (37.8°C). The aquastats are available in separate models that will sense the temperature for either 1/2" or 3/4" copper pipe.

AQS-1/2" clips onto 1/2" copper pipe or 3/8" steel pipe
AQS-3/4" clips onto 3/4" copper pipe or 1/2" steel pipe

ACCESSORIES NRF-VS Variable Speed Control

The B&G NRF-VS Control is a versatile variable speed control designed for use in hydronic heating and cooling applications. This simple all-in-one control can be used as either a set point control or a signal follower. It is ideal for applications requiring a variable speed controller including primary-secondary injecton and bypass boiler injection. No need to stock different models for different applications. One control does it all!

One simple control has two options, with just a flip of a switch.

Follows analog signal 4-20mA or 2-10V

- Perfect for systems where a signal is provided by a Building Management System.

- Either 4-20mA or 2-10V. No need to install a resistor.

Setpoint control

- Dial in the desired setpoint temperature
- Heating or cooling option

Additional features

- External LEDs: Easy diagnostics
- Pump exercise: Avoids seasonal freeze up
- Linear or Logarithmic output mode to maximize flow relationship to output
- Response time can be adjusted to best fit the application.

The NRF-VS Control is available as a field mountable controller that can be installed onto a B&G wet rotor in the field. The snap-on design allows the NRF-VS to be quickly attached to a standard B&G wet rotor circulator.



Description

The NRF-VS is a variable speed control for use in hydronic heating and cooling applications. The temperature of the water is controlled by regulating the speed of the pump which injects water from a different temperature water loop (Primary loop) into a controlled loop (Secondary loop). As the speed of the pump increases, more water is sent into the Secondary loop, resulting in a secondary loop water temperature change. The NRF-VS can be used with an external analog signal (4-20mA or 2-10V) or with a sensor as a set point control.

Operating Data

Input Signal: External 4-20mA or 2-10V or factory supplied sensor

Maximum working pressure: 150 PSI

Maximum operating temperature: 240°F with iron body circulator, 230°F with brass and stainless steel body circulator

Electronic rating: 115V, 60 Hz, 1Ø

Suitable for use with B&G wet rotor pump with less than 1.1 amps pump nameplate reading.

Features

- 4-20mA or 2-10V external signal
- Setpoint control: Heating (70°F to 200°F) or cooling (30°F to 100°F) using factory supplied sensor.
- External LEDs for power and pump speed
- Linear or logarithmic output
- Normal or fast gain: response time to temperature changes
- Pump exercise (10 seconds after 3 days of no operation)
- Can be used with NRF-22, NRF-9, NRF-33, NBF-8S, NBF-9U, NBF-10S, NBF-12F, NBF-12U, NBF-18S, NBF-22, NBF-22U, NBF-33, SSF-9U, SSF-12F, SSF-12U, SSF-22, SSF-22U

Model No.	Part No.	Description	Power Input
NRF-VS	109410	Field mountable control with (1) sensor	115V/60 Hz/1 phase

Typical Applications

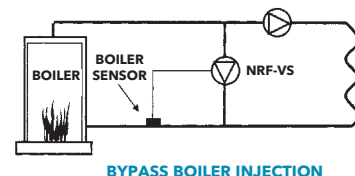
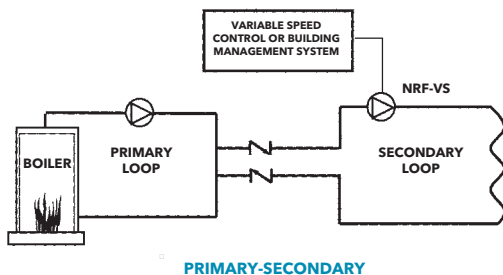
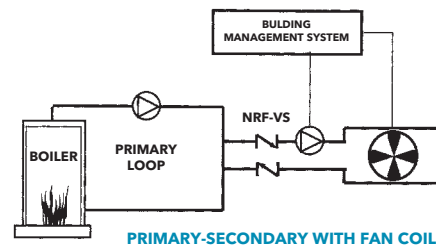
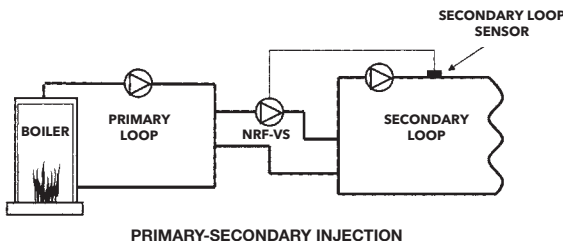

RELAYS ZONETROL II AZ-1A™ Snap-On Pump Relay

Description

The ZONETROL II AZ-1A snap on relay box is an easy to install single zone pump controller that mounts directly on any Bell & Gossett wet rotor circulator NRF/NBF or Series PL booster. The AZ-1A turns the pump and boiler ON as thermostat calls for heat. Using the wire nuts provided with the package, the AZ-1A is quickly assembled onto any NRF/NBF or 1/12 to 1/6 HP Series PL. The clearly marked TT terminals for the thermostat and the XX isolated end switch terminals make the rest of the hook-up a snap. The AZ-1A can be daisy-chained together to form a maximum of three zones.

The Bell & Gossett AZ-1A is ideal for any single to three zone pump application. Or can be used when adding a zone to an existing system. There's no more need to have a pump controller hanging on the wall, simply install the AZ-1A to our NRF/NBF or Series PL circulators and you are finished.



Features

- Snap-on design allows the AZ-1A to be quickly attached to any B&G wet rotor circulator, reducing your inventory investment (no need to carry "special" circulators with factory mounted controllers)
- Clearly marked terminals make for sure, fast wiring of the system
- Compact design fits in tight locations and presents a clean professional appearance
- 100% factory tested assures reliable operation
- 5 year warranty – the best in the industry
- Daisy-Chain the AZ-1A relays to form up to three zones
- Can be used on any B&G model NRF, NBF or 1/12 to 1/6 HP Series PL pumps

Specifications

Model No.	Part No.	Transformer	Relay	Power Input
AZ-1A	109423	2.5 VA	24 VAC / 5 amps	115 V, 60 Hz, 1Ø

Dimensions (L x W x H) 2-7/8" X 3-1/4" X 2-5/8"
 Approximate Shipping Weight 0.75 lbs



The AZ-1A can be daisy-chained to form up to three zones with simplified wiring.

Low voltage wiring makes multiple relay connections a snap.

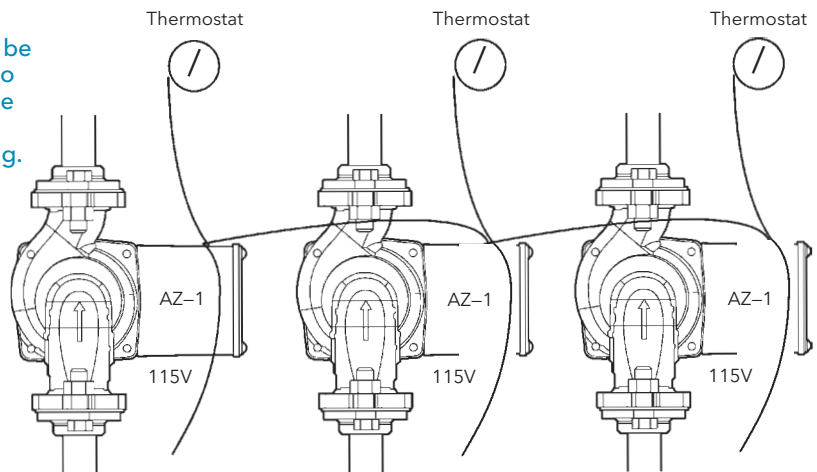

ZONETROL™ Switching Relays for Zoning with Valves

- 100% factory tested - guarantees operation
- Five year limited warranty - the best in the business
- Replaceable, standard "ice cube" type relays allow up to 10 amps, 1/3 HP per individual zone.
- Selectable priority for domestic hot water
- 30 minute built-in priority timer helps prevent house freeze up - no additional plug-in cards required
- Automatically resettable fuse protects controller from overload - eliminates "no heat" call backs due to blown fuse
- Powerful transformers operate up to six zones
- LED diagnostic lights installed internal to the box cover keeps the trouble shooting in the hands of the authorized heating professionals
- Can be used with "tankless coil" or "cold start" applications

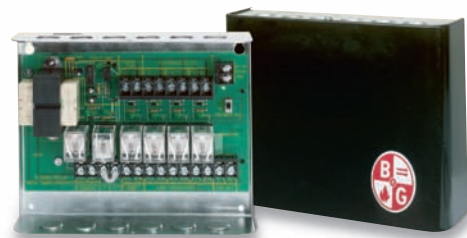

Specifications

Model No.	Part No.	Zones	Priority Feature	Transformer Output at 24 Volts	Relay Switching Action	Each End Switch Contact Rating	Dimensions W x H x D (Inches)	Approx. Shpg. Wt. (lbs.)
ZTV-4	109407	4	yes	40 VA	DPDT	5A, 1/8 HP @ 120 VAC	9 1/4 x 7 1/4 x 2 3/4	4.6
ZTV-6	109408	6	yes	75 VA	DPDT		11 3/8 x 7 1/4 x 3 3/4	6.9

RELAYS ZONETROL II Switching Relays with Reset Option for Zoning with Pumps

The next generation of zone controllers from Bell & Gossett brings 21st century technology to residential controls.



Description

Xylem's Bell & Gossett ZoneTrol II is a ready-to-install controller for hydronic circulators in residential and light commercial applications. All ZoneTrol II controllers are UL and cUL listed and feature multi-function LEDs that are visible without removing the cover for easy start-up and troubleshooting. All units are compatible with analog and digital 24 VAC thermostats, including "power stealing" designs. The multi-zone

controllers feature an advanced microprocessor design that provides domestic hot water (DHW) priority & timer, pump exercise and a post purge timer without the need for add-on circuit boards or modules.

Four and six zone controllers are field expandable for up to 18 pumps.

Specifications

Model Number	Part Number	Zones	Combined Load (max.) @ 120 VAC	Dimensions W x L x D Inches (mm)	Weight Lbs (kg)
Z-1	109424	1	5 amps	6.5 x 5 x 3 (165 x 127 x 76)	2.6 (1.18)
Z-2	109425	2	20 amps	6.5 x 5 x 3 (165 x 127 x 76)	3 (1.36)
Z-3	109426	3	20 amps	6.5 x 5 x 3 (165 x 127 x 76)	3.1 (1.4)
Z-4	109427	4	20 amps	13.5 x 8.25 x 3.25 (343 x 210 x 83)	7.3 (3.3)
Z-6	109430	6	20 amps	13.5 x 8.25 x 3.25 (343 x 210 x 83)	7.5 (3.4)
ZC-11*	109454	Communication cable for connection of multiple controllers			0.1 (0.05)

* fits 4 and 6 zone controllers only – one required for each slave controller.

Standard Features (multiple zone controllers only)

- Priority: Enables DHW zone to have priority over heating zones for limited period of time. User adjustable settings include OFF (disables priority functionality), 30 minutes and 60 minutes.
- Post Purge Timer: Circulator(s) will continue to run for 90 seconds after thermostat opens and allows additional extraction of BTUs from high mass boilers. User adjustable settings are OFF and ON.
- Exercise: Runs each circulator for 10 seconds after each 72 hours of inactivity. User adjustable settings are ON and OFF.
- Expandability: 4 and 6 zone controllers can easily be connected via an RJ-11 cable to accommodate systems consisting of up to 18 circulators.
- Five-year Warranty

BALANCE VALVES Lead-Free* Circuit Setter® Plus

Description

The Circuit Setter Plus and Circuit Setter Plus RF provide the perfect balance of adjustability and efficiency for potable water and HVAC systems. They are precisely calibrated for use as a presettable balance valve, variable orifice flow meter and positive shut-off service valve. They are also designed for optimal system efficiency and water conservation. The Circuit Setter Plus and Circuit Setter Plus RF can provide the perfect balancing solutions for your potable water and HVAC system.

Save time, energy and water with the lead-free Circuit Setter Plus and Circuit Setter Plus RF.

- Designed for all plumbing and HVAC systems.
- Provides equal flow throughout all circuits to conserve water and optimize system efficiency.
- Calibrated accurate flow control and measurement.
- Bi-directional design allows any installation configuration.
- Externally adjustable manual balance valve for easy adjustment.
- Reduces pump energy requirements.
- Meets or exceeds stringent codes for potable water.
- Includes memory stop indicator.
- Provides drain option.
- Provides positive shut off and isolation.
- Includes pressure/temperature ports.

Construction

Body Brass ASTM B283-C69300*
 Ball 304 Stainless Steel
 Seat Rings Glass and Carbon filled TFE
 Readout Valves Brass with EPT check valves
 Stem "O" Ring EPDM

Maximum Working Pressure

NPT Models 400 PSIG (2758 kPa)
 Sweat Models See table below

Maximum Operating Temperature

-4°F (-20°C) to 250°F (121°C)

* Contains less than 0.25% lead content by weight on wetted surfaces.
 CSA Certified: AB1953; Vermont S152; Maryland House Bill 372
 (Statute 12-605). ANSI/NSF-61 Annex G Compliant.



TYPE SOLDER	MAXIMUM PRESSURE LIMITATIONS FOR 1/2" - 1" WITH SOLDER CONNECTIONS	
	PRESSURE PSI KPA	TEMP °F (°C)
95-5 Tin-Antimony	300 (2068)	200 (93)
	250 (1724)	225 (107)
	200 (1379)	250 (121)

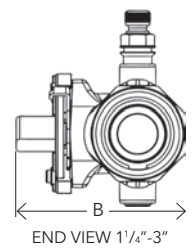
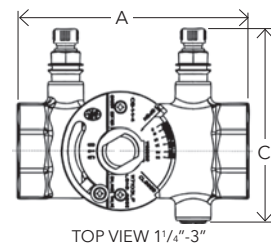
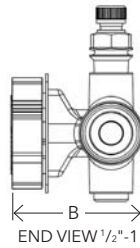
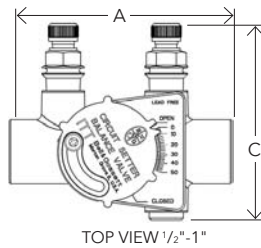

Specifications

MODEL NUMBER	SIZE	CONNECTION TYPE	DIMENSIONS** in inches (mm)			WEIGHT in lbs. (kg)
			A	B	C	
RF-1/2S LF	1/2"	Sweat	2.91 (73.9)	1.82 (46.2)	2.85 (72.4)	0.6 (0.27)
RF-3/4S LF	3/4"	Sweat	3.51 (89.2)	2.05 (52.1)	3.10 (78.7)	0.75 (0.34)
CB-1/2S LF	1/2"	Sweat	2.91 (73.9)	1.82 (46.2)	2.85 (72.4)	1 (0.45)
CB-3/4S LF	3/4"	Sweat	3.51 (89.1)	2.05 (52.1)	3.10 (78.7)	1.25 (0.6)
CB-1S LF	1"	Sweat	4.29 (109)	2.33 (59.2)	3.33 (84.6)	2 (0.91)
CB-1 1/4S LF	1 1/4"	Sweat	4.91 (124.7)	3.08 (78.2)	3.69 (93.7)	3.5 (1.6)
CB-1 1/2S LF	1 1/2"	Sweat	5.21 (132.3)	3.27 (83)	3.95 (100.3)	3.8 (1.7)
CB-2S LF	2"	Sweat	6.31 (160.3)	3.83 (97.3)	4.44 (112.8)	6.2 (2.8)
CB-1/2 LF	1/2"	NPT	2.94 (74.7)	1.98 (50.3)	3.02 (76.7)	1.25 (0.6)
CB-3/4 LF	3/4"	NPT	3.06 (77.7)	2.17 (55.1)	3.12 (79.2)	1.5 (0.7)
CB-1 LF	1"	NPT	3.81 (96.8)	2.47 (62.7)	3.42 (86.9)	2 (0.9)
CB-1 1/4 LF	1 1/4"	NPT	4.41 (112)	3.19 (81)	3.69 (93.7)	3.5 (1.6)
CB-1 1/2 LF	1 1/2"	NPT	4.42 (112.3)	3.37 (85.6)	3.95 (100.3)	3.8 (1.7)
CB-2 LF	2"	NPT	5.13 (130.3)	3.98 (101.1)	4.44 (112.8)	6.2 (2.8)
CB-2 1/2 LF	2 1/2"	NPT	6.00 (152.4)	4.51 (114.6)	4.83 (122.7)	9 (4.1)
CB-3 LF	3"	NPT	6.50 (165.1)	5.12 (130.0)	5.44 (138.2)	12 (5.4)

** All dimensions +/-0.125 (3.2 mm) tolerance. Dimensions are subject to change. Not to be used for construction purposes unless certified.

BALANCE VALVES Circuit Sentry™ Flo-Setter™

Description

The Circuit Sentry Flo-Setter valve is a field adjustable pressure independent flow limiter that maintains set flow rates regardless of pressure fluctuations in the system; eliminates overflow.

- The unique **GPM dial** is easy to set.
Requires no instruments, charts or wheels
- Saves pump energy and improves coil efficiency
- No minimum straight pipe lengths required
- Integrated pressure /temperature ports included
- Large open flow paths for clog-free operation

New GPM dial



Circuit Sentry Flo-Setter

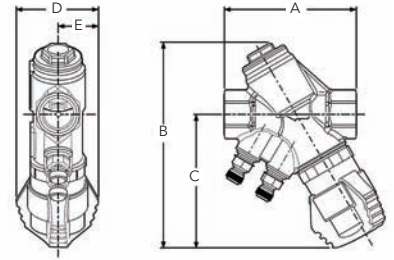

Construction

Body DZR Brass C35330
 DP Controller PPS 40% Glass
 Spring Stainless Steel
 Diaphragm HNBR
 O-Rings EPDM
 Ball Brass C37000
 Seat Teflon

Circuit Sentry Flo-Setter Specifications

MODEL NUMBER	SIZE	CONNECTION TYPE	DIMENSIONS* IN INCHES (mm)					FLOW CAPACITY IN GPM (L/HR)		APPROX. WEIGHT lbs. (kg)
			A	B	C	D	E	MIN.	MAX.	
CS-1/2	1/2"	NPT Female	3.8 (97)	5.8 (147)	3.8 (97)	2.4 (61)	1.2 (30)	0.18 (40)	4.84 (1,100)	2.0 (0.9)
CS-3/4	3/4"	NPT Female	3.8 (97)	5.9 (150)	3.8 (97)	2.4 (61)	1.2 (30)	0.31 (70)	8.15 (1,850)	2.0 (0.9)
CS-1	1"	NPT Female	4.1 (104)	6.1 (155)	4.1 (104)	2.4 (61)	1.2 (30)	0.44 (100)	10.35 (2,350)	2.2 (1.0)
CS-1-1/4	1 1/4"	NPT Female	5.2 (132)	7.4 (188)	4.5 (114)	2.4 (61)	1.2 (30)	0.88 (200)	21.13 (4,800)	3.7 (1.7)
CS-1-1/2	1 1/2"	NPT Female	5.7 (145)	8.1 (206)	4.7 (119)	2.4 (61)	1.2 (30)	1.76 (175)	32.76 (7,500)	5.3 (2.4)
CS-2	2"	NPT Female	6.1 (155)	8.6 (218)	5.0 (127)	2.4 (61)	1.2 (30)	2.20 (500)	45.46 (10,300)	7.5 (3.4)

Maximum Working Pressure

300 PSIG (2068 kPa)

Maximum Operating Temperature

-14°F (-10°C) to 230°F (110°C)

Control Range

Maximum 60 PSI (414 kPa) Delta P

Accuracy

+/- 5%

Model AM

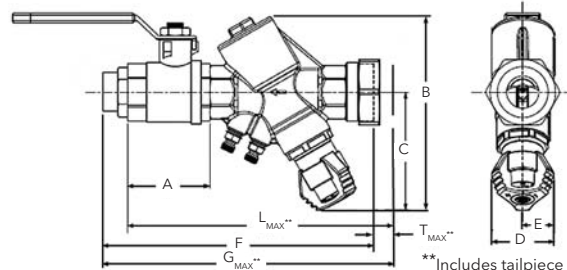

**Includes tailpiece (not shown).
 Measurement of maximum length tailpiece available.

Model AM Specifications (includes isolation valve and union tailpiece)

MODEL NUMBER	VALVE SIZE FIXED END	CONNECTION FIXED END	DIMENSIONS* IN INCHES (mm)								FLOW CAPACITY IN GPM (L/HR)		APPROX. WEIGHT lbs. (kg)	
			A	B	C	D	E	F	L MAX**	G MAX**	T MAX**	MIN.		MAX.
AM-1/2	1/2"	Sweat Female	1.7 (42)	5.8 (147)	3.8 (97)	2.4 (61)	1.2 (30)	6.7 (169)	7.6 (193)	8.2 (208)	1.55 (39)	0.18 (40)	4.84 (1,100)	2.5 (1.1)
		NPT Female	1.7 (42)	5.8 (147)	3.8 (97)	2.4 (61)	1.2 (30)	- (-)	7.6 (193)	- (-)	1.55 (39)	0.18 (40)	4.84 (1,100)	2.5 (1.1)
AM-3/4	3/4"	Sweat Female	2.1 (53)	5.9 (150)	3.8 (97)	2.4 (61)	1.2 (30)	7.5 (191)	8.1 (205)	9.1 (231)	1.55 (39)	0.31 (70)	8.15 (1,850)	2.7 (1.2)
		NPT Female	2.1 (53)	5.9 (150)	3.8 (97)	2.4 (61)	1.2 (30)	- (-)	8.1 (205)	- (-)	1.55 (39)	0.31 (70)	8.15 (1,850)	2.7 (1.2)
AM-1	1"	Sweat Female	2.5 (63)	6.1 (155)	4.1 (104)	2.4 (61)	1.2 (30)	8.3 (211)	9.1 (232)	10.3 (262)	2.00 (51)	0.44 (100)	10.35 (2,350)	3.3 (1.5)
		NPT Female	2.5 (63)	6.1 (155)	4.1 (104)	2.4 (61)	1.2 (30)	- (-)	9.1 (232)	- (-)	2.00 (51)	0.44 (100)	10.35 (2,350)	3.3 (1.5)
AM-1-1/4	1 1/4"	Sweat Female	3.1 (79)	7.4 (188)	4.5 (114)	2.4 (61)	1.2 (30)	10.2 (259)	11.0 (279)	12.2 (310)	2.00 (51)	0.88 (200)	21.13 (4,800)	5.7 (2.6)
		NPT Female	3.1 (79)	7.4 (188)	4.5 (114)	2.4 (61)	1.2 (30)	- (-)	11.0 (279)	- (-)	2.00 (51)	0.88 (200)	21.13 (4,800)	5.7 (2.6)
AM-1-1/2	1 1/2"	Sweat Female	3.4 (87)	8.1 (206)	4.7 (119)	2.4 (61)	1.2 (30)	11.7 (298)	12.9 (328)	14.3 (363)	2.52 (64)	1.76 (400)	32.76 (7,500)	7.9 (3.6)
		NPT Female	3.4 (87)	8.1 (206)	4.7 (119)	2.4 (61)	1.2 (30)	- (-)	12.9 (328)	- (-)	2.52 (64)	1.76 (400)	32.76 (7,500)	7.9 (3.6)
AM-2	2"	Sweat Female	4.4 (112)	8.6 (218)	5.0 (127)	2.4 (61)	1.2 (30)	13.7 (347)	15.1 (384)	16.8 (427)	3.14 (80)	2.20 (500)	45.46 (10,300)	11.9 (5.4)
		NPT Female	4.4 (112)	8.6 (218)	5.0 (127)	2.4 (61)	1.2 (30)	- (-)	15.1 (384)	- (-)	3.14 (80)	2.20 (500)	45.46 (10,300)	11.9 (5.4)

*All dimensions +/- 0.125" (3.2 mm) tolerance. Dimensions are subject to change. Not to be used for construction purposes unless certified.

**Includes tailpiece. Measurement of maximum length tailpiece available.

For Minimum Differential requirements please refer to submittal A-611A on our Web site. Maximum differential pressure is 60 PSID.

Minimum temperature is -14°F (-10°C) to 250°F (121°C). Maximum operating pressure is 290 PSI.

VALVES Flo-Control™ Valves

Flo-Control Valves

Prevent gravity flow in forced hot water systems, and permit summer/winter operation of indirect water heaters.

- Combination straight/angle configurations in sizes 3/4" to 2" for ease of installation.
- Removeable to cap allows easy cleaning and service without removing pipe connections.
- Manual operating position for vertical lift disc to permit gravity circulation.



Angle Pattern
2-1/2", 3"



Straight-Angle Pattern
3/4", 1", 1-1/4", 1-1/2", 2"



Bronze Straight
Pattern 3/4"



Straight Pattern
2-1/2", 3", 4"

Specifications

Model No.	Part No.	Dimension in Inches (mm)					Approx Shpg. Wt. lbs. (Kg)
		A	B	C	D	E	
SA 3/4	107034	3 1/8 (79)	4 15/16 (125)	1 5/8 (41)	1 9/16 (40)	1 7/16 (37)	2 (0.9)
SA 1	107018	3 1/2 (89)	5 1/2 (140)	1 7/8 (48)	1 3/4 (44)	1 1/2 (38)	3 (1.4)
SA 1 1/4	107019	4 (102)	6 1/2 (165)	2 1/4 (57)	1 31/32 (50)	1 7/8 (48)	4 (1.8)
SA 1 1/2	107020	5 (127)	7 1/4 (184)	3 (76)	2 1/2 (64)	2 1/4 (57)	8 (3.6)
SA 2	107021	6 7/8 (175)	7 1/2 (191)	4 5/8 (117)	4 (102)	2 5/8 (67)	12 (5.5)
A 2 1/2	107006	7 1/4 (184)	7 5/8 (194)	5 3/8 (137)	4 1/2 (114)	4 1/8 (105)	20 (9.1)
A 3	107007	7 1/2 (191)	7 3/4 (197)	6 (152)	4 1/2 (114)	4 1/4 (108)	23 (10.5)
S 2 1/2	107014	9 5/16 (237)	8 11/16 (221)	5 3/8 (137)	4 3/4 (121)	2 11/16 (68)	22 (10.0)
S 3	107015	9 15/16 (252)	9 (229)	6 (152)	5 1/4 (133)	3 (76)	24 (10.9)
S 4	107004	13 (330)	12 1/2 (318)	7 3/4 (197)	7 (178)	3 7/8 (98)	58 (26.4)
SB 3/4	107024	3 1/4 (83)	3 7/8 (98)	1 7/16 (37)	1 5/8 (41)	23/32 (18)	1.2 (0.6)

Dimensions are approximate and subject to change. Contact factory for certified dimensions.

Maximum Operating Temperature: 250°F (121°C) - Maximum Working Pressure: 125PSIG (862KPa)

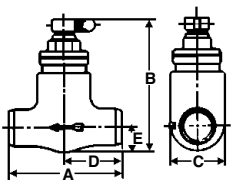

Sizes 3/4"
Bronze Straight Valve

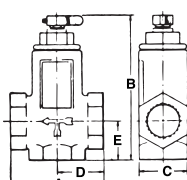

Sizes 3/4", 1", 1-1/4", 1-1/2"
Straight Angle Valves

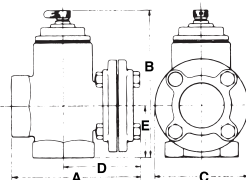

Sizes 2"
Straight Angle Valves

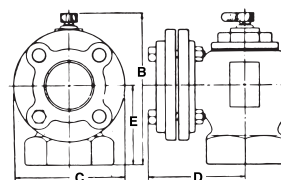

Sizes 2-1/2", 3"
Angle Valves

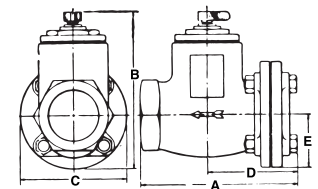

Sizes 2-1/2", 3", 4"
Straight Valves

VALVES Hydrotrol™ Flow Control Valves

Description

The Hydrotrol (HT) flow control valve is used to prevent overheating of zones due to gravity flow in hydronic heating systems and will permit summer-winter operation of indirect water heater. The HT valve allows fluid to pass when the system or zone pumps start. When the system or zone pumps are not operating, the HT valve remains closed, preventing gravity circulation. The HT valves are designed with a 1/2 turn knob that can be manually opened when draining the system or for bypass purposes. The HT valve can be installed in either the horizontal or vertical orientation.



Operating Data

Maximum working pressure 150 PSI (10 bar)
 Maximum operating temperature 250°F (121°C)

Materials of Construction

Body Brass
 Internal Components Non-Ferrous

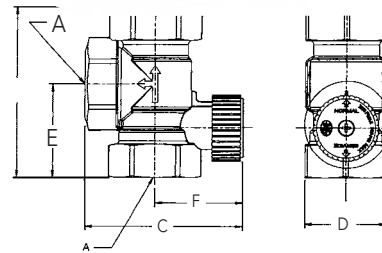

Specifications

Model No.	Part No.	Dimensions — Inches (mm)						Approx. Shpg. Wt. lbs. (Kg)
		A	B	C	D	E	F	
HT-3/4	107035	3/4" NPTF	3-3/16" (82)	3" (76)	1-9/16" (40)	1-3/4" (44)	1-11/16" (43)	1.3 lbs. (0.6)
HT-1	107037	1" NPTF	3-5/8" (93)	3-3/16" (82)	1-9/16" (40)	1-15/16" (50)	1-11/16" (43)	1.2 lbs. (0.5)
HT - 1-1/4	103038	1-1/4" NPTF	4" (101)	3-11/16" (93)	1-11/16" (43)	2-1/4" (57)	1-7/8" (48)	1.8 lbs. (0.8)

Do not use for construction. Dimensions are approximate and subject to change. Contact factory for certified dimensions.

VALVES DB-Differential Bypass Valve

Description

The differential bypass valve is used in systems where heating loads may be excluded from the circuit as zone valves close. It controls the excess flow in the system by acting as a bypass while ensuring adequate flow to the remaining open circuits. The differential bypass valve helps reduce velocity noise caused by excess flow through the circuits while maintaining the pump head at a constant value.

For hydronic systems utilizing zone valve

- Controls excess flow in the system when there is reduction in demand
- Available in 3/4" connection
- All brass body with non-ferrous internals

Operating Data

Maximum working pressure: 150 PSIG (1,034 kPa)
 Maximum operating temperature : 230°F (110 °C)
 Adjustment range: 2 to 10 PSI

Materials of Construction

Valve body Brass
 Seals EPDM
 Spring Stainless Steel
 Knob ABS

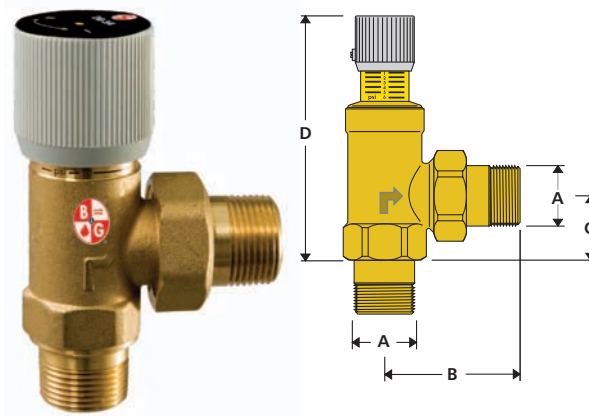

Specifications

Model Number	Part Number	A (mm)	B (mm)	C (mm)	D (mm)	Connection Type	Weight (LB)
DB-3/4	113247	3/4" (19)	2-5/16" (59)	1" (26)	4" (104)	M NPT	1

VALVES Pressure Reducing Valves

Reducing Valves fill the system to a preset pressure for optimum performance.

- Fast fill feature reduces start-up time and labor.
- Low inlet pressure check valve helps prevent loss of system pressure if the supply water drops below system pressure.
- Convenient cleanable strainer is designed to prevent dirt and sediment from entering the system.
- Union connection available with 1/2" male NPT thread and 1/2" female sweat tail-piece for fast, flexible system connection.
- Brass body construction is highly resistant to corrosion - ideal for water systems.

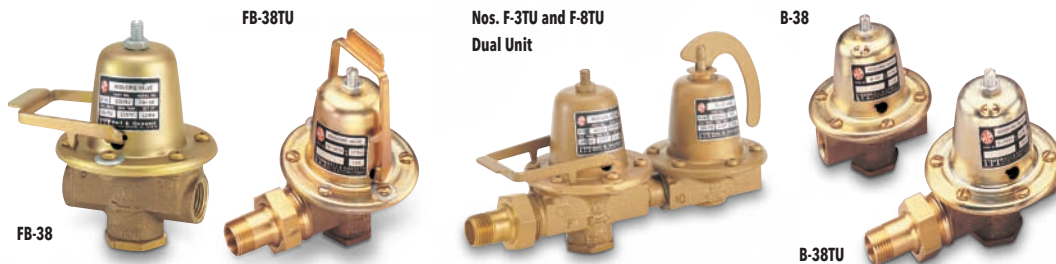

Specifications for Combination "Dual Units"

Model No.	Part No.	Component Valves	Body Material	Connection in Inches		Dimensions in Inches (mm)		Approx. Shpg. Wt. lbs. (Kg)
				Boiler	Fill	Between Connections	Overall Height	
8	110199	Relief	Iron	1/2 NPT	1/2 NPT	6 7/16 (164)	5 3/8 (137)	4 (1.8)
F-3	110197	B-38	Brass		1/2 NPT	6 7/16 (164)	6 (152)	3 3/4 (1.7)
F-3TU	110198	Relief	Brass		1/2 Union	8 5/8 (219)		
		FB-38TU	Brass		NPT/Sweat			

PRESSURE SETTING:

Relief 30 PSI

Reducing 12 PSI standard; field adjustable range: 10 - 25 PSI

Maximum operating temperature 225°F (107°C) - Maximum operating pressure 125 PSIG (862 kPa)

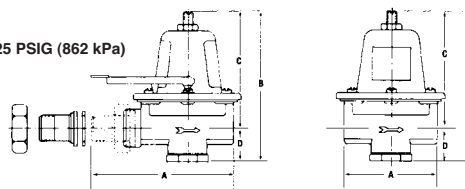

Specifications for Pressure Reducing Valve

Model No.	Part No.	Body Material	Connection Size - Inches		Factory Setting (PSIG)	Adjustable Range (PSIG)	Dimensions in Inches (mm)				Approx. Shpg. Wt. lbs. (Kg)
			A	B			C	D			
B-38	110190	Brass	1/2	NPT	12	10 - 25	3 1/16 (78)	4 13/16 (122)	3 11/16 (94)	1 1/8 (29)	1 3/4 (0.8)
B7-12	110196		3/4				3 (76)	4 31/32 (126)	3 21/32 (93)	1 5/16 (33)	2 1/4 (1.0)
B-38TU	110191		1/2	Union*			4 31/32 (126)	4 13/16 (122)	3 11/16 (94)	1 1/8 (29)	2 (0.9)
FB-38	110192		1/2	NPT			3 1/16 (78)				1 3/4 (0.8)
FB-38TU	110193		1/2	Union*			4 31/32 (126)	2 (0.9)			
6	110194		1/2	NPT			3 1/16 (78)	1 3/4 (0.8)			
7	110195		3/4				3 (76)	4 31/32 (126)	3 21/32 (93)	1 5/16 (33)	2 1/4 (1.0)

* Models ending in "TU" feature 1/2" sweat/NPT union connection

ASME Safety Relief Valves

ASME Safety Relief Valves

Protect fired and unfired hot water vessels against hazardous operating pressures.

- Engineered in accordance with Section IV of the ASME boiler & pressure code for heating boilers with capacities certified by the National Board of Boiler and Pressure Vessel Inspectors.
- Offer the highest BTUH ratings available on the market today for valves in their class (790,000 to 5,999,000 BTUH)
- EPDM diaphragm operated (cast iron models) and diaphragm assisted (bronze models) have an effective area approximately 5 times greater than conventional "pop-type" relief valves to help overcome the effects of fouling.
- Low differential between opening and closing pressures helps to prevent conditions under which system water might flash to steam and cause hammering.



Nos. 3301 & 4100



Nos. 790 & 1170

Models 3301 & 4100 Iron Body Valves

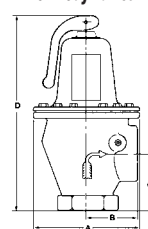

Models 790 & 1170 Bronze Body Valves

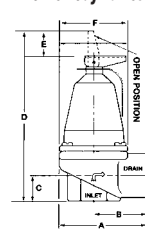

Size, Capacity & Relief Setting for B&G ASME Safety Relief Valves ¹				
Relief Setting PSIG	Model Number Capacity in BTU Per Hour			
	Iron Body		Bronze Body	
	30	3301-30 3,300,000	4100-30 4,100,000	790-30 790,000
36	3301-36 3,800,000	4100-36 4,600,000	790-36 900,000	1170-36 1,330,000
45	3301-45 4,500,000	4100-45 5,515,000	790-45 1,065,000	1170-45 1,575,000
50	3301-50 4,900,000	4100-50 5,990,000	790-50 1,160,000	1170-50 1,710,000
75	NOT AVAILABLE		790-75 1,615,000	1170-75 2,385,000
100			790-100 2,075,000	1170-100 3,060,000
125			790-125 2,535,000	1170-125 3,735,000

¹ Contact your local wholesaler or Bell & Gossett representative for availability of ASME Safety Relief Valves with special pressure settings.

Specifications

Model No.	Body	NPT Connections in Inches		Dimension in Inches (mm)						Approx Shpg. Wt. lbs. (Kg)
		Inlet	Outlet	A	B	C	D	E	F	
790	Brass	3/4	3/4	2 9/16 (65)	1 1/2 (38)	3/4 (19)	4 9/16 (116)	1 1/32 (26)	2 3/32 (53)	1.2 (0.5)
1170		1	1	2 7/8 (73)	1 3/4 (44)	7/8 (22)	4 15/16 (125)		2 1/4 (57)	1.5 (0.7)
3301		1 1/2								
4100	Iron	2	2	6 (152)	2 7/8 (73)	3 1/4 (83)	11 (279)	N/A		17 (7.7)

Actual unit model numbers include individual valve pressure settings as a suffix to the basic valve model number noted.

Dimensions are approximate and subject to change. Contact factory for certified dimensions.

Maximum Operating Temperature: 250°F (121°C) - Maximum Working Pressure: Model 790 & 1170: 125PSIG (862KPa); Model 3301 & 4100: 50 PSIG (345 KPa).

ACCESSORIES Copper Red Ring Monoflo® Fittings

Description

Copper Red Ring Monoflo Fittings let you use a single pipe to serve as both supply and return main.

- Connect risers to the main, assuring proper diversion of water to each heating unit regardless of type and its position in the system.
- Recommended for most installations including cast iron non-ferrous base boards, free-standing radiation or convectors.
- Only one fitting is needed for most installations for adequate diversion for upfeed radiation. For most applications, a second fitting can be used if higher resistance is required.

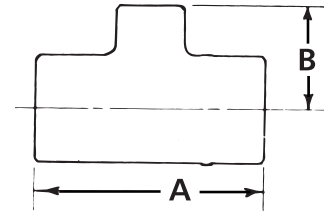

Specifications

Part No.	Size - Inches	Dimensions - Inches (mm)		Cv Ratings*		Approx. Shpg. Wt. lbs. (Kg)
		A	B	1 FTG	2 FTG	
108119	3/4 x 1/2**	2 5/16 (59)	1 1/32 (26)	4.2	-	1/4 (0.1)
108120	1 x 1/2	2 3/4 (70)	1 7/32 (31)	14.5	8.7	1/2 (0.2)
108121	1 x 3/4	2 29/32 (74)	1 7/16 (37)			
108122	1 1/4 x 1/2	2 15/16 (75)	1 9/32 (33)	24	15.5	
108123	1 1/4 x 3/4	3 7/32 (82)	1 1/2 (38)			
108124	1 1/2 x 3/4	3 7/16 (87)	1 21/32 (42)	39	25	1 1/4 (0.6)
108125	1 1/2 x 1	3 5/8 (92)	1 7/8 (48)			
108126	2 x 3/4	3 7/8 (99)	2 (51)	80	55	1 3/4 (0.8)
108127	2 x 1	4 3/8 (111)	2 5/32 (55)			

* With side branch plugged

** Return only

Maximum working pressure 150 PSIG (1,034 kPa) - Maximum operating temperature 300° F (149° C).

AIR SEPARATORS In-Line Air Separator

Description

The B&G In-Line Air Separator is specifically designed to efficiently separate air from circulating water in hydronic heating and cooling systems to assure a quiet operation.

Operating Data

Maximum working pressure 175 PSIG (1,207 kPa)
Maximum operating temperature 300°F (149°C)

Construction

One Piece Cast Iron



Specifications

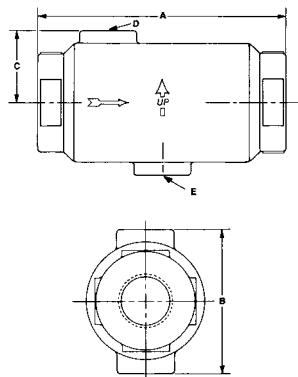

Model No.	Part No.	Size NPT	Max Flow (GPM)	Dimensions – Inches (mm)					Approx. Shpg. Wt. (Lbs)
				A	B	C	D	E	
IAS -1	112118	1"	15	6-1/8	3-1/2	1-3/4	1/8 NPT		3-3/4
IAS - 1-1/4	112119	1-1/4"	25	(156)	(89)	(45)			3-1/2
IAS- 1-1/2	112097	1-1/2"	35	8-1/8	4-1/2	2-1/4	3/4 NPT	1/2 NPT	8-1/2
IAS- 2	112098	2"	50	(207)	(114)	(57)			7-1/2
IAS- 2-1/2	112099	2-1/2"	75	10-1/8	6-3/8	3-3/16			23
IAS- 3	112100	3"	125	(257)	(257)	(81)			21-1/2

Dimensions are approximate and subject to change. Contact factory for certified dimensions.

AIR SEPARATORS EASB-Jr Enhanced Air Separator

Description

Bell & Gossett's Model EASB-JR Enhanced Air Separator automatically removes entrained air bubbles in hydronic systems. As fluid enters the EASB-JR, the velocity is decreased creating a low pressure area. The small bubbles are released from fluid and then collected on the coalescing medium. As the bubbles coalesce, they rise to the top of the air separator where they are released to atmosphere through the built-in automatic air vent. The air separator has a bottom 1/2" NPT connection to accommodate a B&G diaphragm expansion tank. The compact design and brass body construction make the EASB-JR ideal for residential and commercial hydronic heating systems.

Operating Data

Maximum working pressure 150 PSI (10 bar)
Maximum operating temperature 250°F (121°C)

Materials of Construction

Body & Cap Brass
Coalescing Medium Stainless Steel
Venting Mechanism Non-Ferrous

Dimensions & Weights

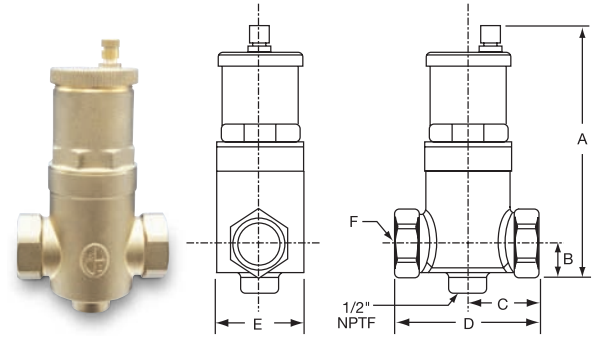

Specifications

Model Number	Part Number	Size	Dimension in Inches (mm)						Approx. Shpg. Wt. Lbs. (Kg)
			A	B	C	D	E	F	
EASB-3/4 JR	112111	3/4" NPT	6 7/8 (175)	1 5/8 (41)	1 13/16 (46)	3 5/8 (92)	2 1/4 (57)	3/4" NPTF	2.5 (1)
EASB-3/4S JR	112114	3/4" Sweat	6 7/8 (175)	1 5/8 (41)	1 13/16 (46)	3 5/8 (92)	2 1/4 (57)	3/4" Sweat	2.5 (1)
EASB-1 JR	112112	1" NPT	6 7/8 (175)	1 5/8 (41)	1 13/16 (46)	3 5/8 (92)	2 1/4 (57)	1" NPTF	2.5 (1)
EASB-1S JR	112115	1" Sweat	6 7/8 (175)	1 5/8 (41)	1 13/16 (46)	3 5/8 (92)	2 1/4 (57)	1" Sweat	2.5 (1)
EASB-1 1/4 JR	112113	1 1/4" NPT	7 1/2 (191)	1 7/8 (48)	2 5/16 (59)	4 5/8 (117)	3 1/8 (79)	1 1/4" NPTF	4 (1.8)
EASB-1 1/4S JR	112116	1 1/4" Sweat	7 1/2 (191)	1 7/8 (48)	2 5/16 (59)	4 5/8 (117)	3 1/8 (79)	1 1/4" Sweat	4 (1.8)
EASB-1 1/2 JR	112117	1 1/2" NPT	7 1/2 (191)	1 7/8 (48)	2 5/16 (59)	4 5/8 (117)	3 1/8 (79)	1 1/2" NPTF	4 (1.8)
EASB-2 JR	112464	2" NPT	7 1/2 (191)	2 (51)	2 1/2 (64)	5 (127)	3 1/8 (79)	2" NPTF	5 (2.3)

Dimensions are approximate and subject to change. Contact factory for certified dimensions.

Enhanced Air Separator

Description

Bell & Gossett's Model EAS Enhanced Air Separator is a patented, innovative design in air separators. It has been engineered to remove entrained air from hydronic heating and cooling systems providing far superior air removal compared with other devices available today. The EAS is ideal for residential, institutional and light commercial applications.

Specifications

Model No.	Part No.	Max. Flow (GPM)	Size Inches NPT	Dimensions — Inches (mm)					Approx. Shpg. Wt. lbs. (Kg)
				A	B	C	D	E	
EAS-1	112105	35	1	12-3/16 (310)	6-7/8 (175)	6-7/16 (164)	3-15/16 (100)	3 (76)	8.8 (4)
EAS-1	112106	35	1-1/4	12-3/16 (310)	6-7/8 (175)	6-7/16 (164)	3-15/16 (100)	3 (76)	8.4 (3.8)
EAS-1	112107	45	1-1/2	15-3/4 (400)	11-3/8 (289)	8-5/8 (219)	4-7/8 (124)	4-1/4 (108)	15.5 (7)
EAS-2	112108	70	2	17-1/2 (445)	11-3/8 (289)	8-5/8 (219)	4-7/8 (124)	4-1/4 (108)	15.25 (6.9)

EAS-1 or EAS- 1-1/4 Max. Width 4-1/16" (103mm)

EAS- 1-1/2 or EAS-2 Max. Width 5-3/4" (146mm)

Operating Data

Maximum working pressure . . . 150 PSI (10.3 bar)
Maximum operating temperature . . 250°F (121°C)

Materials of Construction

Body & Cap Cast Iron
Internals Stainless Steel
3/4" Large Capacity Air Vent Brass Body
Nonferrous Internals

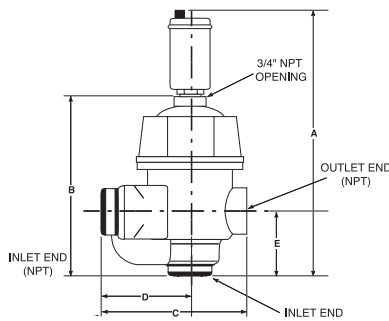

How It Works

- As system fluid enters through the inlet, (either straight or angle) the diffuser distributes flow evenly across the stainless steel, wire brush-like medium.
- Air bubbles, even micro air bubbles, stick to the brush filaments.
- Trapped air rises above the diffuser through a baffle (not pictured), where the air is then released through an opening on top.
- Deaerated water then goes back into the system.

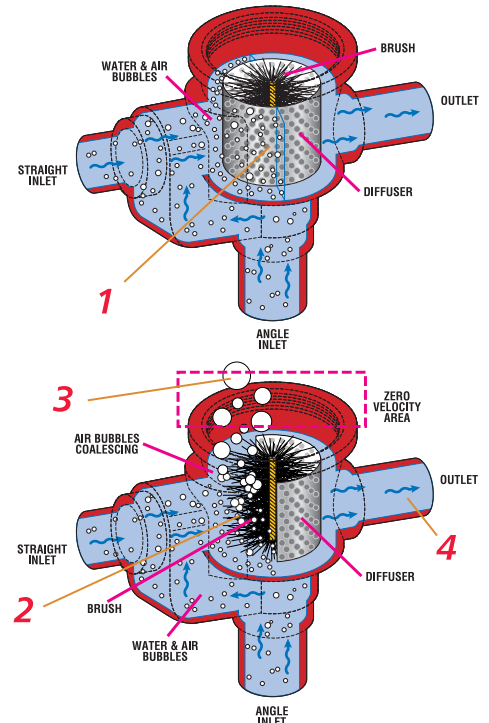

HYDRONIC SPECIALTIES

RV-125A Readout Valve and RP-250B Readout Probe

The RV-125A is designed for use wherever pressure tappings are required to monitor flow or pressures. The Readout Valve is fitted with an EPT insert which incorporates a unique check valve feature designed to check flow when the Readout Valve is not being used to monitor flow. Use companion RP-250B Readout Probes with the RV-125A Readout Valve. **300 PSIG Working Pressure – 250°F Maximum Operating Temperature**



RV-125 RP-250

TB- Thermoflo® Balancer

A device for instant visual balancing of hot or cold water flows. With a B&G Thermoflo balancer installed in each circuit or zone, the entire system can be quickly balanced to meet original design calculation. No. TB-3/4" - Capacity 1 to 5 GPM. No. TB-1" - Capacity 2 to 10 GPM. **125 PSIG Working Pressure – 250°F Maximum Operating Temperature**



DT-2 Drain-O-Tank® Air Charger

The Drain-O-Tank Air Charger offers a sure, quick way to recharge a water-logged compression tank. **125 PSIG Working Pressure – 240°F Maximum Operating Temperature**



AIR VENTS

Model No. 107A High Capacity Air Vent

A rugged High Capacity Air Vent designed to purge free air from liquid systems at **operating pressures up to 150 PSIG**. The Model 107A Air Vent has a cast iron body and bonnet, with stainless steel, brass and EPDM internal components and is suitable for a **maximum operating temperature of 250°F**. The Air Vent has a **3/4" NPT inlet and 3/8" NPT outlet**.



No. 97 Automatic Air Vent

A float type vent designed to vent troublesome air from hydronic heating systems. The brass body and the non-ferrous internals provide years of reliable service. The compact design (3-1/8" x 1-7/8") and high operating pressure/temperature (**240°F @ 150 PSIG**) limitations make the No. 97 a must in any hydronic heating system.



No. 26 Vacuum Breaker

Designed to protect closed vessels and piping systems against collapse when the induced vacuum exceeds design conditions. When used on steam heating systems, the No. 26 Vacuum Breaker controls induced vacuum, permitting normal return of condensate to the boiler. Adjustable range 1/4" to 20" (mercury) vacuum. Factory set to 4" – **150 PSIG Maximum Working Pressure – 300°F Maximum Operating Temperature**



No. 98

A high capacity automatic air vent that is designed to remove air in closed loop systems. Materials of construction: Brass body with non-ferrous internals. **Maximum working pressure: 150 PSI. Maximum operating temperature: 250°F**



No. 87, 67 and 7 Automatic Air Vents

Designed to vent the accumulation of troublesome air wherever it can be trapped. These non-ferrous automatic air vents are 4-3/4" x 2-1/4", 3-3/16" x 1-1/2" and 4-1/16" x 2-3/16" (height and width), respectively, and are rated for a **maximum operating temperature of 240°F at pressures of 150, 35 and 75 PSI, respectively**. The No. 87 has a combination of 1/2" FPT/3/4" MPT connection, whereas No's. 67 and 7 have 1/8" MPT, and FPT connections.



No. 4V "Coin-Operated" Air Vent

Specially designed for the new types of radiators. An important feature is that it projects only slightly, being almost flush with the radiator. **150 PSIG Working Pressure – 250°F Maximum Operating Temperature**



Specifications

Model No.	Part No.	Description	System Connection	Dimensions (W x H)	Maximum		Approx. Shpg. Wt. (Lbs) Carton Of	
					Pressure	Temperature		
98	113246	Automatic Air Vent	3/4" NPTM	4-1/2" x 9-5/8"	150 PSIG	250F	10	8
97	113222		1/8" NPTM	1-7/8" x 3-1/8"			10	8
87	113021		Combination	2-1/4" x 4-3/4"			12	8
67	113020		3/4" NPTM 1/2" NPTF	1-1/2" x 3-3/16"	35 PSIG	3		
7	113001		1/8" NPTF	2-3/16" x 4-1/16"	75 PSIG	6		
107A	113076		High Capacity Air Vent	3/4" NPTF	4-1/2" x 9-5/8"	150 PSIG	250F	1
4V	113055	Manual Air Vent	1/8" NPTM	5/8" x 5/8"	150 PSIG	250F	48	2
26	113075	Vacuum Breaker	3/4" NPTM	1-1/4" x 3"	150 PSIG	300F	6	3
RV-125A	113100	Readout Valve	1/8" NPTM	1-1/8" x 9/16"	300 PSIG	250F	50 pairs	4
RP-250B	113102	Readout Probe	N/A	2" x 5/8"	300 PSIG	250F	6 pairs	1
DT-2	113041	Drain-O-Tank	1/2" NPTM	2-1/4" x 6-5/16"	125 PSIG	240F	12	8
TB-3/4	127001	Balance Valve	3/4" NPTF	2" x 9-1/4"	125 PSIG	250F	6	26
TB-1	127002	Balance Valve	1" NPTF	2" x 9-1/4"	125 PSIG	250F	6	26

ACCESSORIES PSH - Primary/Secondary Header

Description

The B&G low-loss header, Model PSH, is a combination air separator and manifold that creates independent primary and secondary circuits. The B&G Model PSH is equipped with a purge valve allowing the user to remove any debris deposited on the bottom of the vessel and an air vent releasing trapped air in the system. The insulation, which is provided as a standard, prevents water vapors entering from the outside and eliminates the formation of condensate on the PSH body.

Operating Data

With Insulation
 Working pressure150 PSI
 Operating temperature Threaded 32° - 210°F
 Operating temperature Flanged 32° - 220°F
 Without Insulation
 Working pressure150 PSI
 Operating temperature Threaded & Flanged. .32°-230°F

Materials of Construction

Materials of Construction
 Body Steel
 Air Vent Brass
 Drain Valve Brass
 Insulation-Threaded PEX
 Insulation-Flanged Polyurethane Foam

Connection

1", 1-1/4" and 1-1/2" Female NPT
 2", 2-1/2", 3" and 4" ANSI 150 CLASS Flange

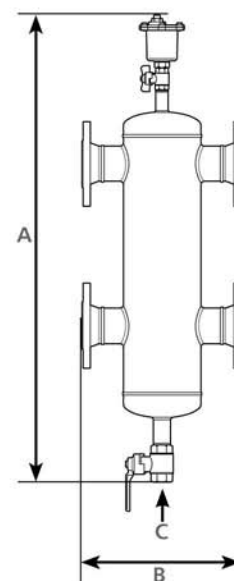
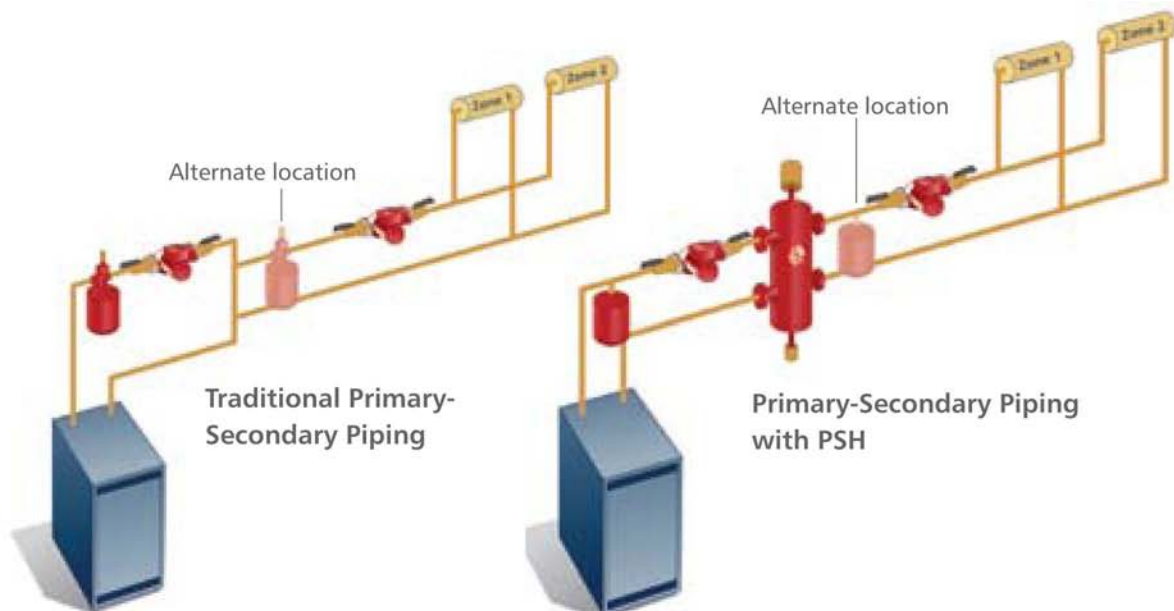

Specifications

Model Number	Part Number	Connection Size Inches (mm)	Max Flow GPM (m3/h)	A Inches (mm)	B Inches (mm)	C - Drain Connection Size Inches (mm) NPT	Weight LBS (Kg)
PSH-1	112465	1 (25.4)	11 (2.5)	24-3/8 (619)	8-7/8 (225)	1/2 (12.7)	6.0 (2.7)
PSH-1.25	112466	1-1/4 (31.75)	18 (4)	26-3/4 (679)	9-3/4 (248)	1/2 (12.7)	8.3 (3.8)
PSH-1.5	112467	1-1/2 (38.1)	26 (6)	28-1/3 (719)	11-1/8 (282)	1/2 (12.7)	12.6 (5.7)
PSH-2	112468	2 (50.8)	40 (9)	42 (1069)	13-13/16 (350)	1-1/4(31.7)	78.7 (35.7)
PSH-2.5	112469	2-1/2 (63.5)	80 (18)	42 (1069)	13-13/16 (350)	1-1/4(31.7)	87.7 (39.8)
PSH-3	112470	3 (76.2)	124 (28)	50-3/8 (1279)	18-3/8 (466)	1-1/4(31.7)	108.0 (49)
PSH-4	112471	4 (101.6)	247 (56)	50-3/8 (1279)	18-1/2 (470)	1-1/4(31.7)	116.8 (53)

TANKS HFT Diaphragm Tanks • Expansion Tanks for Hydronic Heating

Bell & Gossett HFT expansion tanks are designed to absorb the force of thermal expansion in hydronic heating systems. Series HFT tanks for hydronic heating systems are available in sizes from 2–86 gallons. The Series HFT tank is designed to absorb the force of thermal expansion of heating water to maintain proper pressurization in a closed hydronic system. The heavy duty butyl diaphragm separates system water from the air in the tank preventing water logging problems.

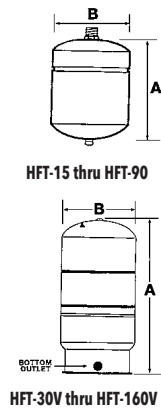

Specifications

Model Number	Part Number	Volume Gallons (Liters)		Height (A) Inches (mm)	Diameter (B) Inches (mm)	System Connection	Approx. Shpg. Wt. lbs. (Kg)
		Tank	Acceptance				
HFT-15	1BN201	2 (7.5)	1.0 (3.7)	12-5/8 (321)	8 (203)	1/2" NPTM	5 (2.3)
HFT-30	1BN202	4.4 (16.6)	2.5 (9.4)	15-1/2 (394)	11 (279)		9 (4.1)
HFT-60	1BN203	7.6 (28.7)	2.5 (9.4)	23 (584)	11 (279)		14 (6.4)
HFT-90	1BN204	14 (53)	11.3 (42.8)	21 (533)	15-3/8 (390)	1" NPTF	23 (10.4)
HFT-30V	1BN205	14 (53)	11.3 (42.8)	24-3/4 (629)	15-3/8 (390)		25 (11.3)
HFT-40V	1BN206	20 (75.7)	11.3 (42.8)	32-1/2 (826)	15-5/8 (390)		33 (14.9)
HFT-60V	1BN207	32 (121.1)	11.3 (42.8)	47-1/2 (1207)	15-5/8 (390)	1-1/4" NPTF	43 (19.5)
HFT-90V	1BN208	44 (166.5)	34 (128.7)	36 (914)	22 (559)		69 (31.2)
HFT-110V	1BN209	62 (234.6)	34 (128.7)	46-3/4 (1186)	22 (559)		92 (41.7)
HFT-160V	1BN210	86 (325.5)	46 (174.1)	47-1/4 (1199)	22 (559)	123 (55.8)	

Materials: Steel Shell Diaphragm
 System Connection: Steel
 Maximum Operating Temperature=240F (116C); Maximum Working Pressure= 100 PSI (689 kPa);
 Standard Factory Precharge=12 PSI (83 kPa)

Operating Data

Maximum working pressure 100 PSI (689 kPa)
 Maximum operating temperature 240°F (115°C)

Materials of Construction

Shell Carbon Steel
 Diaphragm Heavy Duty Butyl Rubber



Sizing Guideline

Boiler Size	Type of Radiation			
	Finned Tube Baseboard or Radiant Panel	Convectors or Unit Heaters	Radiators Cast Iron	Baseboard Cast Iron
Net Output				
BTU/HR	Use Tank Model			
25,000	HFT-15	HFT-15	HFT-15	HFT-15
50,000	HFT-15	HFT-15	HFT-30	HFT-30
75,000	HFT-30	HFT-30	HFT-30	HFT-60
100,000	HFT-30	HFT-60	HFT-60	HFT-60
125,000	HFT-30	HFT-60	HFT-60	HFT-90
150,000	HFT-30	HFT-60	HFT-90	HFT-90
200,000	HFT-60	HFT-60	HFT-30V	HFT-30V
250,000	HFT-30	HFT-90	HFT-30V	HFT-40V
300,000	HFT-90	HFT-30V	HFT-30V	HFT-40V
350,000	HFT-30V	HFT-30V	HFT-40V	HFT-60V
400,000	HFT-30V	HFT-40V	HFT-40V	HFT-60V

Assumptions: fill pressure 12 PSI, relief pressure 30 PSI, avg. system temp. 200 °F, system fluid is water, consult factory with requirements not shown

Compression Tanks

Air-tight, ASME constructed. Available in painted steel.
 Sizes 15 to 505 gallons. Gauge glass tapplings are standard.
 Always use with B&G Airtrol Tank Fittings.



Airtrol® Tank Fittings

Directs free air to the compression tank. Restricts thermal circulation to boiler. Establishes initial tank air level. Allows compression tank size reduction.



Specifications

Model No.	Part No.	Capacity Gallons	Required Airtrol Fitting	Tank Dia. Inches	Tank Length Inches	Approx. Shpg. Wt. (Lbs)
15	116029	15	ATF-12	12	33	50
24	116030	24			51	72
30	116031	30			48	80
40	116032	40			63	104
60	116033	60	ATF-16	16	72	134
80	116034	80	ATF-20	20	62	160
100	116035	100	ATF-20		78	186
120	116036	120	ATF-24		65	217
135	116037	135			72	230
175	116038	175		62-1/4	320	
220	116039	220	ATFL	30	77	370
240	116040	240			84	420
305	116041	305			105-3/4	482
400	116042	400			93	656
505	116840	505			116	745

Dimensions are approximate and subject to change. Consult factory for certified dimensions.
 Part numbers in table above are for paint steel tanks.

Specifications

Model No.	Part No.	Tank Dia. Inches	Connection (NPT)		Approx. Shpg. Wt. (Lbs)
			Tank	Boiler	
ATF-9	112008	9	1/2" M	3/4" M	2-1/4
ATF-12	112010	12 - 14			2-1/2
ATF-16	112011	16 - 18			2-3/4
ATF-20	112026	20 - 22			
ATF-24	112013	24	1" F	1" F	14
ATFL	112014	>100 gal			

TANKS PT Diaphragm Tanks

Expansion Tanks for Potable Water Systems

Bell & Gossett PT expansion tanks are designed to absorb the force of thermal expansion in domestic potable water systems. Tanks for potable water systems, Series PT and PTA (ASME construction) are available in sizes from 2–528 gallons.



Residential/Light Commercial Non-ASME Diaphragm Tanks

Maximum working pressure:
 PT-5 & PT-12 150 PSI (1035 kPa)
 PT-25V thru PT-210V 100 PSI (689 kPa)
 Maximum operating temperature 200°F m (93°C)

Materials of Construction

Shell Carbon Steel
 Liner Polypropylene
 Diaphragm Heavy Duty Butyl Rubber
 System Connection . . . PT-25V thru PT-210V are stainless steel. All others are brass
 Factory Pre-charge 30 PSI (276 kPa)

Specifications

Model Number	Part Number	Volume Gallons (Liters)		Height (A) Inches (mm)	Diameter (B) Inches (mm)	System Connection	Approx. Shpg. Wt. lbs. (Kg)
		Tank	Acceptance				
PT-5	1BN001	2 (8)	1.0 (4)	12-5/8 (321)	8 (203)	3/4" NPTM	5 (2.3)
PT-12	1BN002	4.4 (17)	3.2 (12)	15 (381)	11 (279)		9 (4.1)
PT-25V	1BN003	10.3 (39)	10.3 (39)	19-1/4 (489)	15-3/8 (391)	1" NPTF	23 (10.4)
PT-30V	1BN004	14 (53)	11.3 (43)	23-7/8 (605)	15-3/8 (391)		25 (11.3)
PT-42V	1BN005	20 (76)	11.3 (43)	31-5/8 (802)	15-3/8 (391)		33 (15)
PT-60V	1BN006	34 (129)	34 (129)	29-5/8 (752)	22 (559)	1-1/4" NPTF	69 (31.2)
PT-80V	1BN007	44 (167)	34 (129)	36 (914)	22 (559)		69 (31.2)
PT-180V	1BN008	62 (235)	34 (129)	46-3/4 (1187)	22 (559)		92 (41.7)
PT-210V	1BN009	86 (326)	46.4 (176)	47-1/4 (1200)	26 (660)		123 (55.8)

Materials: Steel Shell, Polypropylene Liner, Buty Diaphragm
 System Connection: Brass
 Standard Factory Precharge = 40 PSI (276 kPa)
 Larger sizes and ASME constructed models are available.

Code approvals: PT-5, PT-12



PT-25V thru PT-210



Commercial Non-ASME Bladder Tanks

Maximum working pressure . . 150 PSI (1035 kPa)
 Maximum operating temperature . . 240°F (116°C)

Materials of Construction

Shell Carbon Steel
 Liner Polypropylene
 Diaphragm Heavy Duty Butyl Rubber
 System Connection Bronze
 Factory Pre-charge 55 PSI (379 kPa)

Water Heater Volume (gallons)	Supply Pressure (PSI)							
	40	50	55	60	70	80	90	100
20								
30								
40				PT-5				
50								
80								
100								
120					PT-12			

Assumptions: heating water from 50°F to 120°F, relief valve pressure 150 PSI
 PT tank precharged equal to supply line pressure, consult factory with requirements not shown

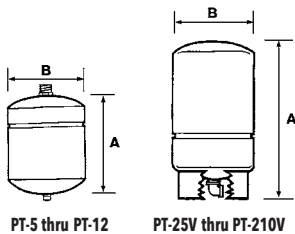

WTX Diaphragm Tanks

The Series "WTX" tanks will help protect the pump and pressure switches against short cycling. The potable well tank delivers adequate water under pressure between pump cycles to meet the required demand. It will provide economical system operation by minimizing pump starts, extending pump motor life, and saving energy. The "WTX" tank will also assist the pump in meeting peak demands.

Specifications

Model Number	Part Number	Volume Gallons (Liters)		System Drawdown in Gallons			Height (A) Inches (mm)	Diameter (B) Inches (mm)	System Connection	Approx. Shpg. Wt. lbs. (Kg)
		Tank	Acceptance	PSIG						
				20/40	30/50	40/60				
WTX-2	1BN300	2 (8)	0.45	0.8	0.7	0.6	12-5/8 (321)	8 (203)	3/4" NPTM	5 (2.3)
WTX-5	1BN301	4.4 (17)	0.55	1.8	1.5	1.3	15 (381)	11 (279)		9 (4)
WTX-8	1BN302	7.6 (33)	0.42	3.1	2.6	2.2	22-1/4 (629)	11 (279)		15 (7)
WTX-10	1BN303	10.3 (39)	1.00	4.1	3.5	3.0	17-3/4 (451)	15-3/8 (390)	1" NPTM	20 (9)
WTX-14	1BN304	14 (53)	0.81	5.6	4.8	4.1	22 (559)	15-3/8 (390)		22 (10)
WTX-10S	1BN305	10.3 (39)	1.00	4.1	3.5	3.0	19-1/4 (489)	15-3/8 (390)	1" NPTF	23 (10)
WTX-14S	1BN306	14 (53)	0.81	5.6	4.8	4.1	23-7/8 (605)	15-5/8 (390)		25 (11)
WTX-20S	1BN307	20 (76)	0.57	8.0	6.8	5.9	31-5/8 (802)	15-3/8 (390)		33 (15)
WTX-26S	1BN308	26 (98)	0.44	10.5	8.8	7.6	38-1/4 (972)	15-3/8 (390)	1-1/4" NPTM	36 (16)
WTX-32S	1BN309	32 (121)	0.35	—	10.9	9.4	46-1/2 (1181)	15-5/8 (390)		43 (20)
WTX-34S	1BN310	34 (129)	1.00	13.7	11.6	10.0	29-5/8 (752)	22 (559)	1-1/4" NPTM	61 (28)
WTX-44S	1BN311	44 (167)	0.77	17.7	15	12.9	36 (914)	22 (559)		69 (31)
WTX-62S	1BN312	62 (235)	0.55	24.9	21.1	18.2	46-3/4 (1187)	22 (559)		92 (41)
WTX-81S	1BN313	81 (307)	0.41	32.6	27.5	23.8	56-3/8 (1432)	22 (559)	1-1/4" NPTM	103 (47)
WTX-86S	1BN315	86 (326)	0.54	34.6	29.2	25.3	47-1/4 (1200)	26 (660)		123 (56)
WTX-119S	1BN316	119 (450)	0.39	47.8	40.5	35.0	61-7/8 (1572)	26 (660)		166 (75)

Materials: Steel Shell, Polypropylene Liner, Buty/EPDM Diaphragm
 System Connection: WTX-2 thru WTX-14 = Copper Lined Steel Fitting; All others = Steel with Stainless Steel Elbow
 Maximum Operating Temperature = 200°F (93°C); Maximum Working Pressure = 100 PSI (689 kPa);
 Factory Pre-Charge: WTX-2 = 18PSI (124kPa); WTX-5 = 28 PSI (193 kPa); All other WTX tanks = 38 PSI (262 kPa)

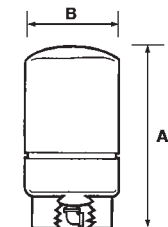

WTX-10S thru WTX-119S

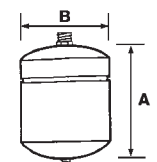

WTX-2 thru WTX-14

VALVES TPV - Tank Purge Valves

Description

Combination full port shut-off valve and drain valve used to connect an expansion tank to the system. It is important that the pre-charge in an expansion tank be maintained at the proper pressure at all times. This pressure is the lowest system operating pressure. When the tank's pressure is adjusted, there should be no system liquid in it. This pre-charge should be checked and adjusted when:

- Tank is first installed
- If system is started or operating with the incorrect tank pre-charge
- Annually to assure proper pre-charge pressure at all times

The TPV (Tank Purge Valve) is ideal for this as the tank can be isolated from the system, drained and the pre-charge checked and adjusted without draining or shutting down the system.

The TPV also serves as a service valve should the tank need to be removed or have the bladder changed. These valves are furnished standard with a drain valve with a standard 5/8" hose connection.

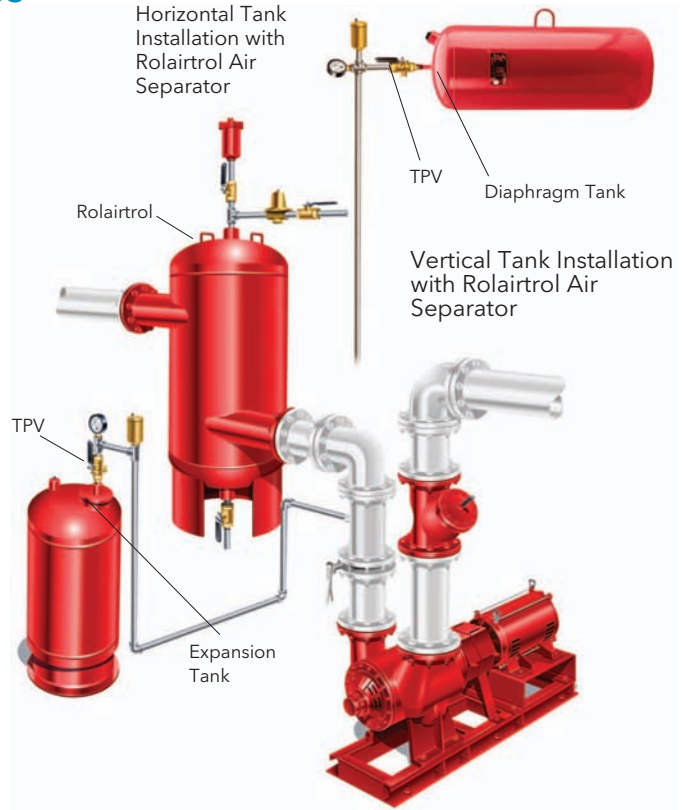

Operating Data

Maximum working pressure 400 PSIG
(2,758 kPa)

Maximum operating temperature
-4°F (-20°C) to 250°F (121°C)

Materials of Construction

Valve Body Brass
Ball Chrome Plated
Ball Seal Teflon®
Stem Explosion Proof
O-Ring EPDM

*Teflon is a registered trademark of E.I. du Pont de Nemours and Company

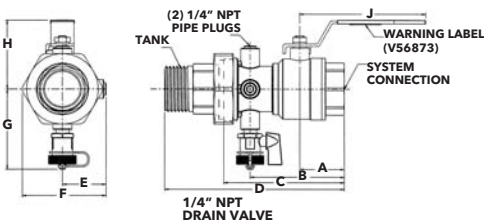

These valves are not recommended to be used on potable water tanks.

Specifications

Model Number	Part Number	System Connection	Tank Connection	Dimensions* Inch (mm)								Approx. Weight Lbs.	
				A	B	C	D	E	F	G	H		J
TPV-1/2SF	113226	1/2" Female SWT	1/2" Female NPT	1.67 (42.4)	2.25 (57.2)	3.15 (80.0)	3.82 (97.0)	0.84 (21.3)	1.60 (40.6)	2.36 (59.9)	1.75 (44.5)	3.34 (84.8)	1.0 (0.5)
TPV-1/2FF	113227	1/2" Female NPT	1/2" Female NPT	1.19 (30.2)	2.00 (50.8)	2.90 (73.7)	3.55 (90.4)	0.84 (21.3)	1.60 (40.6)	2.36 (59.9)	1.75 (44.5)	3.34 (84.8)	1.0 (0.5)
TPV-1/2SM	113228	1/2" Female SWT	1/2" Male NPT	1.29 (32.2)	2.25 (57.2)	3.15 (80.0)	4.73 (120.1)	0.84 (21.3)	1.60 (40.6)	2.36 (59.9)	1.75 (44.5)	3.34 (84.8)	1.0 (0.5)
TPV-1/2FM	113229	1/2" Female NPT	1/2" Male NPT	1.06 (26.9)	2.00 (50.6)	2.90 (73.7)	4.47 (113.6)	0.84 (21.3)	1.60 (40.6)	2.36 (59.9)	1.75 (44.5)	3.34 (84.8)	1.0 (0.5)
TPV-3/4SF	113230	3/4" Female SWT	3/4" Female NPT	1.67 (42.2)	2.85 (72.4)	3.72 (94.5)	4.53 (115.9)	1.06 (26.9)	1.95 (49.5)	2.66 (67.6)	1.89 (48.0)	3.50 (88.9)	1.24 (0.6)
TPV-3/4FF	113231	3/4" Female NPT	3/4" Female NPT	1.19 (30.2)	2.50 (63.5)	3.26 (82.8)	4.06 (103.1)	1.06 (26.9)	1.95 (49.5)	2.66 (67.6)	1.69 (48.0)	3.50 (88.9)	1.24 (0.6)
TPV-3/4SM	113232	3/4" Female SWT	3/4" Male NPT	1.67 (42.4)	2.85 (72.4)	3.72 (94.5)	5.50 (140.0)	1.06 (26.9)	1.95 (49.5)	2.66 (67.6)	1.69 (48.0)	3.50 (88.9)	1.25 (0.6)
TPV-3/4FM	113233	3/4" Female NPT	3/4" Male NPT	1.19 (30.2)	2.50 (63.5)	3.26 (82.8)	5.03 (127.6)	1.06 (26.9)	1.95 (49.5)	2.66 (67.6)	1.69 (48.0)	3.50 (88.9)	1.25 (0.6)
TPV-1SF	113234	1" Female SWT	1" Female NPT	1.95 (49.5)	3.18 (80.6)	4.14 (105.2)	5.05 (126.3)	1.23 (31.2)	2.06 (52.3)	2.71 (68.6)	2.00 (50.8)	4.00 (101.6)	1.71 (0.8)
TPV-1FF	113235	1" Female NPT	1" Female NPT	1.46 (36.8)	2.63 (66.5)	3.60 (91.4)	4.50 (114.3)	1.23 (31.2)	2.06 (52.3)	2.71 (68.6)	2.00 (50.8)	4.00 (101.6)	1.71 (0.8)
TPV-1SM	113236	1" Female SWT	1" Male NPT	1.95 (49.5)	3.18 (80.6)	4.14 (105.2)	6.16 (156.5)	1.23 (31.2)	2.06 (52.3)	2.71 (68.6)	2.00 (50.8)	4.00 (101.6)	1.75 (0.8)
TPV-1FM	113237	1" Female NPT	1" Male NPT	1.45 (36.8)	2.53 (60.8)	3.60 (91.4)	5.60 (142.2)	1.23 (31.2)	2.06 (52.3)	2.71 (68.6)	2.00 (50.8)	4.00 (101.6)	1.75 (0.8)
TPV-1 1/4SF	113238	1 1/4" Female SWT	1 1/4" Female NPT	2.13 (54.1)	3.94 (100.1)	5.14 (130.6)	6.10 (154.9)	1.34 (34.0)	2.71 (68.8)	2.96 (75.2)	2.45 (62.2)	4.50 (114.3)	3.15 (1.5)
TPV-1 1/4FF	113239	1 1/4" Female NPT	1 1/4" Female NPT	1.55 (39.4)	3.37 (85.6)	4.56 (115.6)	5.50 (139.7)	1.34 (34.0)	2.71 (68.8)	2.96 (75.2)	2.45 (62.2)	4.50 (114.3)	3.15 (1.5)
TPV-1 1/4SM	113240	1 1/4" Female SWT	1 1/4" Male NPT	2.13 (54.1)	3.94 (100.1)	5.14 (130.6)	7.11 (180.6)	1.34 (34.0)	2.71 (68.8)	2.96 (75.2)	2.45 (62.2)	4.50 (114.3)	3.19 (1.5)
TPV-1 1/4FM	113241	1 1/4" Female NPT	1 1/4" Male NPT	1.55 (39.4)	3.37 (85.6)	4.56 (115.6)	6.52 (165.6)	1.34 (34.0)	2.71 (68.8)	2.96 (75.2)	2.45 (62.2)	4.50 (114.3)	3.19 (1.5)
TPV-1 1/2SM	113242	1 1/2" Female SWT	1 1/2" Male NPT	2.54 (84.5)	4.66 (118.4)	5.90 (149.9)	8.32 (211.3)	1.85 (47.0)	3.25 (82.6)	3.38 (85.9)	3.00 (76.2)	5.30 (134.5)	5.50 (2.5)
TPV-1 1/2FM	113243	1 1/2" Female NPT	1 1/2" Male NPT	1.91 (48.5)	3.97 (100.8)	5.12 (130.1)	7.64 (194.1)	1.85 (47.0)	3.25 (82.6)	3.38 (85.9)	3.00 (76.2)	5.30 (134.5)	5.50 (2.5)
TPV-2SM	113244	2" Female SWT	2" Male NPT	2.89 (72.4)	4.57 (116.1)	6.80 (172.7)	9.80 (248.9)	2.00 (50.8)	4.00 (101.6)	3.52 (89.4)	3.33 (84.6)	6.12 (155.5)	8.00 (3.63)
TPV-2FM	113245	2" Female NPT	2" Male NPT	2.06 (62.3)	4.65 (118.1)	5.85 (148.6)	8.87 (225.3)	2.00 (50.8)	4.00 (101.6)	3.52 (89.4)	3.33 (84.6)	6.12 (155.5)	8.00 (3.63)

*All dimensions +/- 0.125 (3.2 mm) tolerance. Dimensions are subject to change. Not to be used for construction purposes unless certified.

HEAT EXCHANGERS Brazed Plate Heat Exchangers

Description

Model BPX brazed plate heat exchangers offer the highest level of thermal efficiency and durability in a compact, low cost unit. The corrugated plate design provides very high heat transfer coefficients, resulting in a more compact design. The unit's stainless steel plates are vacuum brazed together to form a durable, integral piece that can withstand high pressure and temperature.

The BPX heat exchangers offer a compact design compared to shell and tube exchangers

- 1/6 the size of shell and tube
- 1/5 the weight of shell and tube
- 1/8 the liquid required of shell and tube
- 1/3 to 1/5 of the surface area required

BPX units are ideal for a wide variety of hydronic applications such as:

- Radiant Floor Heating
- Domestic Water Heating
- Snow MELT Systems
- Swimming Pool Heating

Operating Data

Design pressure 435 PSI (30 bar)
 Design temperature 450°F (232°C)
 Plates Stainless Steel
 Braze Material Copper
 Connections From 1/2 inch to 4 inch
 Capacity Up to 800 GPM
 Construction Codes UL, CRN, ASME Code Stamp Option



Also available in double-wall design.

Designed for dependability – Small size. Big impact.

Mechanical Design:

Design pressures up to 435 PSIG.
 Maximum design temperature up to 450°F. Minimum design temperature to -310°F.

Construction Codes:

Available codes include UL, CRN, and ASME code stamp.

Materials:

Stainless steel 316L plates.
 Copper brazed material.



Connections:

From 1/2-inch to 4-inch. Standard connection options include NPT, SAE flanged and sweat. Custom connections available.

Capacity:

Up to 800 GPM and 350 sq.ft. of surface area.

Mounting:

Reduce mounting costs with optional threaded studs or integral mounting bracket.



HEAT EXCHANGERS Brazed Plate Heat Exchangers

Quick Selection Tables



Domestic Water Heating							
Boiler Side: Water 180° F supply, 130° F return Domestic Water Side: Water 50° F supply, 140° F return							
Model	Heat Exchanged BTU/Hr	Boiler Side		Domestic Water Side		B&G Pump Selection ¹	Pipe Size ^{††}
		Flow GPM	Pressure Drop PSI	Flow GPM	Pressure Drop PSI		
BP400-10 (¾" MPT)	60,000	2.5	1.6	1.3	0.3	NBF-9U	¾"
BP400-20 (¾" MPT)	150,000	6.2	2.1	3.3	0.6	NBF-9U	¾"
BP400-30 (¾" MPT)	225,000	9.3	2.2	5.0	0.7	NBF-9U	1"
BP400-40 (¾" MPT)	350,000	14.4	3.4	7.8	1.0	NBF-12	1¼"
BP410-30 (1" MPT)	450,000	18.6	6.2	10.0	1.8	NBF-25	1¼"
BP410-40 (1" MPT)	600,000	24.8	6.2	13.3	2.0	NBF-25	1½"
BP410-50 (1" MPT)	800,000	33.0	6.9	17.8	2.4	NBF-25	1½"
BP410-60 (1" MPT)	900,000	37.1	6.9	20.0	2.2	NBF-25	2"
BP410-80 (1" MPT)	1,100,000	45.4	6.8	24.4	2.2	NBF-36	2"
BP423-30 (2" MPT)	1,500,000	61.9	4.6	33.3	1.4	NBF-45	2"
BP423-40 (2" MPT)	2,000,000	82.5	4.6	44.4	1.4	PL-45B	2½"
BP423-50 (2" MPT)	2,500,000	103.1	4.8	55.5	1.5	PL-75B	2½"

Larger models are available upon request. † Assumptions: 200 ft. TEL of copper pipe with (6) 90 degree elbows. †† Pipe size shown is not the connection size of the heat exchanger.

Snow Melt Applications							
Boiler Side: Water 180° F supply, 160° F return Snow Side: Water 40% P.G. 100° F supply, 130° F return							
Model	Heat Exchanged BTU/Hr	Boiler Side		Snow Melt Side		B&G Pump Selection ¹	Pipe Size ^{††}
		Flow GPM	Pressure Drop PSI	Flow GPM	Pressure Drop PSI		
BP400-10 (¾" MPT)	30,000	3.1	2.4	2.1	0.9	NRF-25	¾"
BP400-10 (¾" MPT)	45,000	4.6	5.1	3.2	2.1	NRF-35	¾"
BP400-14 (¾" MPT)	60,000	6.2	4.2	4.3	1.9	NRF-25	1"
BP400-20 (¾" MPT)	100,000	10.3	5.4	7.1	2.7	NRF-36	1"
BP400-40 (¾" MPT)	175,000	18.0	5.2	12.5	2.8	NRF-36	1½"
BP412-30 (1" MPT)	250,000	25.8	4.1	17.9	2.1	PL-36	1½"
BP412-30 (1" MPT)	300,000	30.9	5.8	21.4	2.9	PL-55	2"
BP412-50 (1" MPT)	450,000	46.4	6.2	32.1	3.3	613	2"
BP424-20 (2" MPT)	600,000	61.8	4.8	42.9	2.8	609	2"
BP424-30 (2" MPT)	900,000	92.7	4.8	64.3	3.0	614	2½"
BP424-40 (2" MPT)	1,200,000	123.6	5.1	85.7	3.2	625	3"
BP424-50 (2" MPT)	1,350,000	139.1	4.7	96.4	2.9	625	3"

Larger models are available upon request.
† Assumptions: Longest radiant loop is 250 ft. PEX.
†† Pipe size shown isn't the connection size of the heat exchanger.

Outdoor Wood Boiler						
Boiler Side: Water 180° F supply, 155° F return House Side: Water 140° F supply, 165° F return						
Model	Heat Exchanged BTU/Hr	Boiler Side		House Side		Pipe Size ^{††}
		Flow GPM	Pressure Drop PSI	Flow GPM	Pressure Drop PSI	
BP400-20LP (¾" MPT)	30,500	2.52	0.4	2.5	0.3	
BP400-30LP (¾" MPT)	50,000	4.12	0.5	4.1	0.4	
BP400-40LP (¾" MPT)	70,000	5.77	0.6	5.7	0.6	
BP410-20LP (1" MPT)	80,000	6.60	1.9	6.5	1.6	
BP410-30LP (1" MPT)	130,000	10.72	2.2	10.6	1.92	
BP410-40LP (1" MPT)	179,500	14.80	2.3	14.6	2.2	
BP410-50LP (1" MPT)	229,500	18.92	2.5	18.7	2.4	
BP410-60LP (1" MPT)	279,000	23.00	2.8	22.8	2.6	
BP410-70LP (1" MPT)	329,000	27.13	3.0	26.8	2.9	
BP410-80LP (1" MPT)	378,500	31.21	3.3	30.9	3.2	
BP410-90LP (1" MPT)	428,500	35.33	3.7	34.9	3.6	
BP410-100LP (1" MPT)	478,000	39.41	4.0	39.0	4.0	

Larger models are available upon request.

Swimming Pool Heating						
Boiler Side: Water 180° F supply, 130° F return Pool Side: Water 70° F supply, 107° F return						
Model ³	Pool Size Gallons ¹	Heat Exchanged BTU/Hr	Boiler Side		Pool Side	
			Flow GPM	Pressure Drop PSI	Flow ² GPM	Pressure Drop PSI
BP400-10 (¾" MPT)	2,000	33,300	1.37	0.5	1.8	0.6
BP400-10 (¾" MPT)	6,000	99,900	4.10	4.1	5.4	5.0
BP400-20 (¾" MPT)	8,000	133,200	5.50	1.7	7.3	2.5
BP400-30 (¾" MPT)	15,000	250,234	10.00	2.7	14.0	4.5
BP412-20 (1" MPT)	20,000	333,645	13.00	2.5	18.0	3.4
BP412-20 (1" MPT)	30,000	500,467	20.70	5.6	27.2	7.7
BP412-30 (1" MPT)	40,000	667,290	27.00	3.9	36.0	6.9
BP424-20 (2" MPT)	60,000	1,000,936	40.00	2.3	54.0	3.6
BP424-30 (2" MPT)	80,000	1,334,581	53.00	1.9	72.0	3.1
BP424-30 (2" MPT)	100,000	1,668,226	67.00	2.8	90.0	4.7
BP424-40 (2" MPT)	120,000	2,001,871	82.50	2.5	108.0	4.2
BP424-50 (2" MPT)	150,000	2,502,000	103.20	2.7	135.6	4.7

Larger models are available upon request.
1) Provides approx. 2° F per hour heating with 180° F boiler to achieve 80° F pool temperature.
2) Pool water flow rate usually requires flow by pass from main pool circulation.
3) Chlorinated pool water can be corrosive to SS316L and Copper. Proper control of chlorine levels is required or alternate materials of construction should be considered.

Radiant Heating							
Boiler Side: Water 180° F supply, 160° F return Radiant Floor Side: Water 100° F supply, 120° F return							
Model	Heat Exchanged BTU/Hr	Boiler Side		Radiant Floor Side		B&G Pump Selection ¹	Pipe Size ^{††}
		Flow GPM	Pressure Drop PSI	Flow GPM	Pressure Drop PSI		
BP400-10 (¾" MPT)	30,000	3.1	2.4	3.0	1.6	NRF-25	¾"
BP400-10 (¾" MPT)	50,000	5.2	6.1	5.0	4.2	NRF-36	1"
BP400-20 (¾" MPT)	100,000	10.3	5.2	10.1	4.4	NRF-36	1¼"
BP400-30 (¾" MPT)	150,000	15.5	5.3	15.2	4.9	NRF-36	1½"
BP400-40 (¾" MPT)	200,000	20.6	5.8	20.2	5.5	NRF-36	1½"
BP411-20 (1" MPT)	250,000	25.8	3.3	25.2	3.0	PL-36	2"
BP411-20 (1" MPT)	350,000	36.1	6.3	35.3	5.6	PL-55	2"
BP411-30 (1" MPT)	450,000	46.4	6.1	45.4	5.8	607	2"
BP424-20 (2" MPT)	600,000	61.8	4.8	60.6	4.2	609	2½"
BP424-30 (2" MPT)	900,000	92.7	4.8	90.9	4.5	611	3"
BP424-40 (2" MPT)	1,200,000	123.6	5.1	121.2	5.0	625	3"
BP424-50 (2" MPT)	1,350,000	139.1	4.7	136.3	4.6	619	3"

Larger models are available upon request.
† Assumptions: Longest radiant loop is 200 ft. PEX.
†† Pipe size shown isn't the connection size of the heat exchanger.

Wastewater Sump, Effluent and Wastewater Pumps

A complete offering of submersible wastewater pumps that reliably dispose of drainage and waste quickly and efficiently.



Sump Pumps

- Sump pumps are specifically designed for basement draining, dewatering and water transfer.
- Range of capacities up to 70 GPM and maximum heads of 37 TDH ranging from 1/4HP to 3/4 HP.
- Construction of cast iron or stainless steel available with 1-1/2" discharge connections.
- Offering of battery back-up sump pumps also available for emergency back up service in the event of a power outage.

Effluent Pumps

- Effluent pumps designed for applications such as effluent systems in residential to commercial systems including homes, farms, hospitals, trailer courts, motels as well as heavy duty sump, water transfer and dewatering applications.
- Suitable for handling solids up to 3/4" with a range of capacities up to 140 GPM and 128 TDH.
- Construction available in cast iron, stainless steel and plastic models.

Sewage Pumps

- Non-Clog sewage pumps for simplex and duplex installations in lift stations, drainage systems or raw water applications that require solids handling.

- Applications include homes and farms, schools and hospitals, municipal systems, mobile homes parks and motels as well as industrial treatment systems.
- Sewage pump designs include channel non-clog and vortex designs in constructions of cast iron and stainless steel.
- Models range with flows up to 620 GPM and maximum 80 TDH.
- Offering includes discharge sizes from 1-1/2" up to 4".

Grinder Pumps

- Grinder pumps designed for high head residential sewage applications where gravity systems are not practical.
- Capacities up to 41 GPM and 95 TDH.
- Discharge connection of 1-1/4" in cast iron construction.

Packages and accessories

- Complete package systems designed for sink drain systems and sewage lift stations.
- Centripro® accessories include control panels, float switches, basins/ covers, pump removal systems fittings for complete system needs.

Genuine Bell & Gossett Parts

When replacing parts in your customers' B&G booster or other hydronic specialties, don't settle for anything other than genuine B&G parts. You owe it to your customers and to yourself to do it right the first time.

Bell & Gossett parts are designed and engineered strictly for the Bell & Gossett boosters. Substitute parts may seem to cost less. But more often than not, they actually cost a lot more, when they do not hold up on the job. Then you are faced with callbacks and your reputation is at stake.

So why risk having to replace a replacement part? Stick with the real thing – from Bell & Gossett.

Visit our website at www.xylem.com/brands/bellgossett. Go to ESP Plus and click on Sizing & Selection Tools to use ESP Parts, to view an exploded drawing and bill of material.



B&G designs our own motors to exacting circulating pump specifications.



B&G bearing assembly bracket. Restores pump to like new conditions.



B&G flexible spring coupler dampens vibration and noise.

The Little Red Schoolhouse® - Training the Industry



Seminars currently offered are:

- Modern Hydronic System Design - Basic
- Modern Hydronic System Design - Advanced
- Design & Application of Water Based HVAC Systems
- Large Chilled Water System Design
- Pump Service & Maintenance School
- Steam Systems Design & Applications
- Steam System Operation & Maintenance

Bell & Gossett has long been known for its dedication to training. The "Little Red Schoolhouse" has graduated over 50,000 students since it was founded in 1954.

Graduates from the "Little Red Schoolhouse" may be found in every state of the Union as well as Europe, Africa, Asia and Australia.

For applications to attend these seminars, please contact a Bell & Gossett Representative in your area. They will have the schedule dates for all seminars and will make all the arrangements for you. As a service and a continuing educational source to the HVAC industry, these seminars are offered free of charge. CEU credits are awarded for each seminar as indicated.

Xylem |'zīləm|

- 1) The tissue in plants that brings water upward from the roots;
- 2) a leading global water technology company.

We're 12,000 people unified in a common purpose: creating innovative solutions to meet our world's water needs. Developing new technologies that will improve the way water is used, conserved, and re-used in the future is central to our work. We move, treat, analyze, and return water to the environment, and we help people use water efficiently, in their homes, buildings, factories and farms. In more than 150 countries, we have strong, long-standing relationships with customers who know us for our powerful combination of leading product brands and applications expertise, backed by a legacy of innovation.

For more information on how Xylem can help you, go to www.xyleminc.com



Xylem Inc.
8200 N. Austin Avenue
Morton Grove, Illinois 60053
Phone: (847) 966-3700
Fax: (847) 965-8379
www.xyleminc.com/brands/bellgossett

Bell & Gossett is a trademark of Xylem Inc. or one of its subsidiaries.
© 2011 Xylem Inc. A-50M January 2012